

Bureau of Indian Affairs

Office of Facilities Management and Construction



SCHOOL FACILITIES DESIGN HANDBOOK

March 30, 2007

**BUREAU OF INDIAN AFFAIRS
SCHOOL FACILITIES DESIGN HANDBOOK**

TABLE OF CONTENTS

1.	GENERAL INFORMATION	
	GENERAL	1000-1
	USING THE BIA HANDBOOK AND SPACE TEMPLATES	1010-1
	SCHOOL FACILITY DESIGN PHILOSOPHY	1020-1
	CULTURAL DESIGN PHILOSOPHY	1030-1
	CODES, STANDARDS, AND LAWS	1040-1
	BIE EDUCATIONAL SPACE CRITERIA HANDBOOK	1050-1
	ABBREVIATIONS	1060-1
2.	PRESENTATION OF DATA	
	GENERAL	2000-1
	CONSULTANT SUBMITTAL REQUIREMENTS	2010-1
	DOCUMENT REVIEW AND COORDINATION	2020-1
	DESIGN ANALYSIS	2030-1
	DRAWINGS	2040-1
	SPECIFICATIONS	2050-1
	COST ESTIMATING	2060-1
3.	LEED GOALS AND GUIDELINES	
	GENERAL	3000-1
	BIA OBJECTIVES AND REQUIREMENTS	3010-1
	LEED-NC GREEN BUILDING RATING SYSTEM	3020-1
	LEED-NC CERTIFICATION REQUIREMENTS	3030-1
4.	SITE DESIGN	
	GENERAL	4000-1
	CODES, STANDARDS, AND LAWS	4010-1
	SITE DESIGN PRINCIPLES AND CONCEPTS	4020-1
	VEHICULAR CIRCULATION	4030-1
	EMERGENCY ACCESS AND CIRCULATION	4040-1
	SERVICE AREAS	4050-1
	HARDSCAPE AREAS	4060-1
	PLAY AND RECREATION AREAS	4070-1
	FENCING	4080-1
	GEOTECHNICAL EVALUATION	4090-1
5.	CIVIL	
	GENERAL	5000-1
	CIVIL SELECTION CRITERIA	5010-1
	CODES, STANDARDS, AND LAWS	5020-1
	SITE DESIGN AND EARTHWORK	5030-1

Table of Contents

EROSION CONTROL 5040-1
UTILITY INFRASTRUCTURE 5050-1
WATER SYSTEMS..... 5060-1
WASTEWATER SYSTEMS 5070-1
STORM DRAINAGE..... 5080-1
ROADS..... 5090-1
PAVING..... 5100-1

6. LANDSCAPE DESIGN
GENERAL 6000-1
LANDSCAPE MATERIALS SELECTION CRITERIA 6010-1
CODES, STANDARDS, AND LAWS 6020-1
LANDSCAPE AREAS 6030-1
WATER CONSERVATION AND IRRIGATION..... 6040-1
SOIL, SOIL AMENDMENTS, AND MULCH..... 6050-1
INTEGRATED WEED, DISEASE, AND PEST MANAGEMENT 6060-1

7. ARCHITECTURAL
GENERAL 7000-1
ARCHITECTURAL SYSTEMS SELECTION CRITERIA..... 7010-1
CODES, STANDARDS, AND LAWS 7020-1
MOVEABLE AND FIXED FURNITURE/EQUIPMENT 7030-1
ACOUSTICS 7040-1
EXTERIOR WALL SYSTEMS..... 7050-1
ROOFING SYSTEMS..... 7060-1
INTERIOR PARTITIONS 7070-1
ROOF DRAINAGE 7080-1
THERMAL AND MOISTURE PROTECTION..... 7090-1
GLAZING SYSTEMS..... 7100-1
DAYLIGHTING STRATEGIES 7110-1
DOOR SYSTEMS 7120-1
SIGNAGE SYSTEMS 7130-1
TRAINING..... 7140-1

8. INTERIORS
GENERAL 8000-1
INTERIOR FINISH SYSTEMS SELECTION CRITERIA 8010-1
CODES, STANDARDS, AND LAWS 8020-1
FINISHES 8030-1
PUBLIC CORRIDORS 8040-1

9. STRUCTURAL
GENERAL 9000-1
STRUCTURAL SYSTEMS SELECTION CRITERIA 9010-1
CODES, STANDARDS, AND LAWS 9020-1
STRUCTURAL SYSTEMS CONSIDERATIONS 9030-1

	FLOOR SYSTEMS.....	9040-1
	ROOF FRAMING SYSTEMS	9050-1
	LATERAL LOAD RESISTING SYSTEMS	9060-1
	VERTICAL ELEMENTS	9070-1
	STRUCTURAL WALLS	9080-1
	APPURTENANCES	9090-1
10.	MECHANICAL	
	GENERAL	10000-1
	MECHANICAL SYSTEMS SELECTION CRITERIA	10010-1
	CODES, STANDARDS, AND LAWS	10020-1
	HEATING, VENTILATION, AND AIR-CONDITIONING SYSTEMS.....	10030-1
	TEMPERATURE CONTROL AND ENERGY MANAGEMENT SYSTEM.....	10040-1
	PLUMBING.....	10050-1
	TRAINING.....	10060-1
11.	ELECTRICAL	
	GENERAL	11000-1
	ELECTRICAL SYSTEMS SELECTION CRITERIA	11010-1
	CODES, STANDARDS, AND LAWS	11020-1
	EXTERIOR UTILITIES	11030-1
	ELECTRICAL SYSTEM DESIGN	11040-1
	GROUNDING SYSTEM.....	11050-1
	INTERIOR LIGHTING SYSTEMS	11060-1
	EXTERIOR LIGHTING SYSTEMS	11070-1
	LIGHTING CONTROLS	11080-1
	SPECIAL ELECTRICAL SYSTEMS	11090-1
	FIRE ALARM SYSTEM.....	11100-1
	EMERGENCY AND STANDBY POWER SYSTEMS.....	11110-1
	LIGHTNING PROTECTION.....	11120-1
	COMMISSIONING	11130-1
	TRAINING.....	11140-1
	OPERATING AND MAINTENANCE MANUALS.....	11150-1
	ELECTRICAL STANDARD DETAILS.....	11160-1
12.	FIRE PROTECTION	
	GENERAL	12000-1
	FIRE PROTECTION SYSTEMS SELECTION CRITERIA.....	12010-1
	CODES, STANDARDS, AND LAWS	12020-1
	SYSTEM REQUIREMENTS.....	12030-1
	FIRE PROTECTION EXHIBITS AND DETAILS	12040-1
13.	INFORMATION TECHNOLOGY	
	GENERAL	13000-1
	IT SYSTEMS SELECTION CRITERIA	13010-1
	CODES, STANDARDS, AND LAWS	13020-1

Table of Contents

COMMUNICATIONS ROOMS AND SPACES.....	13030-1
COMMUNICATIONS CABLING.....	13040-1
COMMUNICATIONS PATHWAYS	13050-1
COMMUNICATIONS GROUNDING AND BONDING	13060-1
OUTSIDE CONNECTIVITY	13070-1
SECURITY.....	13080-1
ROOM TECHNOLOGY	13090-1
DATA NETWORK.....	13100-1
TELEPHONE/INTERCOM.....	13110-1
PUBLIC ADDRESS/BELL.....	13120-1
CLOCK SYSTEM	13130-1
RADIO SYSTEM.....	13140-1
TRAINING.....	13150-1
14. KITCHEN DESIGN	
GENERAL	14000-1
DESIGN CONSIDERATIONS.....	14010-1
CODES, STANDARDS, AND LAWS	14020-1
WORK FLOW	14030-1
SQUARE FOOTAGE REQUIREMENTS	14040-1
EXAMPLE KITCHEN LAYOUT PLANS	14050-1
AREA REQUIREMENTS	14060-1
FABRICATION OF METALWORK.....	14070-1

1000-1. Introduction

- 1.1. To ensure that Native American children are afforded a modern educational environment that is in keeping with national standards, safe, functional, flexible for changing needs, and culturally adaptive, the Bureau of Indian Affairs (BIA) Office of Facilities Management and Construction (OFMC) has developed the *BIA School Facilities Design Handbook*. In this handbook, standardized procedures for design, drawings, specifications, design analysis, cost estimates, and related support tasks for new BIA school facilities are provided.
- 1.2. As a companion to the *BIA School Facilities Design Handbook*, OFMC has also created the *BIA School Facilities Space Templates*. This volume contains the diagrammatic information necessary to develop the functional floor plans of BIA educational facilities using approved components, and provides specific programmatic criteria for each space.

1000-2. Program Goals

- 2.1. The BIA's primary goals for the handbook and space templates include the following:
 - Design of facilities that reflect the importance of cultural expression
 - Equality of educational environment among BIA schools throughout the United States
 - Sustainable design, through incorporation of the U.S. Green Building Council's LEED program, with the requirement of LEED Silver certification for all projects
 - Standardization of individual spaces and their programmatic requirements without dictating building aesthetics

1000-3. Program Overview

- 3.1. The BIA is responsible for providing facilities to support educational programs for eligible Indian School Equalization Program (ISEP) students. Its central, stated goal is to provide a high-quality educational environment for Native American children from kindergarten through high school.
- 3.2. In order to meet this goal in a cost-efficient manner, and to ensure equality among all its new educational facilities, the BIA seeks to standardize the design and construction of its schools while still allowing for individual needs and cultural expression. Following are the specific standardization goals of the BIA, and the ways they have been addressed in this handbook and the space templates:
 - 3.2.1. *The Design Process.* To ensure a consistent design process from project to project, the procedures to be followed by the design team during the design phase of BIA school facilities are carefully spelled out. These guidelines include project submittal requirements, required drawing information, and the required format for specifications.

- 3.2.2. *Programmatic Areas.*** Standardized layouts of individual programmatic areas, seen in the space templates, are provided to control design costs and ensure consistency without unduly limiting the design team's creativity in the overall layout and design of the school. Relationship diagrams are provided to indicate the overall organization of the school and of the areas within it.
- 3.2.3. *Construction Methods and Building Systems.*** The design team can choose from a variety of construction methods and building systems, appropriate to different regions of the country, that have received prior BIA approval. Standardization of building systems and construction options controls costs and enables the BIA to optimize maintenance procedures and requirements and the training of facilities maintenance personnel.

1010-1. General

- 1.1. To make best use of the handbook and space templates, all team members should first review both volumes and be sure they understand not only the general information and the sections related to their particular design discipline, but also how the disciplines interrelate. To ensure a successful project, and to achieve the LEED goals required by the BIA and specified in this handbook, the various Designers of Record must coordinate their efforts and develop project strategies as a team.

1010-2. Scope and Applicability of the Design Handbook and Space Templates

- 2.1. The *School Facilities Design Handbook* and the *School Facilities Space Templates* are to be used in the design of all new educational facilities funded by the Bureau of Indian Affairs, to include projects with tribes and tribal organizations.

1010-3. Codes, Standards, and Laws

- 3.1. The codes, standards, and laws identified in this handbook must be followed as they apply to individual projects. Alternative codes and standards may not be substituted without special approval from the OFMC. Such approval must be requested and received in writing.

1010-4. Conflicts, Questions, and Appeals

- 4.1. Where conflicts or questions arise pertaining to information presented in this handbook or in the space templates, the Designer of Record is to notify the BIA Contracting Officer in writing. The BIA Contracting Officer will review questions and forward decisions to the Designer of Record.

1010-5. Design Process

- 5.1. This handbook provides a general process for building and site design. The companion volume provides templates for building organization based on different grade level school models and dormitory models. These spatial relationship diagrams are meant to illustrate some ways that schools and dormitories can be organized but are by no means all-inclusive.
- 5.2. In general, design teams are required to adhere to the layouts shown in the space templates. Alternative room arrangements may be used where necessary because of building geometry; however, such deviations should be limited.

1010-6. Building and Site Systems Selection Process

- 6.1. In many cases, several building systems are provided from which the design team can select. In choosing building systems, design teams must analyze the systems relative to the specific parameters of the project, including location, availability of materials, costs, etc. If options are not provided, the design team shall utilize the system described. Should building systems be required that are not discussed in this handbook, the design team should coordinate with the BIA concerning recommendations and selections.

THIS PAGE INTENTIONALLY LEFT BLANK

1020-1. School Facility Design Philosophy

- 1.1. Because the needs of each school population may be different, and different schools may have different educational philosophies, these guidelines for future BIA schools allow for flexibility within a framework. This handbook establishes layouts and systems that can be used as needed to ensure a high-level educational, living, and working environment.
- 1.2. The arrangement of the spaces, based on both philosophy and cultural expression, is left up to the design team.
- 1.3. To meet the stated goal of the BIA to provide high-quality educational and living environments in its schools, the design handbook and space templates specify quality building materials, building systems, and physical environments. The focus on LEED goals and sustainable design supports the overall goal of building and operating high-performance buildings.

THIS PAGE INTENTIONALLY LEFT BLANK

1030-1. Cultural Design Philosophy

1.1. The BIA considers it vital to integrate cultural expression into their school facilities. The following are examples of ways that may be done:

1.1.1. Architectural Design

- Develop a cultural focal point for the community. In the school this may include a cultural classroom, media center, cafeteria, or other gathering area. In the dormitories, this may include the living room, study rooms, activity room, etc.
- Arrange the facility on the site in a way that is respectful of tribal values. This may include arranging buildings according to the four compass positions and with regard to existing site features and the surrounding landscape.
- Select exterior and interior building materials with awareness of the colors and patterns that reflect tribal values, traditions, storytelling, or traditional arts and crafts.
- Use natural daylighting strategies to ensure a strong connection between earth and sky.
- Include areas for the display of artwork throughout the facility.
- Arrange classrooms to allow for many ways of teaching children, including traditional tribal teaching methods.
- Incorporate sustainable design strategies that acknowledge the value indigenous peoples place on their environment.

1.1.2. Landscape Design

- Provide for outdoor learning environments.
- Incorporate traditional outdoor spaces.
- Incorporate sustainable landscape design strategies that are in harmony with the existing natural environment.

1.1.3. Civil Design

- Integrate the site and building design with existing topography and landforms.
- Leave existing land undisturbed as much as possible and place construction on previously disturbed land.

1.1.4. Structural Design

- Follow sustainable design principles.

1.1.5. *Mechanical Design*

- Follow sustainable design principles.

1.1.6. *Electrical Design*

- Reduce dependence on artificial illumination by incorporating natural daylighting throughout.
- Follow sustainable design principles.

1040-1. General

- 1.1. The codes, standards, and laws listed in this section are those used nationwide by the BIA for its educational facilities. All BIA school facilities and related structures shall conform to the current versions of the codes and standards that appear in this section.
- 1.2. Where two codes, standards, or laws are applicable to the topic under review, use the more conservative or more stringent. Consult with the BIA Office of Facilities Management and Construction (OFMC) to resolve any questions or conflicts regarding application of codes and standards.
- 1.3. The BIA's Division of Safety and Risk Management (DSRM) shall have document review authority for compliance with all applicable codes, standards, and laws.
- 1.4. The DSRM or its authorized representative is to inspect the facility after construction to verify that it meets applicable codes and standards.

1040-2. Applicable Codes and Standards

- 2.1. **Occupational Safety & Health Administration (OSHA) Compliance.** All operations, new construction, major alterations and improvements, minor remodeling, and workplace sites shall comply with all Occupational Safety and Health Standards issued under Section 6 of the Occupational Safety and Health Act of 1970, as well as amended or alternative standards issued pursuant to that section.
- 2.2. **Fire and Fire Safety.** All new construction, major alterations and improvements, and minor remodeling shall be classified according to occupancy and/or use and shall conform to the National Fire Code and the BIA's *25 IAM Indian Affairs Manual – Safety and Occupational Health Program*. All BIA-owned buildings, regardless of occupancy, that exceed 2,000 square feet in gross floor area shall be provided with automatic sprinkler protection in accordance with National Fire Protection Association (NFPA) 13 Ordinary Hazard classification.
- 2.3. **Accommodations for People with Disabilities.** All new construction, major alterations, and improvements shall be in accordance with the Americans with Disabilities Act and Architectural Barriers Act Accessibility Guidelines (ADAABAAG). Additionally, Section 504, Rehabilitation Act of 1973, as amended in 1978, and USCA Title 29 § 794, "Nondiscrimination under Federal Grants and Programs" establish that individuals with disabilities shall not be excluded from participation in, be denied the benefits of, or be subjected to discrimination under any program or activity receiving federal financial assistance.
 - 2.3.1. ADAABAAG has separate Americans with Disability Act (ADA) and Architectural Barriers Act (ABA) application, administration, and scoping requirements. These are found in the respective ADA and ABA Chapters 1

and 2. Technical Chapters 3–10 apply to both ADA and ABA, as referenced from their respective scoping chapters.

- 2.3.2.** The General Services Administration (GSA) has adopted ABA Chapters 1, 2, and the ADAABAAG Chapters 3–10 technical requirements referenced by Chapter 2. These form the Architectural Barriers Act Accessibility Standard (ABAAS), which must be followed by all bureaus in the Department of the Interior, including the Bureau of Indian Affairs and the Bureau of Indian Education.
- 2.3.3.** By U.S. Code: Title 25, 2005, the Americans with Disabilities Act applies to all schools, dormitories, and other Indian education-related facilities operated by the Bureau, or under contract or grant with the Bureau. ADAABAAG Chapters 3–10 technical requirements, as referenced by ADA scoping Chapter 2, are to be applied.
- 2.3.4. Note:** There are minor differences between the ADA and ABA requirements. For example, ABAAS scoping section F206.1 does not allow exemptions to reduce employee work area clearances and routes with essential equipment or to eliminate handrails in work areas, as does ADA 206.1. Where conflicts occur between ABA and ADA scoping requirements, the more strict requirements shall apply.
- 2.3.5.** Dining surfaces, work surfaces and play areas for children’s use (ages 3–12) must meet ADAABAAG scoping and technical requirements. When children are primary users, USCA Title 29 § 794 promulgates ADAABAAG technical children anthropometrics to be applied to drinking fountains, water closets and toilet compartments, lavatories and sinks, and work surfaces, as well as elements that must be reached and/or operated, for example shower controls, elevator controls, dispensers, coat hooks, marker boards, etc. Water closet and reach ranges are subdivided into different children age groupings. ADAABAAG adult anthropometrics apply to students older than 12 years.
- 2.3.5.1.** Precise ages of children using spaces and rooms shall be clearly identified within designs and review submittals. Use by students not classified as “children” shall be identified by “older than 12 years.” Also, any elements and fixtures *not* to be used by students, regardless of age, shall be identified. Otherwise, an appropriate number of fully accessible elements for children and/or older students shall be provided in the design.
- 2.3.6.** When storage rooms are provided in an accessible room or space, at least one shall be arranged with wheelchair maneuvering clearances at both sides of the entry door, with wheelchair turning space within and, when elements such as closets, cabinets, shelves, clothes rods, hooks, and drawers are provided, at least one of each type shall comply with ADAABAAG reach range, clear floor space, and accessible hardware requirements.

- 2.3.7.** ADAABAAG 603.2.3 door swing exception No. 1, which allows a toilet room door to swing into the clear floor space or clearance required for any toilet room fixture, when the toilet room is accessed through a private office, SHALL NOT BE PERMITTED in new construction. All new toilet rooms, whether or not constructed fully accessible, shall be sized with wheelchair maneuvering clearances at both sides of the entry door, with wheelchair turning space within the toilet room, with the door not swinging into fixture space, and shall be arranged so future alterations, such as door swing reversal, will not need consideration.
- 2.3.8.** Five percent, but no fewer than one, of residential dwelling units, i.e., dormitory and apartment sleeping rooms, shall be arranged, as applicable, with adult or children's accessibility features, i.e., not all inclusive, accessible routes, moveable and fixed furniture and equipment, electrical switch and receptacle reach ranges, toilet and bathing facilities, and fire alarm visible strobe notification.
- 2.4. Building Safety Code.** All buildings, structures, and facilities shall be designed and constructed in accordance with the provisions of the current edition of NFPA 5000 Building Construction and Safety Code.
- 2.4.1. *Gymnasium Occupant Load for Egress.*** Calculate gymnasium occupant load using the appropriate occupant load factor for the highest probable occupant load. The occupant load factor shall be calculated at 1 person per 7 square feet of floor area with the bleachers retracted (concentrated use load), and shall also be calculated with the bleachers extended, allowing 18 lineal inches per occupant of bleacher seating and 7 square feet per occupant for the remainder of the gymnasium floor not covered by the extended bleacher seating. Means of egress and its components shall be designed in accordance with the National Fire Codes.
- 2.5. Boiler/Pressure Vessels.** The fabrication and installation of all new boiler and unfired pressure vessels shall conform to the American Society of Mechanical Engineers (ASME) Boiler and Pressure Vessel Code and shall be marked with appropriate ASME code symbols. The repair, alterations, or re-rating of all existing units shall conform to the National Board Inspection Code and shall be marked with appropriate code symbols. In each situation, the final product shall be inspected by an inspector holding a Certificate of Competency issued by an agency duly authorized by the National Board of Boiler and Pressure Vessel Inspectors.
- 2.6. Elevators.** All passenger and freight elevators, dumbwaiters, escalators, or moving sidewalks shall conform to ANSI/ASME A17.1 Safety Code for Elevators and Escalators.
- 2.7. Piping.** Boiler/pressure vessel external piping and piping installations shall conform to ANSI/ASME B31.1 Power Piping, and ASME Boiler and Pressure Vessel Code Section I – Power Boilers; Section IV – Heating Boilers; and Section VIII – Pressure Vessels – Division I. Other fuel piping, steam and water

pipng, air piping, and their respective installations shall conform to applicable sections of the Uniform Plumbing Code (UPC) and the Uniform Mechanical Code (UMC).

2.8. Mechanical Systems

- 2.8.1. **Liquefied Petroleum Gas.** Liquefied petroleum gas heating systems and distribution facilities shall conform to NFPA 58 Standard for the Storage and Handling of Liquefied Petroleum Gases and NFPA 86 Standard for Ovens and Furnaces.
- 2.8.2. **Natural Gas.** Natural gas systems shall comply with NFPA 54 National Fuel Gas Code and NFPA 86.
- 2.8.3. **Oil.** Oil-burning system installations shall conform to NFPA 31 Standard for the Installation of Oil-Burning Equipment and NFPA 86.
- 2.8.4. **Electrical.** Electrical heating and cooling systems shall be installed in accordance with the National Electrical Code (NFPA 70). Specific equipment shall be Underwriters Laboratory (UL) listed or labeled.
- 2.8.5. **Solar.** Solar installations shall be installed in accordance with the Uniform Solar Energy Code and with American Society of Heating, Refrigerating and Air-Conditioning Engineers (ASHRAE) standards.
- 2.8.6. **Cooling and Ventilation.** Cooling and ventilation systems shall conform to the Uniform Mechanical Code and NFPA 90A Standard for the Installation of Air-Conditioning and Ventilating Systems.

2.9. **Electrical Power Transmission.** Electrical power transmission, distribution, and installation shall comply with the National Electrical Code and the National Electrical Safety Code.

2.10. Environmental Quality

- 2.10.1. **Food Service.** All new construction, major alterations and improvements, minor remodeling, and operation of food service facilities shall conform to the guidelines set forth in the latest edition of the Public Health Service (PHS) *Food Service Sanitation Manual*.
- 2.10.2. **Sanitation Facilities.** All new construction, major alterations and improvements, and minor remodeling of sanitation facilities shall conform to the following guidelines:
 - 2.10.2.1. **Liquid Waste.** Applicable parts of 40 CFR, Protection of Environment, and 29 CFR 1910, Occupational Safety and Health Standards (OSHA).
 - 2.10.2.2. **Solid Waste.** Applicable parts of 40 CFR.
- 2.10.3. **Water Facilities.** All new construction, major alterations and improvements, and minor remodeling of domestic water facilities shall conform to 40 CFR and 29 CFR 1910 (OSHA).

2.10.4. *Illuminations.* All new construction, major alterations and improvements, and minor remodeling shall provide facilities that conform to the Illuminating Engineering Society's Standards and Regulations on Illumination, which include 29 CFR 1910 (OSHA).

2.10.5. *Heating, Ventilation, and Air-Conditioning (HVAC).* All new construction, major alterations and improvements, and minor remodeling of facilities shall conform to the minimum requirements given in the Uniform Mechanical Code, NFPA 90B Standard for the Installation of Warm Air Heating and Air-Conditioning Systems, and ASHRAE standards.

2.10.6. *Pest, Vector, and Vermin Control.* All new construction, major alterations and improvements, and minor remodeling shall provide facilities that conform to regulations on pest, vector, and vermin control included in 40 CFR, Parts 162, 163, 165, 170, and the provisions outlined in the PHS *Food Service Sanitation Manual* and *Institutional Sanitation Guidelines*.

2.11. Plumbing. All plumbing installations, equipment, and fixtures shall comply with the Uniform Plumbing Code.

2.11.1. *Plumbing Fixtures for Code Compliance.* The Uniform Plumbing Code specifies the minimum fixture requirements for water closets, urinals, drinking fountains, and lavatories. The number of fixtures required is determined using the occupant load of the building based upon minimum exiting requirements. Exiting requirements are found in NFPA 5000 Life Safety Code.

2.11.2. In NFPA 5000, ancillary spaces can be deducted when calculating certain requirements. Since one person (student or staff) cannot occupy two spaces simultaneously, it is understood that the square footage of ancillary spaces will not be counted when applying the provisions of the Uniform Plumbing Code.

2.11.3. Ancillary spaces in schools consist of the following, or similar, types of spaces:

- Agricultural/economic development classrooms
- Art, fine arts, or practical arts classrooms
- Band rooms
- Business classrooms
- Computer labs
- Computer-aided design classrooms
- Cultural classrooms
- Dining (cafeteria) rooms

- Driver's education classrooms
- Exceptional child classrooms
- Gifted and talented student classrooms
- Industrial arts, electrical, wood, metal, or automotive shops
- Language laboratories, including tribal language classrooms
- Library/media center
- Music or choral classrooms
- Occupational therapy/physical therapy (OT/PT) rooms
- Science laboratories, including biology, chemistry, physics, general science, and earth science
- Special education resource rooms
- Special programs classrooms
- Speech therapy rooms
- Student testing laboratories or rooms

2.11.4. Ancillary spaces in dormitories consist of the following, or similar, types of spaces:

- Counseling rooms
- Isolation health care sleeping rooms
- Practical arts rooms
- Student activity rooms
- Student living rooms
- Study rooms

2.11.5. In gymnasiums, the occupancy load, for purposes of determining plumbing fixture requirements, will be calculated at 15 net square feet per person plus bleacher seating capacity, including wheelchair spaces.

2.11.6. When calculating staff occupancy loads in classrooms, assume a teacher and an aid (two staff members) in each classroom.

2.12. Pipelines. Pipelines used to transport hazardous material, including natural and other gas and liquids, shall be designed, constructed, operated, maintained, tested, and repaired as required by 49 CFR, Transportation, Subchapter C, Hazardous Materials Regulations, Parts 172 and 173; and Subchapter D, Pipeline Safety, Parts 190, 191, 192, and 195.

1040-3. Unified Facilities Criteria

- 3.1.** For information on unique conditions not covered in this handbook, the Designer of Record shall consult the Unified Facilities Criteria (UFC).

THIS PAGE INTENTIONALLY LEFT BLANK

1050-1. Introduction

- 1.1. The Bureau of Indian Affairs is responsible for providing facilities to support educational programs for eligible Indian School Equalization Program (ISEP) students. The Bureau of Indian Education (BIE) develops educational space criteria and the Program of Requirements (POR) for each BIA school facility.
- 1.2. To ensure a quality educational environment for all students, the BIE seeks to create a standard method of evaluating space planning for all BIA schools. Their overall goal is to incorporate core instructional requirements with functional space needs, and to develop space standards for those needs that use existing national and state guidance.
- 1.3. The spaces identified in the *Educational Space Criteria Handbook* have been developed in the *BIA School Facilities Space Templates* and illustrate their spatial layout and programmatic needs in terms of architectural, interior design, structural, HVAC, electrical, communications, fire protection, and signage requirements.

THIS PAGE INTENTIONALLY LEFT BLANK

1060-1. Abbreviations

1.1. The following abbreviations for names and terms are used in this handbook.

AAMA	American Architectural Manufacturers Association
AASHTO	American Association of State Highway and Transportation Officials
ABA	Architectural Barriers Act
ABAAS	Architectural Barriers Act Accessibility Standard
ACI	American Concrete Institute
ADA	Americans with Disabilities Act
ADAABAAG	Americans with Disabilities Act and Architectural Barriers Act Accessibility Guidelines
AFF	above finished floor
AGA	American Gas Association
AHU	air handling unit
AIC	amps interrupting capacity
AISC	American Institute of Steel Construction
AISI	American Iron and Steel Institute
ANLA	American Nursery & Landscape Association (formerly the American Association of Nurserymen [AAN])
ANLA	American Standard for Nursery Stock (by the American Nursery & Landscape Association)
ANSI	American National Standards Institute
ARI	Air-Conditioning and Refrigeration Institute
ASCE	American Society of Civil Engineers
ASHRAE	American Society of Heating, Refrigerating and Air-Conditioning Engineers
ASME	American Society of Mechanical Engineers
ASSE	American Society of Sanitary Engineering
ASTM	American Society for Testing and Materials
ATC	Applied Technology Council

ATS	automatic transfer switch
A/V	audiovisual
AWI	Architectural Woodwork Institute
AWS	American Welding Society
AWWA	American Water Works Association
BHMA	Builders Hardware Manufacturers Association
BIA	Bureau of Indian Affairs
BIE	Bureau of Indian Education
BMP	best management practice
BOD ₅	biochemical oxygen demand (5-day)
BMS	building management system
CADD	Computer-Aided Design and Drafting
CFC	chlorofluorocarbon
CFR	Code of Federal Regulations
CGA	Compressed Gas Association
CMU	concrete masonry unit
CPSC	U.S. Consumer Product Safety Commission
CRI	color rendering index
CSI	Construction Specifications Institute
CT	current transformer
DCV	demand-controlled ventilation
DDC	direct digital control
DHW	domestic hot water
DIP	ductile iron pipe
DSRM	Division of Safety and Risk Management
DL	distance learning
DOE	U.S. Department of Energy
DX	direct expansion
EEPROM	electrically erasable programmable read-only memory

EPA	U.S. Environmental Protection Agency
EPROM	erasable programmable read-only memory
ESC	erosion and sedimentation control
ETS	environmental tobacco smoke
FACP	fire alarm control panel
FCC	Federal Communications Commission
FDC	fire department connection
FEMA	Federal Emergency Management Agency
FHWA	Federal Highway Administration
FIRM	Flood Insurance Rate Map
FM	Factory Mutual
FPE	fire protection engineer
FSC	Forest Stewardship Council
FSTC	field sound transmission class
GFCI	ground fault circuit interrupter
HCFC	hydrochlorofluorocarbon
H-O-A	hand-off-auto
HVAC	heating, ventilation, and air-conditioning
IAM	<i>Indian Affairs Manual</i>
IAMPO	International Association of Plumbing and Mechanical Officials
IAQ	indoor air quality
ICEA	Insulated Cable Engineers Association
IDF	intensity-duration-frequency
IEEE	Institute of Electrical and Electronics Engineers
IESNA	Illuminating Engineering Society of North America
IGSHPA	International Ground Source Heat Pump Association
IIC	impact insulation class
IMC	International Mechanical Code
IP	Internet Protocol

IPM	integrated pest management
IPMVP	International Performance Measurement & Verification Protocol
ISEP	Indian School Equalization Program
IT	information technology
KEE	ketone ethylene ester
LEED	Leadership in Energy and Environmental Design
LEED AP	LEED Accredited Professional
LEED-NC	Leadership in Energy and Environmental Design New Construction program
LPG	liquefied petroleum gas
LPI	Lightning Protection Institute
LTAR	long-term acceptance rate
M&V	measurement and verification
MBMA	Metal Building Manufacturers Association
MCC	motor control center
MDP	main distribution panel
MERV	Minimum Efficiency Reporting Value
MIC	microbiologically influenced corrosion
MSE	mechanically stabilized earth
NC	noise criterion
NEBB	National Environmental Balancing Bureau
NEC	National Electrical Code
NECA	National Electrical Contractors Association
NEMA	National Electrical Manufacturers Association
NETA	InterNational Electrical Testing Association
NFC	National Fire Code
NFPA	National Fire Protection Association
NGRS	National Geodetic Reference System
NIST	National Institute of Standards and Technology

NOAA	National Oceanic & Atmospheric Administration
NPDES	National Pollutant Discharge Elimination System
NPSH	net positive suction head
NPSI	National Playground Safety Institute
NPT	National Pipe Thread
NRC	noise reduction coefficient
NSF	National Sanitation Foundation
NSFPE	National Society of Fire Protection Engineers
O&M	operations and maintenance
OFMC	Office of Facilities Management and Construction
OIEP	Office of Indian Education Programs
OSB	oriented-strand board
OSHA	Occupational Safety & Health Administration
OSP	outside plant
PA	public address
PCB	polychlorinated biphenyl
PE	professional engineer
PHS	U.S. Public Health Service
PoE	Power over Ethernet
POR	Program of Requirements
PTZ	pan-tilt-zoom
PVC	polyvinyl chloride
QRAS	quick-response automatic sprinkler
RAM	random-access memory
RCDD	registered communications distribution designer
RCP	reinforced concrete pipe
RSES	Refrigeration Service Engineers Society
SDI	Steel Door Institute
SMACNA	Sheet Metal and Air Conditioning Contractors' National Association

SRI	solar reflectance index
SSPC	Society for Protective Coatings
STC	sound transmission class
SWMP	storm water management plan
SWPPP	storm water pollution prevention plan
TERO	Tribal Employment Rights Office
TGB	telecommunications grounding busbar
TLCP	Toxicity Characteristic Leaching Procedure
TMGB	telecommunications main grounding busbar
TPO	thermoplastic polyolefin
TR	telecommunications room
TVSS	transient voltage surge suppressor
UFC	Unified Facilities Criteria
UL	Underwriters Laboratories
UMC	Uniform Mechanical Code
UPC	Uniform Plumbing Code
UPS	uninterruptible power supply
USDA	United States Department of Agriculture
USDOT	United States Department of Transportation (USDOT)
USGBC	U.S. Green Building Council
VAV	variable air volume
VFD	variable frequency drive
VOC	volatile organic compound
WDMA	Window & Door Manufacturers Association
WPCF	Water Pollution Control Federation
WWPA	Western Wood Products Association

2000-1. Introduction

- 1.1. The *BIA School Facilities Design Handbook* establishes guidelines for design services and product deliverables. Following these guidelines will result in nationally uniform and predictable drawings sets, specifications, design materials, and services. Such consistency will greatly aid the review, approval, and coordination processes.
- 1.2. Unless specifically noted in the Statement of Work, all Designers of Record and consultants are to use these guidelines in the preparation of all project documents—drawings, specifications, or any other submittal data.
- 1.3. Any document prepared for submittal to the BIA must be clear, concise, and legible. All information must be clearly titled and dated. Packages must be properly numbered or indexed to allow for easy content navigation.

THIS PAGE INTENTIONALLY LEFT BLANK

2010-1. General

- 1.1. This section outlines the submittal requirements at each design stage and the responsibilities of the Designer of Record during each phase. Submittals are required at 20 percent completion (schematic design), 40 percent completion (design development), 70 percent completion (preliminary construction documents), 99 percent completion (completed construction documents), and 100 percent completion (final construction documents). Drawings in every submittal shall be as discussed in Section 2040, with the exception of design presentation boards. Specifications formatting is discussed in further detail in Section 2050.
- 1.2. **Written Comments.** After each review, the Designer of Record will be furnished written comments to be annotated and returned to the BIA. Comments shall be annotated as A=Concur, D=Do Not Concur, or E=Exception.
 - 1.2.1. Comments annotated with D or E shall be explained to justify noncompliance with the comment. Comments annotated with A may also be annotated with additional comments. These annotations will, in addition to explanations previously required, include a brief annotation for all comments concurred with as to what action was taken and where.
 - 1.2.2. The Designer of Record shall furnish all annotated comments to the BIA no later than 14 calendar days after receipt of all comments associated with the particular submittal.
 - 1.2.3. After each submittal, the Designer of Record shall make any corrections necessary. The Designer of Record shall not proceed or initiate any work on any successive design level prior to receipt of approval of the preceding design level.

2010-2. 20 Percent Completion – Schematic Design Submittal

- 2.1. **General.** The 20 percent completion schematic design submittal will comprise the documents necessary to illustrate the general scope, scale, arrangement, and relationships of project components. At this stage, the design will be conceptual. The content of the schematic design package shall include, but not be limited to, the following information:

20% Submittal Requirements – Schematic Design Phase				
General				
Item No.	Submittal Requirement	Yes	No	N/A
1	Update any previous schedule for milestones, submittals, contracting, and construction.			
2	Develop probable costs based on the schematic design information. In the event the project cost estimate exceeds the established budget, the Designer of Record shall make recommendations and notify, in writing, the Contracting Officer for further direction.			
3	Coordinate LEED documentation for 20% schematic design, illustrating proposed strategies for compliance with LEED requirements and ways to achieve certification goals.			

20% Submittal Requirements – Schematic Design Phase				
Civil				
Item No.	Submittal Requirement	Yes	No	N/A
1	Communicate conceptual design solutions and alternatives in the civil narrative and drawings.			
2	Include graphic design of schematic land use.			
3	Show physical influences.			
4	Show property lines, north arrow, and scale.			
5	Show site access points.			
6	Show existing natural features.			
7	Show proposed roads and parking.			
8	Provide recommendations for controlling runoff.			
9	Show existing water and sanitation facilities with respective appurtenances indicated.			
10	Provide a detailed outline of proposed water and sanitation facilities, indicating point of connection to existing systems.			
11	Indicate all necessary valves, fire hydrants, ground storage tanks, pump stations, etc.			
12	Submit a chemical analysis of the water supply.			
13	Indicate all necessary treatment plants, manholes, lift stations, force mains, septic tanks, grease traps, oil/water separators, etc.			
14	Provide preliminary opinion of estimated cost.			
15	Provide a site survey.			
16	Provide a geotechnical report (if not provided with preliminary plan).			

20% Submittal Requirements – Schematic Design Phase				
Landscape				
Item No.	Submittal Requirement	Yes	No	N/A
1	Communicate conceptual design solutions and alternatives in the landscape narrative and drawings.			
2	Develop conceptual design solutions for land forms, lawns, and plantings based on program requirements, physical site characteristics, design objectives, and environmental determinates.			
3	Provide a conceptual layout of outdoor recreational areas, including fields, lawns, play pads, etc.			

20% Submittal Requirements – Schematic Design Phase				
Architectural				
Item No.	Submittal Requirement	Yes	No	N/A
1	Communicate conceptual design solutions and alternatives in the architectural narrative and drawings.			
2	Provide conceptual site plan and building plans, including room numbers and areas.			
3	Include an approximate footprint, areas, and volumes that meet the POR and adjacency requirements.			
4	Provide building shading and solar control analysis.			
5	Provide preliminary building sections and elevations.			
6	Provide a preliminary selection of building systems and materials.			
7	Provide perspective sketches and/or study models (electronic and/or physical) as required to describe the design.			
8	Coordinate architectural work with that of engineering and other design disciplines involved in the project.			
9	Review and check documents prepared for the project.			

20% Submittal Requirements – Schematic Design Phase				
Structural				
Item No.	Submittal Requirement	Yes	No	N/A
1	Communicate conceptual design solutions and alternatives in the structural narrative and drawings.			
2	Include structural design criteria.			

20% Submittal Requirements – Schematic Design Phase				
Mechanical/Fire Protection				
Item No.	Submittal Requirement	Yes	No	N/A
1	Communicate conceptual design solutions and alternatives in the mechanical narrative and drawings, including: <ul style="list-style-type: none"> • Scope of project • Preliminary systems selections <ul style="list-style-type: none"> - HVAC, controls/EMS, plumbing, and fire protection • Energy sources • Utility availability/capacities • Established building energy budget 			
2	Provide design analysis, including: <ul style="list-style-type: none"> • Building preliminary energy modeling • Matrix of LCCA options <ul style="list-style-type: none"> - including solar hot water • Supporting data/calculations • Fire protection design analysis 			
3	<ul style="list-style-type: none"> • Review LEED requirements and provide strategies for compliance 			

20% Submittal Requirements – Schematic Design Phase				
Electrical				
Item No.	Submittal Requirement	Yes	No	N/A
1	Communicate conceptual design solutions and alternatives in the electrical narrative and drawings.			
2	Coordinate with utility company and provide available power characteristics.			
3	Provide generator recommendation.			
4	Provide lightning protection recommendation.			
5	Provide renewable energy source recommendation.			
6	Indicate lighting power density.			
7	Include a legend.			
8	Provide power plans, including: <ul style="list-style-type: none"> • Typical room layouts • Major equipment locations 			
9	Provide lighting plans, including: <ul style="list-style-type: none"> • Typical room layouts • Typical room point-by-point foot-candle calculations 			

10	Provide a one-line diagram, including: <ul style="list-style-type: none"> • System voltage and phase • Preliminary equipment sizes • Conduit and wire sizing is not required 			
11	Provide sample schedules, including: <ul style="list-style-type: none"> • Panel schedule • Switchboard • Motor control center • Feeder schedule • Mechanical schedule • Luminaire schedule • Transformer schedule • Kitchen equipment schedule 			

20% Submittal Requirements – Schematic Design Phase

Information Technology

Item No.	Submittal Requirement	Yes	No	N/A
1	Communicate conceptual design solutions and alternatives for the IT systems in IT narrative and drawings. The narrative should also include the application of the IT Systems Selection Matrix used to determine the systems to be included.			
2	Provide generalized plan views of a typical telecommunications room, entrance facility, classroom, and office, along with any other appropriate major spaces. These may either be inserted within the narrative or included as separate drawings.			
3	Indicate general space requirements and locations for major IT components.			

2010-3. 40 Percent Completion – Design Development Submittal

- 3.1. General.** Based upon the approved schematic design, design development documents are refinements of the project design. In the design development phase, the Designer of Record will establish the scope, relationships, forms, size, and appearance of the project. The design development package shall constitute a 40 percent construction documents level of detail. Plans, sections, elevations, typical construction details, and system and equipment layouts are included in this phase. Major materials and systems will be identified in the specifications, and minimum quality standards will be established. The content of the design development package shall include, but not be limited to, the following information:

40% Submittal Requirements – Design Development Phase				
General				
Item No.	Submittal Requirement	Yes	No	N/A
1	Update the previous schedule for milestones, submittals, contracting, and construction.			
2	Develop probable costs based upon the design development information. Cost estimates are to be presented by division and section according to CSI <i>MasterFormat</i> . In the event the project cost estimate exceeds the established budget, the Designer of Record shall make recommendations and, during the preliminary construction documents phase, make any changes necessary to bring the project within budget.			
3	For projects over \$1 million, a value engineering study is required. The Designer of Record shall assist the BIA with the value engineering effort. This effort will include the evaluation of value engineering recommendations for review by the BIA. The Designer of Record shall incorporate approved value engineering changes during the 70% preliminary construction documents phase.			
4	Coordinate LEED documentation for 40% design development, indicating proposed strategies for compliance with LEED requirements and ways to achieve certification goals.			
5	The Designer of Record shall annotate the review comments in the development of data for the next design level. If any review comment requires clarification and/or amplification to assure understanding, the Designer of Record shall notify the Contracting Officer in writing.			
6	Incorporate all approved comments from the BIA review of the 20% schematic design submittal.			

40% Submittal Requirements – Design Development Phase				
Civil				
Item No.	Submittal Requirement	Yes	No	N/A
1	Include design development level completion of all previous 20% submittal requirements, including an updated design narrative.			
2	Provide basic site design.			
3	Describe project location, as well as factors and objectives influencing the site plan.			
4	Show existing site features, including topography, acreage, boundaries, benchmark (B.M.) datum, etc.			
5	Indicate requirements for flood protection.			
6	Indicate items requiring removal/relocation.			
7	Indicate site geometry, including setback or clearance requirements.			
8	Indicate erosion control measures implemented.			
9	Provide storm management plan with USGBC designs implemented to the fullest extent possible.			
10	Indicate easement requirements.			
11	Indicate existing site features such as buildings, streets, curbs, walks, fences, planted areas, site screens, plazas, courtyards, fountains, watercourses, ponds, elevation of high water, rock outcrops, etc.			
12	Indicate planned finished floor elevations and critical spot elevations.			
13	Indicate preliminary design analysis and calculations for site earthwork (cut or fill requirements and rough estimate of quantities) and drainage control.			
14	Indicate complete drainage concept using either finished contours or slope arrows, and estimate storm drain pipe sizes.			
15	Indicate existing utilities within the topography; show removals, relocations, and new work for utilities on separate plans; indicate critical depths and overhead clearances. (Utilities include gas, electric, drainage lines, etc.)			
16	Show schematic layout of wastewater and water collection and treatment systems, indicating invert elevations of all new and existing sanitary sewer and waterlines and top and invert elevations of all new and existing manholes.			
17	Indicate existing soil conditions affecting design.			
18	Indicate design values for flexible and rigid pavements.			

19	Indicate road design including all dimensions, slopes, and paralleling structures (curbs, sidewalks, guardrails, traffic signs, markings, fencing, etc.).			
20	Indicate parking and open storage areas, number, sizes, locations, access, etc.			
21	Indicate new work and connections to existing distribution system on water and sanitary site plans.			
22	Include details to obtain adequate cost estimates for items such as lift stations, septic tanks, oil separators, etc.			
23	Update to 40% design development phase cost estimate.			
24	Provide outline or draft specifications.			
25	Provide detailed calculations and criteria for the items listed above.			
26	Review comments and provide responses.			

40% Submittal Requirements – Design Development Phase

Landscape

Item No.	Submittal Requirement	Yes	No	N/A
1	Include design development level completion of all previous 20% submittal requirements, including an updated design narrative. Additional submittal requirements include the following:			
2	Preliminary landscape plan			
3	Preliminary irrigation plan			
4	Typical landscape details			
5	Outline or draft specifications			

40% Submittal Requirements – Design Development Phase				
Architectural				
Item No.	Submittal Requirement	Yes	No	N/A
1	Include design development level completion of all previous 20% submittal requirements, including an updated design narrative. Additional submittal requirements include the following:			
2	Plans, including code plans, floor plans, roof plans, and reflected ceiling plans. Code plans shall include areas for each space. Plans shall include major dimensions.			
3	Building sections and elevations			
4	Critical interior elevations			
5	Typical details and wall sections			
6	Typical casework elevations			
7	Final materials selections			
8	Equipment layouts			
9	Furniture, furnishings, and equipment selections			
10	Typical interior details of construction			
11	Perspective sketches and/or study models (electronic or physical) as required to describe the design			
12	Outline or draft specifications			

40% Submittal Requirements – Design Development Phase				
Structural				
Item No.	Submittal Requirement	Yes	No	N/A
1	Include design development level completion of all previous 20% submittal requirements, including an updated design narrative. Additional submittal requirements include the following:			
2	Final structural design criteria			
3	Structural foundation plan identifying the foundation system and defining representative sizes and depths			
4	Structural floor framing plan identifying the floor framing system and lateral system with representative member sizes			
5	Structural roof framing plan identifying the roof framing system and lateral system with representative member sizes			
6	Representative details defining critical dimensions of the structure			
7	Outline or draft specifications			

40% Submittal Requirements – Design Development Phase				
Mechanical/Fire Protection				
Item No.	Submittal Requirement	Yes	No	N/A
1	Include design development level completion of all previous 20% submittal requirements, including an updated design narrative. Additional submittal requirements include the following:			
2	Finalized design analysis, including: <ul style="list-style-type: none"> • Recommended LCCA items 			
3	Mechanical and plumbing legends (separate drawings)			
4	Preliminary mechanical schedules			
5	Outline or draft specifications			
6	Full-building HVAC plans illustrating: <ul style="list-style-type: none"> • Equipment locations • Initial mechanical room layouts • One-line of ductwork layout • One-line of main piping layout • Piping/HVAC flow diagrams 			
7	Full-building plumbing plans illustrating: <ul style="list-style-type: none"> • Water and sewer entrances • One-line of roof drainage • One-line of main plumbing lines • Initial riser diagrams 			
8	Temperature controls/EMS design, including: <ul style="list-style-type: none"> • Control diagrams • I/O list in outline specification • Sequence of operation in outline specification • Temperature control zone plan 			
9	Fire protection design, including: <ul style="list-style-type: none"> • Draft performance specification • Plan for location of utility interface, fire protection header, etc. • Flow test results 			

10	Preliminary calculations, including: <ul style="list-style-type: none"> • Heating and cooling load • Utility pipe sizing • Plumbing fixture count • Pipe stress (preliminary) • Acoustical evaluation (preliminary) • Friction calculations – air/liquid (preliminary) • Other 			
11	Makeup water test analysis results, including: <ul style="list-style-type: none"> • Water treatment recommendations 			
12	Review of design for compliance with LEED requirements: <ul style="list-style-type: none"> • Energy budget met • No CFCS or HCFCs • Early involvement of Commissioning Agent • Zone control strategies achieved • Other 			

40% Submittal Requirements – Design Development Phase				
Electrical				
Item No.	Submittal Requirement	Yes	No	N/A
1	Include design development level completion of all previous 20% submittal requirements, including an updated design narrative. Additional submittal requirements include the following:			
2	Site plans illustrating: <ul style="list-style-type: none"> • Utility company coordination • Utility transformer location • Feeder routing, overhead vs. underground • All exterior light fixture locations 			
3	Renewable energy source location			
4	Full-building power plans illustrating: <ul style="list-style-type: none"> • Panel, switchgear, and transformer locations • Receptacle locations 			
5	Full-building lighting plans illustrating: <ul style="list-style-type: none"> • All interior fixture locations • Fixture designations • Specialty area point-by-point foot-candle calculations • Exterior point-by-point foot-candle calculations 			
6	Fire alarm plans illustrating: <ul style="list-style-type: none"> • Device locations 			
7	One-line diagram illustrating: <ul style="list-style-type: none"> • Preliminary load calculations 			
8	Luminaire schedule			
9	Outline or draft specifications			

40% Submittal Requirements – Design Development Phase				
Information Technology				
Item No.	Submittal Requirement	Yes	No	N/A
1	Include design development level completion of all previous 20% submittal requirements, including an updated design narrative. Additional submittal requirements include the following:			
2	Outline or draft specifications			
3	Preliminary drawings, including but not limited to: <ul style="list-style-type: none"> • Title sheet with IT-specific symbols • Site plan • Riser diagram for communications cabling systems • Riser diagram for pathway/raceway/sleeves • One-line diagrams for all applicable systems • Scaled floor plans showing device locations • Enlarged communication rooms (and other IT spaces as required) 			
4	Drawings complete with notes developed to a preliminary level			

2010-4. 70 Percent Completion – Preliminary Construction Documents Submittal

- 4.1. General.** In the 70 percent preliminary construction documents phase, the Designer of Record refines the approved design development information to establish the requirements for the construction of the work. The 70 percent construction documents will include near-complete drawings and specifications to establish in detail the quality levels and construction of building materials, components, and systems. The content of the 70 percent construction documents package shall include, but not be limited to, the following information:

70% Submittal Requirements – Preliminary Construction Documents Phase				
General				
Item No.	Submittal Requirement	Yes	No	N/A
1	Update the previous schedule for milestones, submittals, contracting, and construction.			
2	Develop probable costs based upon the preliminary construction documents information. Cost estimates are to be presented by division and section according to <i>CSI MasterFormat</i> . In the event the estimated project cost exceeds the established budget, the Designer of Record shall make recommendations necessary to bring the project within budget and notify the Contracting Officer, in writing, before proceeding.			
3	Coordinate LEED documentation for 70% preliminary construction documents, indicating proposed strategies for compliance with LEED requirements and ways to achieve certification goals.			
4	Incorporate all approved comments from the BIA review of the 40% design development submittal.			

70% Submittal Requirements – Preliminary Construction Documents Phase				
Civil				
Item No.	Submittal Requirement	Yes	No	N/A
1	Include preliminary construction document level completion of all previous 40% submittal requirements with the exception of an updated design narrative.			
2	Integrate the approved site development and data into working drawings.			
3	Provide location and vicinity maps.			
4	Develop detail sheets with proper references.			
5	Complete geometric layout of all items of new work using offset dimensions from existing structures, or use coordinates for locating new work.			

6	Develop new site grading, street plan, and profile with proper drainage, and include information of specific items of work, soil boring locations, and designations, coordinated with test hole locations and logs.			
7	Complete the legend using all items and symbols shown on the plan, maintaining consistency between drawings.			
8	Indicate limits of construction disturbance, and provide narrative delineating areas to be restored.			
9	Provide an erosion control plan, including control objectives comparing post- and pre-development conditions.			
10	Describe temporary and permanent erosion and storm water control measures.			
11	Describe type and frequency of required maintenance activities for erosion control facilities.			
12	Provide complete storm drainage design calculations consistent with previous design submittals.			
13	Provide a map outlining drainage areas.			
14	Provide calculations for sizing retention and/or detention ponds.			
15	Provide watertight joints for drainage pipe under all pavements when the pipe is in non-cohesive soil.			
16	Complete and present flexible and rigid pavement design calculations.			
17	Describe nature of paving materials and provide typical pavement sections, as well as minimum compaction requirements.			
18	Include all items of work superimposed on the existing topography, and establish a base control system for locations (buildings, streets, walks, etc.).			
19	Indicate proposed contours for new grading and provide spot elevations as required to facilitate site layout.			
20	Lay out storm drainage using symbols per legend; identify drainage structures; provide profiles for all storm drains and culverts.			
21	Indicate top and flowline elevations of all drainage structures, size and invert elevations for storm pipe, ground profile, and new or existing utility crossings.			
22	Locate monuments and benchmarks for horizontal and vertical control.			
23	Indicate finished floor elevations of the new buildings.			
24	Show on the plan the construction centerline, right-of-way limits, and all important topographical features such as fences, buildings, streams, railroads, etc.			

25	Provide complete survey information necessary for establishment of the survey centerline, including pertinent bearings.			
26	Profiles shall provide elevations at points where changes of grade occur, as well as stationing elevations.			
27	Include typical sections through the site as required for clarity, as well as a legend.			
28	Include concrete joint details, layout, and sidewalk joints.			
29	Include storm drainage pipe and structure schedule.			
30	Include parking layout.			
31	Include roadway widening details and super-elevation information.			
32	Provide detailed floor plans and sections of treatment plants and pumping stations, with equipment layout, piping, and sufficient dimensions and elevations to physically locate all items of equipment, piping, etc.			
33	Provide instrumentation and control schematics for pertinent machine systems, as well as equipment size, horsepower rating, and sequences of operation.			
34	Provide a site plan showing all existing and new valves, fire hydrants, manholes, pumping stations, laterals, meters, etc.			
35	Indicate all sizes of waterlines, sanitary sewers, and force mains.			
36	Provide invert and rim elevations for all manholes.			
37	Provide profiles of gravity sewers, and existing sewer line crossings; double lines are required for profile piping.			
38	Provide details for connecting new lines to existing systems.			
39	Provide profiles for water distribution and supply lines where crossings of other new or existing utilities occur.			
40	Provide layout of solid waste disposal system equipment and mode of operation.			
41	Provide plan of irrigation and/or sprinkler system, with flow requirements for each area.			
42	Provide complete specifications.			
43	Provide detailed calculations/criteria for items listed above.			

70% Submittal Requirements – Preliminary Construction Documents Phase				
Landscape				
Item No.	Submittal Requirement	Yes	No	N/A
1	Include preliminary construction document level completion of all previous 40% submittal requirements with the exception of an updated design narrative. Additional submittal requirements include the following:			
2	Planting legend and details			
3	Landscape plan illustrating all plant types, quantities, locations, size and condition			
4	Site amenities plan			
5	Site layout plan			
6	Landscape details			
7	Irrigation plan			
8	Irrigation details			
9	Site details			
10	Complete specifications for landscape and irrigation systems			

70% Submittal Requirements – Preliminary Construction Documents Phase				
Architectural				
Item No.	Submittal Requirement	Yes	No	N/A
1	Include preliminary construction document level completion of all previous 40% submittal requirements with the exception of an updated design narrative. Additional submittal requirements include the following:			
2	Floor plans indicating door swings, room names, general dimensions, location and identification of equipment, etc., coordinated with engineering disciplines			
3	Enlarged plans for detailed areas, including toilet rooms, mechanical rooms, etc.			
4	Stair and elevator core plans and sections			
5	Reflected ceiling plans indicating ceiling heights, finishes, and coordination with engineering disciplines			
6	Building sections as necessary indicating vertical dimensions, construction systems, and coordination with engineering disciplines			
7	Exterior building elevations indicating building dimensions, materials, and coordination with engineering disciplines			

8	Typical details and wall sections indicating materials, major features including beams, joists, foundations, etc., and illustrating bearing heights, finished floor elevations, etc.			
9	Finish plan and schedule			
10	Door and window elevations and schedule			
11	Casework elevations			
12	Equipment layouts			
13	Kitchen equipment plans and details			
14	Furniture, furnishings, and equipment selections			
15	Interior construction details			
16	Complete specifications of all materials and systems			

70% Submittal Requirements – Preliminary Construction Documents Phase

Structural

Item No.	Submittal Requirement	Yes	No	N/A
1	Include preliminary construction document level completion of all previous 40% submittal requirements with the exception of an updated design narrative. Additional submittal requirements include the following:			
2	Design criteria and general notes on the drawings			
3	Structural foundation plan showing all foundation elements			
4	Structural floor framing plan showing all floor framing members and sizes			
5	Structural roof framing plan showing all roof framing members.			
6	Complete structural specifications			

70% Submittal Requirements – Preliminary Construction Documents Phase

Mechanical/Fire Protection

Item No.	Submittal Requirement	Yes	No	N/A
1	Include preliminary construction document level completion of all previous 40% submittal requirements with the exception of an updated design narrative. Additional submittal requirements include the following:			
2	Updated mechanical/plumbing legends			
3	Updated mechanical schedules			
4	Complete mechanical specifications			

5	HVAC plans, sections, and details, including: <ul style="list-style-type: none"> • Enlarged mechanical plans • Details of pumps, coils, chiller, boiler, AHU, etc. • Location and sizes of all equipment/systems • Two-lined ductwork • Sections of kitchen, multi-purpose, shops, and mechanical rooms 			
6	Plumbing plans, including: <ul style="list-style-type: none"> • Roof drainage • Waste/vent/water plumbing • Restroom and kitchen riser diagrams • Enlarge bathrooms and kitchens 			
7	Temperature controls/EMS design, including: <ul style="list-style-type: none"> • Updated control drawings • Location plans for sensors/control devices and controllers • Updated I/O list and sequence of control in specification 			
8	Fire protection design, including: <ul style="list-style-type: none"> • Updated performance specifications and equipment location drawings 			
9	Updated calculations, including: <ul style="list-style-type: none"> • All systems • Seismic, acoustics, and piping stress calculations (as required) • Final building energy modeling 			
10	Review of design for compliance with LEED requirements: <ul style="list-style-type: none"> • Review final LEED score card with team 			

70% Submittal Requirements – Preliminary Construction Documents Phase

Electrical

Item No.	Submittal Requirement	Yes	No	N/A
1	Include preliminary construction document level completion of all previous 40% submittal requirements with the exception of an updated design narrative. Additional submittal requirements include the following:			
2	Site plan: <ul style="list-style-type: none"> • Utility meter and CT locations • Duct bank locations and details • Cathodic protection • Lighting circuiting 			

3	Renewable energy source: <ul style="list-style-type: none"> • Size and characteristics • Utility company coordination 			
4	Power plans: <ul style="list-style-type: none"> • Device circuiting • Mechanical equipment locations • Special system equipment locations • Correct physical sizing of panelboards, switchgear, transformers, etc., shown on the plans 			
5	Lighting plans: <ul style="list-style-type: none"> • Fixture circuiting • Lighting controls 			
6	Fire alarm plans: <ul style="list-style-type: none"> • Fire protection requirements 			
7	One-line diagram: <ul style="list-style-type: none"> • Wire and conduit size 			
8	Electrical details			
9	Schedules: <ul style="list-style-type: none"> • Panel • Mechanical • Kitchen 			
10	Specifications <ul style="list-style-type: none"> • Updated edit 			
11	Review of design for compliance with LEED requirements			

70% Submittal Requirements – Preliminary Construction Documents Phase

Information Technology

Item No.	Submittal Requirement	Yes	No	N/A
1	Include preliminary construction document level completion of all previous 40% submittal requirements with the exception of an updated design narrative. Additional submittal requirements include the following:			
2	Preliminary specifications			
3	Drawings developed to a near-final level, setting forth in detail the IT construction requirements, including equipment layout and routing.			
4	Wall and equipment rack elevations added to the enlarged communications room(s) drawings			
5	Detail drawings developed to a preliminary level			
6	Drawings complete with notes developed to a near-final level			

2010-5. 99 Percent Completion – Completed Construction Documents Submittal

- 5.1. General.** In the 99% completed construction documents phase, the Designer of Record refines the approved preliminary construction documents information to establish the completed requirements for the construction of the work. The completed construction documents will include all drawings and specifications to establish in detail the quality levels and construction of building materials, components, and systems. The content of the 99% completed construction documents package shall include, but not be limited to, the following information:

99% Submittal Requirements – Completed Construction Documents Phase				
General				
Item No.	Submittal Requirement	Yes	No	N/A
1	Update the previous schedule for milestones, submittals, contracting, and construction.			
2	Develop probable costs based on the completed construction documents. Cost estimates are to be presented in CSI format.			
3	Coordinate LEED documentation for 99% completed construction documents, including fully documented strategies for compliance with LEED requirements and ways to achieve certification goals.			
4	Incorporate all approved comments from the BIA review of the 70% preliminary construction documents submittal.			

99% Submittal Requirements – Completed Construction Documents Phase				
Civil				
Item No.	Submittal Requirement	Yes	No	N/A
1	Include completed construction document level development of all previous 70% submittal requirements.			
2	Provide complete civil and site drawings.			
3	Show refined grades, dimensions, complete legends, specific and general notes, north arrows, etc.			
4	Ensure correct cross-referencing among site drawings for appropriate details, sections, match lines, etc.			
5	Eliminate all conflicts (horizontal and vertical) among site plans and architectural, structural, and utilities plans.			
6	Verify that terminology is consistent between plans and specifications for notations on specific items of work.			
7	Perform check for adequate referencing of construction details.			
8	Complete storm, water, and sanitary sewer drawings.			
9	Provide final erosion control plan (complete).			

10	Provide final drainage report and plan.			
12	Provide final civil construction specifications.			
12	Provide final detailed calculations/criteria for the items listed above.			

99% Submittal Requirements – Completed Construction Documents Phase

Landscape

Item No.	Submittal Requirement	Yes	No	N/A
1	Include completed construction document level development of all previous 70% submittal requirements. Additional submittal requirements include the following:			
2	Completed planting legend and details			
3	Completed landscape plan illustrating all plant types, quantities, locations, size, and condition			
4	Completed site amenities plan			
5	Completed site layout plan			
6	Completed landscape details			
7	Completed irrigation plan			
8	Completed irrigation details			
9	Completed site details			
10	Complete specifications for landscape and irrigation systems			

99% Submittal Requirements – Completed Construction Documents Phase

Architectural

Item No.	Submittal Requirement	Yes	No	N/A
1	Include completed construction document level development of all previous 70% submittal requirements. Additional submittal requirements include the following:			
2	Completed floor plans indicating door swings, room names, general dimensions, location and identification of equipment, etc., coordinated with engineering disciplines			
3	Completed enlarged plans for detailed areas, including toilet rooms, mechanical rooms, etc.			
4	Completed stair and elevator core plans and sections			
5	Completed reflected ceiling plans indicating ceiling heights, finishes, and coordination with engineering disciplines			
6	Completed building sections as necessary indicating vertical dimensions, construction systems, and coordination with engineering disciplines			

7	Completed exterior building elevations indicating building dimensions, materials, and coordination with engineering disciplines			
8	Completed details and wall sections as required to clearly delineate the construction requirements			
9	Completed finish plan and schedule			
10	Completed door and window elevations and schedule			
11	Completed casework elevations			
12	Completed equipment layouts			
13	Completed kitchen equipment plan and details			
14	Furniture, furnishings, and equipment selections			
15	Interior details of construction			
16	Final construction specifications of all materials and systems			

99% Submittal Requirements – Completed Construction Documents Phase

Structural

Item No.	Submittal Requirement	Yes	No	N/A
1	Include completed construction document level development of all previous 70% submittal requirements. Additional submittal requirements include the following:			
2	Geotechnical certification letter			
3	Final structural construction specifications			

99% Submittal Requirements – Completed Construction Documents Phase

Mechanical/Fire Protection

Item No.	Submittal Requirement	Yes	No	N/A
1	Include completed construction document level development of all previous 70% submittal requirements. Additional submittal requirements include the following:			
2	Final mechanical/plumbing legends			
3	Final mechanical schedules			
4	Final mechanical specifications			
5	Final HVAC plans, sections, and details			
6	Final plumbing plans			
7	Final temperature control/EMS drawing			
8	Final mechanical construction specifications			
9	Final fire protection performance specification and drawings			
10	Final calculations			

99% Submittal Requirements – Completed Construction Documents Phase				
Electrical				
Item No.	Submittal Requirement	Yes	No	N/A
1	Include completed construction document level development of all previous 70% submittal requirements. Additional submittal requirements include the following:			
2	Site plan: <ul style="list-style-type: none"> • Final plan 			
3	Renewable energy source: <ul style="list-style-type: none"> • Final design • Tie to power distribution 			
4	Power plans: <ul style="list-style-type: none"> • Final plans 			
5	Lighting plans: <ul style="list-style-type: none"> • Final plans 			
6	Fire alarm plans: <ul style="list-style-type: none"> • Final plans • Coordination with mechanical equipment 			
7	One-line diagram: <ul style="list-style-type: none"> • Final plans • Final load calculations • Short-circuit ratings • Coordination of breaker settings 			
8	Final electrical construction specifications			

99% Submittal Requirements – Completed Construction Documents Phase				
Information Technology				
Item No.	Submittal Requirement	Yes	No	N/A
1	Include completed construction document level development of all previous 70% submittal requirements. Additional submittal requirements include the following:			
2	Final IT construction specifications			
3	Final drawings setting forth in detail the IT construction requirements			

2010-6. 100 Percent Completion – Final Construction Documents Submittal

- 6.1. General.** In the 100 percent final construction documents phase, the Designer of Record finalizes the construction documents information to establish the completed requirements for the construction of the work, including incorporation of all accepted review comments. The final construction documents shall include all drawings and specifications to establish in detail the quality levels and construction of building materials, components, and systems. The content of the 100 percent final construction documents package shall include, but not be limited to, the following information:

100% Submittal Requirements – Final Construction Documents Phase				
General				
Item No.	Submittal Requirement	Yes	No	N/A
1	Update the previous schedule for milestones, submittals, contracting, and construction.			
2	Incorporate all approved comments from the BIA review of the 99% completed construction documents submittal.			
3	Coordinate LEED documentation for 100% final construction documents, including fully documented strategies for compliance with LEED requirements and ways to achieve certification goals.			

100% Submittal Requirements – Final Construction Documents Phase				
Civil				
Item No.	Submittal Requirement	Yes	No	N/A
1	Include all requirements of the 99% submittal plus the following:			
2	Final specifications revised to reflect final review comments			
3	Drawings revised to reflect final review comments			

100% Submittal Requirements – Final Construction Documents Phase				
Landscape				
Item No.	Submittal Requirement	Yes	No	N/A
1	Include all requirements of the 99% submittal plus the following:			
2	Final specifications revised to reflect final review comments			
3	Drawings revised to reflect final review comments			

100% Submittal Requirements – Final Construction Documents Phase				
Architectural				
Item No.	Submittal Requirement	Yes	No	N/A
1	Include all requirements of the 99% submittal plus the following:			
2	Final specifications revised to reflect final review comments			
3	Drawings revised to reflect final review comments			

100% Submittal Requirements – Final Construction Documents Phase				
Structural				
Item No.	Submittal Requirement	Yes	No	N/A
1	Include all requirements of the 99% submittal plus the following:			
2	Final specifications revised to reflect final review comments			
3	Drawings revised to reflect final review comments			
4	Final structural calculations			

100% Submittal Requirements – Final Construction Documents Phase				
Mechanical/Fire Protection				
Item No.	Submittal Requirement	Yes	No	N/A
1	Include all requirements of the 99% submittal plus the following:			
2	Final specifications revised to reflect final review comments			
3	Drawings revised to reflect final review comments			

100% Submittal Requirements – Final Construction Documents Phase				
Electrical				
Item No.	Submittal Requirement	Yes	No	N/A
1	Include all requirements of the 99% submittal plus the following:			
2	Final specifications revised to reflect final review comments			
3	Drawings revised to reflect final review comments			

100% Submittal Requirements – Final Construction Documents Phase				
Information Technology				
Item No.	Submittal Requirement	Yes	No	N/A
1	Include all requirements of the 99% submittal plus the following:			
2	Final specifications revised to reflect final review comments			
3	Drawings revised to reflect final review comments			

2010-7. Construction Procurement Services

7.1. The Designer of Record shall, following approval of the final construction documents, assist the BIA in obtaining bids or negotiated proposals and in awarding construction contracts. The responsibilities of the Designer of Record for construction procurement services shall include, but not be limited to, the following:

- Assist the BIA in the evaluation and validation of bids
- If requested by the BIA, arrange for reproduction and distribution of bidding documents to prospective bidders
- Maintain logs of bidding documents distributions, retrievals, and deposits
- Assist the BIA in considering substitution requests
- Provide clarifications and interpretations to questions from prospective bidders and prepare and distribute addenda
- Participate in a pre-bid conference for prospective bidders
- If requested by the BIA, participate in selection interviews with prospective contractors
- If requested by the BIA, participate in negotiations with prospective contractors

THIS PAGE INTENTIONALLY LEFT BLANK

2020-1. General

- 1.1. It is expected that all design work produced under these guidelines will be without deficiencies, so that no modifications or corrections need be issued and so contractors are able to complete the project satisfactorily working from the final construction documents. To this end, it is the Designer of Record's responsibility to coordinate their own work and the work of their consultants in preparing all drawings and specifications. All documents must be fully reviewed prior to their release at any stage to ensure that they are adequately detailed, properly cross-referenced, complete, free of omissions and repetition, and contain no unresolved conflicts. Accurate drawing information and specifications are paramount in avoiding construction delays, additional costs, and errors.

2020-2. Owner-Provided Data

- 2.1. Owner-provided information and data must be well coordinated and incorporated into the appropriate documents. Data or recommendations from consultants working directly for the BIA are to be integrated into the design to the extent directed by the BIA.

2020-3. Commissioning Agent

- 3.1. The Designer of Record is required to coordinate and communicate with a third-party Commissioning Agent. The Commissioning Agent will be contracted directly to the owner. The Designer of Record must provide one set of documents at each required submittal to the Commissioning Agent for their concurrent review. With the owner's approval, the Designer of Record shall incorporate the Commissioning Agent's comments into the project.

THIS PAGE INTENTIONALLY LEFT BLANK

2030-1. Introduction

1.1. This section presents the requirements for submitting design calculations.

2030-2. Format

2.1. Design analysis information shall be organized into bound volumes of 8½ inches by 11 inches or 11-inch-by-17-inch-format sheets. All 11-inch-by-17-inch sheets are to be folded to 8½-inch-by-11-inch size.

2030-3. Organization

3.1. Volumes for design analysis are to be bound in a clear sequential order. Each volume shall have a cover indicating project name, project number, discipline, and the date of issuance. Each page shall include the design analysis performed, discipline, and page number. Provide a table of contents for all design analysis volumes that organizes the material into the various disciplines.

2030-4. Design Calculations**4.1. Structural**

- 4.1.1. Calculations shall be performed for all structural systems, components, connections, and details.
- 4.1.2. When computer software is used to perform structural design calculations, include all input and output data, not just representative data.
- 4.1.3. Structural calculations shall be organized into categories. Possible categories include:
- Design parameters
 - Foundations
 - Floor systems
 - Roof systems
 - Columns
 - Wall systems
 - Lateral analysis
 - Miscellaneous structures

4.2. Mechanical

- 4.2.1. Mechanical analyses shall include:
- Heating/cooling loads
 - Building utilities pipe sizing
 - Plumbing fixture counts
 - Piping stress calculations for hot water systems (operating temperatures over 150°F)

- Seismic calculation as required
- Water treatment tests and evaluations
- Acoustical evaluations and recommendations for rotating equipment and distribution systems
- Other calculations required in this handbook

4.3. Electrical

4.3.1. Electrical analyses shall include:

- Lighting levels as noted in the lighting sections (text height on submitted lighting level plans shall be 8-point or 1/16-inch, minimum)
- Voltage drop
- Demand loads; include diversification per the National Electrical Code (NEC)
- Available short-circuit ampacity
- Coordination study

4.4. Fire Protection

4.4.1. Fire protection analysis shall include:

- Fire entry size and flow

2040-1. Computer-Aided Design and Drafting (CADD) Standards

- 1.1. Drawings for all new BIA school facilities must be produced to consistent CADD standards using the version of AutoCAD current at the time of the Statement of Work. The drawing formats, fonts, layouts, line weights, layer conventions, file naming, sheet naming, and all other symbology are to follow the procedures outlined in the A/E/C CADD Standard manual unless specifically stated otherwise. It is the responsibility of all parties producing drawing information to abide by the approved standards. Electronic files shall be clean, clearly organized, and free of all extraneous drawing information. Multiple tabs for sheets within a single CADD file are not acceptable; each drawing sheet must be a separate file.

2040-2. Drawing Organization

- 2.1. Drawing volumes will be limited to 99 sheets. If a project requires more than 99 sheets, the set shall be broken into additional volumes at logical delineation points; however, drawings for any single discipline shall not be divided between two volumes. Sequencing, sheet names, and arrangement shall follow the guidelines in the A/E/C CADD Standard manual. Unnecessary white space is to be avoided and the information shown must be applicable to the project and organized in a logical and clear manner.

2040-3. Drawing Format

- 3.1. All production drawing sets are to be placed on size E1 30-inch-by-42-inch sheets. Designers are to use the standard BIA School Design border on all sheets, which will be provided by the BIA Contracting Officer along with associated project numbers and project names. Sheet titles shall clearly define the contents of each sheet, and title block information at each submittal must be as complete as possible. Dimensions on all drawings are to be in imperial units.

2040-4. Drawing Scales

- 4.1. Provide drawings at scales consistent with industry standards and large enough to clearly convey drawing information. Scaling conventions are to follow those presented in the A/E/C CADD Standard manual, and all drawing scales must be clearly stated (not simply shown graphically). The scale for plans must be 1/8 inch equals 1 foot 0 inches or greater. If the plan is too large to fit on the required sheet size in one piece at the required scale, the Designer of Record is to break the plan at a logical point and provide a key plan for ease of navigation. When floor plans are segmented onto separate sheets, an overall plan at a smaller scale must be provided showing the entire plan with clearly readable match lines.

2040-5. Drawing Referencing

- 5.1. All cross-references within a drawing set are to be based upon the sheet reference number. Enlarged drawing information must have back-references

indicating the drawing from which the detail originates. Proper back-referencing should refer the reviewer to the original location of the detail in the drawing set.

2040-6. Location of Project Elements

- 6.1. All floor plans and enlarged plans shall include room numbers and must be present for each relevant discipline. Designs that require structural grids must show the grid on all plans as well as on details and sections where the grid is applicable. Sheets that include plan information of any kind shall include a north arrow.

2040-7. Seals and Signatures

- 7.1. For documents produced by the Designer of Record and by all engineering disciplines, drawings issued at the 100 percent construction documents phase shall include a current professional seal and signature.

2040-8. Drawing Amendments and Revisions

- 8.1. Revisions made to existing drawings shall be shown in clouds and flagged with a revision delta. Layers for revisions should be created that correspond to the revision delta number so that changes can easily be associated with the correct drawing revision package. Earlier revision layers can be turned off, leaving only the current changes highlighted. Revision clouds should encircle only the relevant information, and the revision delta should be placed in a logical and easily read location.
- 8.2. In the event an entire sheet is added, the index drawings shall be modified with clouds and revision deltas identifying the new sheet. The new sheet itself shall have a revision cloud and delta around the sheet number and title.
- 8.3. When reissuing or replacing an entire sheet, the Designer of Record shall show the sheet number and title in a cloud and provide a revision delta.

2040-9. Supplemental Drawings

- 9.1. Occasionally the Designer of Record will need to issue a supplemental drawing to execute a change or provide clarification to the contractor. Supplemental drawings shall be numbered sequentially and a log shall be kept by the Designer of Record that tracks the supplemental drawing number, date, content, and reason for issuance. Provide cross-referencing on the supplemental drawing showing the original sheet and detail location of the information being modified. If the detail is new, provide a cross-reference to the location where the new information will be located in the drawing set. All supplemental drawings must be drawn to an industry standard size and must be clear and legible. The Designer of Record shall assign a prefix for each discipline to the drawing number so the contractor will know who issued the drawing. As an example, architectural supplemental drawings would be designated ASD-#, and structural supplemental drawings would be designated SSD-#.

2040-10. Record Drawings

- 10.1.** Record drawings are to be prepared by the Designer of Record and all of their consultants matching the contractor's as-built conditions of the facility. The record drawings are to be provided in the current version of AutoCAD in .dwg format. Each sheet file shall be provided with all references bound such that when the drawing is open, no additional reference pathing is required. The Designer of Record shall include all model and background files. The drawings shall be clear of all revision clouds and deltas. All previous information in the issue record index shall be removed, and the new title "RECORD DRAWINGS" shall be added with the date of record drawing issuance. The Designer of Record shall provide one full-size set of record drawings to the BIA, as well as a CD, labeled in a professional manner, containing the electronic drawings.

THIS PAGE INTENTIONALLY LEFT BLANK

2050-1. General

- 1.1. The Designer of Record shall produce as part of each submittal package a set of specifications addressing minimum quality and performance standards, execution, product information, and technical or construction requirements. Specifications shall be written so that they are applicable to the requirements of the project at hand.
- 1.2. Project specifications for all design disciplines are to be written using ARCOM MASTERSPEC as published by ARCOM, www.arcomnet.com.

2050-2. Format

- 2.1. Specifications shall be bound in an 8½-inch-by-11-inch book with the project name, project number, table of contents with page numbers for each section, and date clearly identified. The specifications shall adhere to the CSI page and section formats and shall use section numbers and titles as published in the current edition of CSIs *MasterFormat*. Each section in the specifications shall have a heading that shows the section number and the section title. Every page shall have a footer that includes a section number and page number within that section, the section title, and the project number.

2050-3. Coordination

- 3.1. Specifications must complement information presented on drawings. The Designer of Record must review and coordinate their own efforts, and the efforts of their consultants, to ensure that information is not missing, conflicting, or ambiguous. Information provided by the BIA shall be incorporated into the specifications as directed. Any cross-referencing between specifications sections and between specifications and drawings must be checked and coordinated prior to any submittal.

2050-4. Proprietary Specifications

- 4.1. “Brand” or “sole source” products and materials may not be specified. Specifications shall be written that outline a performance level or salient product characteristics that can be met or exceeded by multiple manufacturers. The Designer of Record shall not specify materials and products whose qualities are sufficiently unique that only one product will satisfy the requirements.

2050-5. Record Specifications

- 5.1. Record specifications are to be prepared by the Designer of Record and all of their consultants matching the contractor’s as-built information. The record specifications are to be provided in the latest version of Microsoft Word. The specifications shall be clear of all comments and revision marks. The Designer of Record shall provide one set of record specifications to the BIA, as well as a CD, labeled in a professional manner, containing the electronic information.

THIS PAGE INTENTIONALLY LEFT BLANK

2060-1. General

- 1.1. Cost estimates shall be prepared and submitted as set forth in the Designer of Record's contract and in Section 2010 of this handbook.

2060-2. Basic Estimates and Their Use

- 2.1. Base estimates on the best cost data available, adjusted for the project location, and include an escalation factor for the projected midpoint of construction.
 - 2.1.1. The cost estimate will be used as a guide by the BIA in determining if the bids received are fair and reasonable.

2060-3. Special Cost Considerations for Indian Reservations

- 3.1. Research local conditions for each project to determine what factors (if any) should be used to customize the cost estimate to reflect local bidding conditions at the time of the bid. Construction costs on Indian reservations are impacted by numerous factors that do not normally apply in other areas. Examples of special impact factors include:
 - 3.1.1. **TERO Tax.** Obtain current Tribal Employment Rights Office TERO requirements for each project and add them to the overall project cost.
 - 3.1.2. **Davis-Bacon Wage Rates.** Current published rates should be compared to the Designer of Record's estimate database. Any increase due to higher prevailing wage rates should be added to the estimate.
 - 3.1.3. **State Tax.** Evaluate state tax requirements and include them in the estimate as appropriate.

2060-4. Format

- 4.1. The format of the cost estimates shall be as described below and as set forth in the Designer of Record's contract and in Section 2010 of this handbook.
 - 4.1.1. Costs for all site- and building-related costs shall be organized using the Construction Specifications Institute (CSI) *MasterFormat* numbering system.
 - 4.1.2. Provide a separate cost estimate for each building involved in the project as if it were to be bid individually.
 - 4.1.3. Provide a separate cost estimate for each alternative involved in the project.
- 4.2. **Predesign Submittal Format**
 - 4.2.1. **Building Construction Cost.** Use historical data such as that published in *Means Square Foot Costs* or similar sources. Provide the source of cost information.
 - 4.2.2. **Site, Civil, and Play Field Costs.** Provide a unit cost breakdown for each specific area of work. Include measured units, cost per unit, and total cost.

- 4.2.3. *Cost Summary.* Provide a cover sheet that summarizes all costs, special cost impacts, and escalation to the midpoint of construction.
- 4.3. **20 Percent Schematic Design, 40 Percent Design Development, 70 Percent Preliminary Construction Documents, and 99 Percent Completed Construction Documents Submittal Format**
- 4.3.1. *Building Construction Cost.* Provide a detailed materials take-off estimate for all building components. Provide both a material and labor cost for each item. Use equipment costs where appropriate. Use of lump sum or square foot costs is not acceptable.
- 4.3.2. *Site, Civil, and Playfield Costs.* Provide the same information as required for building costs.
- 4.3.3. *Cost Summary.* Provide a cover sheet that summarizes all costs, special cost impacts, and escalation to the midpoint of construction.

SAMPLE CONSTRUCTION COST ESTIMATE SUMMARY FORMAT

Project Name:
Project Location:
BIA Project Number:

Prepared by:
Date Prepared:
Bid Date:

Project Description: (including building area, number of stories, type of construction, and type of use)

CSI	Summary Description	Mat'l	Labor	Total	Cost/S.F.	% of Total
1.0	Special and General Conditions					
2.0	Site Work and Demolition					
3.0	Concrete					
4.0	Masonry					
5.0	Metal					
6.0	Carpentry					
7.0	Thermal & Moisture Protection					
8.0	Doors & Windows					
9.0	Finishes					
10.0	Specialties					
11.0	Equipment					
12.0	Furnishings					
13.0	Special Construction					
14.0	Conveying Systems					
15.1	Plumbing					
15.2	Heating, Ventilating & Air Conditioning					
16.0	Electrical					
	SUBTOTAL					
	Special Conditions *					
	SUBTOTAL					
	General Contractor's Overhead ___%					
	General Contractor's Profit ___%					
	SUBTOTAL					
	Escalation					
	TOTAL					

THIS PAGE INTENTIONALLY LEFT BLANK

3000-1. Introduction

- 1.1. This section presents guidelines and recommendations for incorporating sustainable design into BIA school projects. These guidelines and recommendations support the overall goal of designing, building, and operating high-performance buildings. Sustainable design building practices can substantially reduce or eliminate negative environmental impacts in new buildings; they also reduce operating costs, enhance building longevity, increase student and faculty productivity, and reduce potential health problems resulting from poor indoor air quality.
- 1.2. These recommendations are based on the U.S. Green Building Council's (USGBC) Leadership in Energy and Environmental Design (LEED) New Construction program, otherwise referred to in this handbook as LEED-NC.

THIS PAGE INTENTIONALLY LEFT BLANK

3010-1. General

- 1.1. It is the explicit goal of the Bureau of Indian Affairs to apply the LEED-NC Version 2.2 guidelines to the design of all educational and associated dormitory/residential facilities governed by the standards in this handbook. It is required that these facilities be formally certified under LEED-NC Version 2.2 to a rating of Silver.
- 1.2. The Designer of Record is required to obtain a copy of the LEED-NC *Reference Guide for New Construction & Major Renovations*, Version 2.2, First Edition, October 2005 from the U.S. Green Building Council (www.usgbc.org). The Designer of Record is required to compile sufficient documentation to support the design of the project to the specified level of certification, according to the LEED-NC submission requirements.
- 1.3. The design team members, under the direction of the team's designated LEED manager, are required to coordinate with the contractor and the BIA to produce all documentation required by the certification program to support the LEED points being pursued on a particular project. This documentation is considered a project deliverable to the BIA as part of the requirements for project deliverables under the terms and conditions of the design contract.

THIS PAGE INTENTIONALLY LEFT BLANK

3020-1. Working with the LEED-NC Rating System

- 1.1. The specific credits in the LEED-NC rating system provide guidelines for the sustainable design and construction of buildings of all sizes. LEED-NC addresses the following general categories:
 1. Sustainable Sites
 2. Water Efficiency
 3. Energy and Atmosphere
 4. Materials and Resources
 5. Indoor Environmental Quality
 6. Innovation in Design
- 1.2. While it is recognized that specific site and regional climatic conditions will influence the design of each facility in differing ways, the available credits in the rating system may be applied in any combination that will result in the specified rating. However, it is strongly recommended that priority consideration be given to those credits that address energy efficiency/performance and conservation of natural/sustainable resources. These credits are generally included in credit categories 2, 3, and 4 above.
- 1.3. It is also important to recognize that there may be more than a single credit or category that supports the whole-building approach to achieving a particular LEED-NC credit point. For example, in order to achieve maximum energy performance and efficiency of the HVAC system (and, thus, the entire building), it may be necessary to specify certain materials, building envelope systems, and lighting systems, etc., to further enhance and improve an otherwise “efficient” HVAC system. Every consideration should be given to viewing the entire facility design as an integrated whole when developing strategies to achieve maximum energy efficiency/performance and conservation of natural/sustainable resources.
- 1.4. Finally, it is required that each BIA educational facility project comply with the seven prerequisites specified in the various credit categories in the LEED-NC rating system. These prerequisites represent fundamental requirements of sustainable design, and must be given the highest level of priority and consideration.

THIS PAGE INTENTIONALLY LEFT BLANK

3030-1. LEED-NC Certification – Designer of Record Responsibilities

- 1.1. This section outlines the basic requirements for each LEED-NC rating system prerequisite and available credit, and suggests some possible technologies and strategies that should be carefully considered for all new BIA school facility projects.
- 1.2. The objective of these guidelines is to assist the Designer of Record in developing a whole-building approach to achieving the highest level of sustainable design possible for the funds available.
- 1.3. The following outline of the LEED-NC rating system is intended to orient the Designer of Record to the system, but note that it does *not* supersede the more detailed requirements and descriptions contained in the LEED-NC *Reference Guide for New Construction & Major Renovations*, Version 2.2. Each prerequisite or credit is discussed in terms of a brief requirements summary, applicable options within the credit, Designer of Record design control, and potential design strategies.

3030-2. LEED-NC Prerequisite Requirements**2.1. Sustainable Sites (SS)****2.1.1. *Prerequisite 1 – Construction Activity Pollution Prevention***

Requirements Summary: Comply with the more stringent of 2003 EPA Construction General Permit requirements *or* local erosion and sedimentation control standards and codes to design an erosion and sedimentation control (ESC) plan specific to the site. Important objectives include:

- Preventing loss of soil during construction by storm water runoff and/or wind erosion, including protecting topsoil by stockpiling it for reuse
- Preventing sedimentation of storm sewers or receiving streams
- Not polluting the air with dust and particulate matter

Designer of Record Design Control: Yes.

Potential Strategies: Incorporate in the ESC plan temporary and permanent seeding, mulching, earth dikes, silt fencing, sediment traps, and sediment basins.

2.2. Energy & Atmosphere (EA)**2.2.1. *Prerequisite 1 – Fundamental Commissioning of the Building Energy Systems***

Requirements Summary: Comply with the LEED-NC v. 2.2 *Reference Guide* for a specified commissioning process.

Designer of Record Design Control: Yes, in coordination with the BIA.

Potential Strategies: Although LEED-NC allows the commissioning authority to be employees of design team firms as long as the individuals are not associated directly with the design of the project, there may be less potential for conflict if the BIA retains the services of a commissioning authority as a separate consultant to the design team.

2.2.2. Prerequisite 2 – Minimum Energy Performance

Requirements Summary: Comply with specific sections of ASHRAE/IESNA 90.1 Energy Standard for Buildings Except Low-Rise Residential Buildings (without amendments), as stipulated in LEED-NC. **Note that the Energy Policy Act and the requirements in Chapter 11 of this handbook stipulate that all new BIA school facilities shall achieve an energy performance level at least 30 percent above the ASHRAE standard.**

Designer of Record Design Control: Yes.

Potential Strategies: Design the building envelope, HVAC, lighting, and other systems in a whole-building approach to maximize energy performance, either in compliance with the applicable ASHRAE 90.1 requirements *or* local code requirements if they follow the minimum requirements of the U.S. Department of Energy standard process for commercial energy code determination, whichever is more stringent. It should be noted that the BIA is requiring that energy consumption exceed ASHRAE 90.1 for all major educational facility buildings. Refer to Chapter 11 of this handbook for more detailed potential strategies under this prerequisite.

2.2.3. Prerequisite 3 – Fundamental Refrigerant Management

Requirements Summary: Specify base building HVAC&R systems that contain *no* CFC-based refrigerants.

Designer of Record Design Control: Yes.

Potential Strategies: Self-explanatory; for existing buildings, there are strategies that apply for the phased replacement of existing noncompliant refrigerants.

2.3. Materials & Resources (MR)

2.3.1. Prerequisite 1 – Storage & Collection of Recyclables

Requirements Summary: Provide facilities for recycling paper, corrugated cardboard, glass, plastics, and metals.

Designer of Record Design Control: Yes.

Potential Strategies: Provide a central collection facility in the building, and also consider collection locations in individual work areas to enhance the recycling program. This includes an articulated recycling materials area in the trash Dumpster area. Program space and facility requirements for this function shall be coordinated with the building user and the BIA to conform to local needs.

2.4. Indoor Environmental Quality (EQ)

2.4.1. *Prerequisite 1 – Minimum IAQ (Indoor Air Quality) Performance*

Requirements Summary: Meet the minimum requirements of Section 4-7 of ASHRAE 62.1 Ventilation for Acceptable Indoor Air Quality. Ventilation systems must be designed using the Ventilation Rate Procedure *or* applicable local code, whichever is more stringent. Naturally ventilated buildings must comply with ASHRAE 62.1, paragraph 5.1.

Designer of Record Design Control: Yes.

Potential Strategies: Self-explanatory; balance the impacts of ventilation rates for good indoor air quality with overall energy performance to optimize energy performance and occupant health.

2.4.2. *Prerequisite 2 – Environmental Tobacco Smoke (ETS) Control*

Requirements Summary: Limit smoking in buildings to mitigate negative effects on building occupants, according to one of the following options:

- Option 1: Prohibit smoking inside buildings.
- Option 2: Prohibit smoking inside buildings except in designated smoking areas where the environment is isolated according to specified procedures.
- Option 3: For residential buildings only, prohibit smoking in the common areas of the building, and provide other specific smoke seals in walls and on doors.

Designer of Record Design Control: Yes.

Potential Strategies: Self-explanatory.

3030-3. LEED-NC Credit Requirements

3.1. Sustainable Sites (SS)

3.1.1. *Credit 1 – Site Selection*

Requirements Summary: Do not develop buildings or portions of building projects that are located on certain sites or portions of sites that meet the six specific criteria listed in LEED-NC.

Designer of Record Design Control: **No; except that if there is a portion of a site designated by the BIA that can be built upon to avoid the listed site restrictions, every effort should be made by the Designer of Record to comply.**

Potential Strategies: Do not select a restricted site, and avoid selection of sites that have restricted areas as specified in the listed criteria.

3.1.2. Credit 2 – Development Density & Community Connectivity

Requirements Summary: Construct or renovate facilities on compliant sites according to one of the following options:

- Option 1: Select a previously developed site that is also located in a minimum development density area of 60,000 square feet per acre.
- Option 2: Select a previously developed site that is also located within 1/2 mile of a residential zone or neighborhood with an average density of 10 units per acre *and* that is within 1/2 mile of at least 10 of the listed community services *and* that has pedestrian access between the building and the services.

Designer of Record Design Control: **No; this is generally a site-specific criterion that will be determined prior to the selection of the Designer of Record.**

Potential Strategies: Select compliant sites.

3.1.3. Credit 3 – Brownfield Redevelopment

Requirements Summary: Develop on a contaminated site according to an ASTM E1903-97 Standard Guide for Environmental Site Assessments: Phase II Environmental Site Assessment Process *or* on a brownfield site as defined by a local, state, or federal governmental agency.

Designer of Record Design Control: **No.**

Potential Strategies: Select a brownfield site and conduct required remediation prior to development.

3.1.4. Credit 4 – Alternative Transportation

3.1.4.1. Credit 4.1 – Public Transportation Access

Requirements Summary: Locate the project site close to public transportation according to one of the following options:

- Option 1: Within 1/2 mile of commuter rail or a subway station.
- Option 2: Within 1/4 mile of one or more stops for at least two public bus lines.

Designer of Record Design Control: No.

Potential Strategies: Self-explanatory.

3.1.4.2. Credit 4.2 – Bicycle Storage & Changing Rooms

Requirements Summary: Provide secure bicycle storage for 5 percent of the building occupants (students and faculty/administration) *and* provide shower and changing facilities for 0.5 percent of full-time employees (faculty and administrative staff).

Designer of Record Design Control: Yes.

Potential Strategies: Self-explanatory.

3.1.4.3. Credit 4.3 – Low-Emitting & Fuel Efficient Vehicles

Requirements Summary: Encourage the use of low-emission and fuel efficient vehicles through one of the following options:

- Option 1: Provide low-emitting vehicles to full-time equivalent (FTE) occupants and preferred parking for those vehicles.
- Option 2: Provide preferred parking for low-emitting vehicles for 5 percent of the total vehicle parking capacity of the site; include signage.
- Option 3: Install alternative-fuel refueling stations on the site.

Designer of Record Design Control: Yes.

Potential Strategies: Self-explanatory.

3.1.4.4. Credit 4.4 – Parking Capacity

Requirements Summary: Limit on-site parking capacity according to one of the following options:

- Option 1: Size parking capacity to meet, but not exceed, minimum local zoning requirements (or these standards), *and* designate 5 percent of the total parking spaces provided as preferred parking locations for car pools and van pools.
- Option 2: N/A; projects must provide parking for more than 5 percent of FTEs according to these standards.
- Option 3: **For residential portions of the projects**, size the parking to meet but not exceed the local zoning requirement (if applicable), and provide infrastructure and support programs to facilitate shared vehicle usage such as car pool drop-off areas, designated parking for

van pools, or car-share services, ride boards, and shuttle services to available mass transit systems.

- Option 4: N/A; the elimination of parking is not practical or appropriate for educational facilities.

Designer of Record Design Control: Yes; BIA parking standards as established elsewhere in this handbook will likely govern compliance with this credit.

Potential Strategies: Self-explanatory.

3.1.5. Credit 5 – Site Development

3.1.5.1. Credit 5.1 – Protect or Restore Habitat

Requirements Summary: Preserve or restore open space according to one of the following options:

- Option 1: On greenfield sites, limit site disturbance according to specific development aspects of the site as specified in LEED-NC.
- Option 2: On previously developed sites, restore or protect native or adapted vegetation on a minimum of 50 percent of the site area (excluding the building footprint).

Designer of Record Design Control: Yes.

Potential Strategies: Specify site disturbance restrictions in Division 01 of the specifications, delineate the same restrictions on the site construction drawings, *and* enforce compliance, or design the site to provide the required habitat restoration requirements. Some specific construction strategies include:

- Erect a construction fence at the drip lines of existing trees to remain.
- Preserve existing trees with a relocation plan.
- Fence off areas of nondisturbance, including native grasses, shrub areas, and other high-quality specimens.

3.1.5.2. Credit 5.2 – Maximize Open Space

Requirements Summary: Provide a high ratio of open space to development footprint on the building site according to one of the following options:

- Option 1: Provide vegetated open space to exceed local requirements by at least 25 percent.
- Option 2: Provide vegetated open space equal to the building footprint area where no local requirements exist.

- Option 3: Provide a minimum of 20 percent vegetated open space where the local zoning requirement is specified as 0 percent.

Designer of Record Design Control: Yes.

Potential Strategies: The objective of this credit is to minimize the building footprint to allow for more vegetated open space on development sites. Situate buildings and development areas to minimize disturbance by avoiding long driveways and working with existing grades.

3.1.6. Credit 6 – Stormwater Design

3.1.6.1. Credit 6.1 – Quantity Control

Requirements Summary: Limit the disruption of natural hydrology by reducing impervious cover, increasing on-site infiltration, and managing storm water runoff according to one of the following options:

- Option 1: Existing imperviousness is less than or equal to 50 percent; design storm water management of the site so that developed storm water runoff rates do not exceed the existing conditions prior to development, or protect receiving stream channels from excessive erosion.
- Option 2: Existing imperviousness is greater than 50 percent; design storm water management of the site that decreases the volume of storm water runoff by 25 percent from the 2-year, 24-hour design storm.

Designer of Record Design Control: Yes.

Potential Strategies: Design the site to maintain natural storm water flows by promoting infiltration; minimize impervious surfaces; design for the reuse of storm water for landscape irrigation, toilet and urinal flushing, custodial uses, or other nonpotable uses on-site and within the building.

3.1.6.2. Credit 6.2 – Quality Control

Requirements Summary: Design a storm water management plan that reduces impervious cover, promotes on-site infiltration, eliminates contaminants, removes pollutants from storm water runoff, and captures and treats the storm water runoff from 90 percent of the average and annual rainfall at the site; employ best management practices (BMPs) as specified in LEED-NC.

Designer of Record Design Control: Yes.

Potential Strategies: Use alternative site surfaces, including pervious paving systems, and nonstructural techniques, including

rain gardens, vegetated swales, disconnection of imperviousness, and rainwater recycling to reduce imperviousness and promote infiltration and reduce pollutant loadings.

Low-impact development, environmentally sensitive design, and other sustainable design strategies should be used to integrate natural and mechanical treatment systems such as constructed wetlands, vegetated filters, and open channels to treat storm water runoff.

For playground areas, use a pervious material such as engineered wood fibers or recycled rubber mulch for surfacing.

Note that vegetated roof systems are not considered a viable solution for BIA facilities and are not allowed under any circumstances. Constructed wetlands are also disallowed unless specifically approved by the BIA.

3.1.7. Credit 7 – Heat Island Effect

3.1.7.1. Credit 7.1 – Non-Roof

Requirements Summary: Reduce localized heat gradients over a minimum of 50 percent of the site hardscaped area according to one of the following options:

- Option 1: Provide shade (within five years of occupancy), use paving materials with a solar reflectance index (SRI) of at least 29, or use open grid paving systems.
- Option 2: Locate at least 50 percent of parking spaces under cover; roofs used to cover parking must have an SRI of at least 29.

Designer of Record Design Control: Yes.

Potential Strategies: Shade the developed areas of the site with effective vegetation. Provide shade in play and recreational areas and for play structures. Utilize high-reflectance materials for hardscape areas and for materials used in play and recreation areas. Locate parking under shade structures or landscaping, or under the building. Take advantage of grass paving systems in areas of low traffic use and in overflow parking areas.

3.1.7.2. Credit 7.2 – Roof

Requirements Summary: Reduce localized heat gradients on roofs according to one of the following options:

- Option 1: Use roofing materials that have a minimum SRI of 78 for low-sloped roofs and 29 for steep-sloped roofs over a minimum of 75 percent of the roof surface area.

- Option 2: Note that the BIA will not allow the use of “green roof” or vegetated roof systems on these projects.
- Option 3: Note that the BIA will not allow the use of “green roof” or vegetated roof systems on these projects.

Designer of Record Design Control: Yes.

Potential Strategies: Self-explanatory.

3.1.8. Credit 8 – Light Pollution Reduction

Requirements Summary: Reduce development impact on the nocturnal environment for both interior and exterior lighting according to specific criteria outlined in LEED-NC.

Designer of Record Design Control: Yes.

Potential Strategies: Use full-cutoff luminaires, low-reflective surfaces, and low-angle spotlights, applicable to interior and exterior environments. Ensure lighting design is only for the required safety and comfort of all areas.

3.2. Water Efficiency (WE)

3.2.1. Credit 1 – Water Efficient Landscaping

3.2.1.1. Credit 1.1 – Reduce by 50%

Requirements Summary: Reduce potable water consumption for irrigation by 50 percent from a calculated midsummer baseline case.

Designer of Record Design Control: Yes.

Potential Strategies: Consider plant species for their low water need and adaptability to the site’s climate; make use of captured and recycled rainwater, graywater sources, and climate-based irrigation controllers that will aid in providing a high-efficiency irrigation system. Minimize the use of highly irrigated turf areas that are not required for a functional purpose.

3.2.1.2. Credit 1.2 – No Potable Water Use or No Irrigation

Requirements Summary: Achieve WE Credit 1.1 and use only nonpotable irrigation sources as stipulated in LEED-NC, or install landscaping that does not require permanent irrigation systems.

Designer of Record Design Control: Yes.

Potential Strategies: Make use of native and adapted plant varieties that do not require additional irrigation

3.2.2. *Credit 2 – Innovative Wastewater Technologies*

Requirements Summary: Reduce generation of wastewater according to one of the following options:

- Option 1: Reduce potable water use for building sewage conveyance by 50 percent.
- Option 2: Treat a minimum of 50 percent of wastewater on-site to tertiary standards.

Designer of Record Design Control: Yes.

Potential Strategies: Use water-conserving or waterless plumbing fixtures. Consider using captured storm water or graywater for sewage conveyance, or on-site wastewater treatment systems, including packaged biological nutrient removal systems, constructed wetlands, and high-efficiency filtration systems.

3.2.3. *Credit 3 – Water Use Reduction*

3.2.3.1. Credit 3.1 – 20% Reduction

Requirements Summary: Reduce potable water usage in the building by 20 percent (not including irrigation), after meeting the Energy Policy Act of 1992 fixture performance requirements.

Designer of Record Design Control: Yes.

Potential Strategies: Use water-conserving or waterless plumbing fixtures, and/or occupant sensors to reduce potable water demand. Consider using captured storm water or graywater for nonpotable sewage conveyance and custodial uses.

3.2.3.2. Credit 3.2 – 30% Reduction

Requirements Summary: Same as 3.1, but to 30 percent.

Designer of Record Design Control: Yes.

Potential Strategies: Same as 3.1.

3.3. Energy & Atmosphere (EA)

3.3.1. *Credit 1 – Optimize Energy Performance*

Requirements Summary: Optimize energy performance according to one of the options below (which also achieves compliance with EA Prerequisite 2):

- Option 1: Whole-building energy simulation, Performance Rating Method; energy model compared to a baseline building performance rating according to ASHRAE/IESNA 90.1 (without amendments), ranging from 10.5 percent to 42 percent, with 10 possible credit points.

- Option 2: Prescriptive compliance path; N/A (this is for small office buildings).
- Option 3: Prescriptive compliance path according to certain provisions of the standard; only 1 credit point available.

Designer of Record Design Control: Yes.

Potential Strategies: Earning points under this credit requires a whole-building approach, involving the building envelope, HVAC&R systems, lighting, and other systems. The Designer of Record should make every effort to achieve the maximum number of points possible under this credit, respecting possible budgetary and other project limitations. **Note that the BIA requires the energy performance of all new facilities to achieve at least a 30 percent improvement over baseline building performance as defined in this credit requirement. This will earn a minimum of 6 points under this credit.**

3.3.2. Credit 2 – On-Site Renewable Energy

Requirements Summary: Use on-site renewable energy systems to offset or supplement building energy costs; a possible 3 points are available under this credit, based on offsetting from 2.5 percent to 12.5 percent of the building's energy cost with on-site renewable energy sources. Conform to the requirements of the Energy Policy Act and Chapter 12 of this document, which require 3 percent on-site generation of the total amount of electricity consumed; in fiscal year 2010, this will increase to 5 percent.

Designer of Record Design Control: Yes.

Potential Strategies: Provide a cohesive site and building design that incorporates the harvesting of solar, wind, geothermal, low-impact hydro, biomass, and biogas strategies; ensure the functionality for harvesting the chosen renewable energy process by using it on-site. Meeting the requirements for this credit can also earn credit points under EA Credit 1 and other energy-related credits.

3.3.3. Credit 3 – Enhanced Commissioning

Requirements Summary: Implement a specific commissioning process that is in addition to the requirements of EA Prerequisite 1.

Designer of Record Design Control: **No; the commissioning authority (CxA) must be contracted separately from the design and construction team, either by the Designer of Record for additional fees, or directly by the BIA.**

Potential Strategies: Prescribed by LEED-NC; involving commissioning design review, commissioning submittal review, and creating a systems manual.

3.3.4. *Credit 4 – Enhanced Refrigerant Management*

Requirements Summary: Specify base building HVAC&R systems that use refrigerants according to one of the following options:

- Option 1: Use *no* refrigerants.
- Option 2: Select refrigerants that minimize or eliminate the emission of compounds that contribute to ozone depletion according to a specified formula; compliance also requires that fire suppression systems use no ozone-depleting substances (CFCs, HCFCs, or halons).

Designer of Record Design Control: Yes.

Potential Strategies: Either design the facility without mechanical or refrigeration equipment, or utilize base building systems that comply with the specified prescriptive and performance standards; compliance with this credit will result in compliance with EA Prerequisite 3, but compliance with EA Prerequisite 3 does not result in compliance with this credit.

3.3.5. *Credit 5 – Measurement & Verification*

Requirements Summary: Develop and implement a measurement and verification (M&V) plan according to the International Performance Measurement & Verification Protocol (IPMVP) Volume III: *Concepts and Options for Determining Energy Savings in New Construction*, April 2003; either Option B: Energy Conservation Measure Isolation, or Option D: Calibrated Simulation (Savings Estimation Method 2).

Designer of Record Design Control: Yes.

Potential Strategies: In addition to the development of the M&V plan, install necessary metering equipment in the building to measure energy use, and create accountability for energy use.

3.3.6. *Credit 6 – Green Power*

Requirements Summary: Provide a minimum of 35 percent of the building's electricity from renewable sources by engaging in at least a two-year renewable energy contract.

Designer of Record Design Control: **No; the BIA must contract for the required renewable energy sources independently of the design and construction contracts.**

Potential Strategies: Self-explanatory.

3.4. Materials & Resources (MR)

3.4.1. *Credit 1 – Building Reuse*

3.4.1.1. Credit 1.1 – Maintain 75% of Existing Walls, Floors & Roof

Requirements Summary: This credit applies to the renovation of existing buildings only, according to stipulated criteria, and is therefore **not applicable under these design standards**.

3.4.1.2. Credit 1.2 – Maintain 95% of Existing Walls, Floors & Roof

Requirements Summary: Same as Credit 1.1, but to 95 percent.

3.4.1.3. Credit 1.3 – Maintain 50% of Interior Non-Structural Elements

Requirements Summary: This credit applies to the renovation of existing buildings only, according to stipulated criteria, and is therefore **not applicable under these design standards**.

3.4.2. Credit 2 – Construction Waste Management

3.4.2.1. Credit 2.1 – Divert 50% From Disposal

Requirements Summary: Recycle and/or salvage at least 50 percent of nonhazardous construction and/or demolition waste from the construction site.

Designer of Record Design Control: Yes.

Potential Strategies: Specify these requirements in Division 01 of the project specifications and enforce compliance during construction.

3.4.2.2. Credit 2.2 – Divert 75% From Disposal

Requirements Summary: Same as Credit 2.1, but to 75 percent.

Designer of Record Design Control: Yes.

Potential Strategies: Same as Credit 2.1.

3.4.3. Credit 3 – Materials Reuse

3.4.3.1. Credit 3.1 – 5%

Requirements Summary: Use salvaged, refurbished, or reused materials such that the sum of these materials constitutes at least 5 percent of materials used on the project, on a materials cost basis.

Designer of Record Design Control: Yes.

Potential Strategies: Specify the use of these materials in the project specifications and enforce compliance during construction; common examples include:

- Recycled concrete aggregates for concrete base and retaining wall backfill
- Masonry products for retaining walls
- Salvaged site furniture or play structures

- Wood products for fencing and play structures
- Other appropriate materials that may be found in the *GreenSpec Directory* or other materials resource publications

3.4.3.2. Credit 3.2 – 10%

Requirements Summary: Same as Credit 3.1, but to 10 percent.

Designer of Record Design Control: Yes.

Potential Strategies: Same as Credit 3.1.

3.4.4. Credit 4 – Recycled Content

3.4.4.1. Credit 4.1 – 10% (post-consumer + 1/2 pre-consumer)

Requirements Summary: Use materials with recycled content such that the sum of post-consumer recycled content *plus* 1/2 of the pre-consumer content constitutes at least 10 percent of the materials used in the building, on a materials cost basis.

Designer of Record Design Control: Yes.

Potential Strategies: Specify the use of these materials in the project specifications and enforce compliance during construction; common examples include:

- Domestic steel products, including fabricated steel joists and trusses. Structural steel has a high recycled content.
- Recycled steel in play structures and site furniture.
- Recycled plastics in place of wood for benches and play structures.
- Concrete aggregates and admixtures including fly ash and glass for parking lots and playgrounds.
- Aluminum framing products, including window and storefront framing.
- Light-gauge steel framing. Recycled content of light-gauge steel framing varies.
- Underslab base course. Consider using crushed concrete.
- Concrete aggregates and admixtures; common examples include fly ash or blast furnace slag in the mix design. Use a 25 percent maximum replacement for cementitious materials. Consider using crushed concrete as coarse aggregate.
- Concrete aggregates and admixtures including fly ash and glass for parking lots and playgrounds.

- Wood products, including fabricated site structures.
- Masonry products.
- Other appropriate materials that may be found in the *GreenSpec Directory* or other materials resource publications.

3.4.4.2. Credit 4.2 – 20% (post-consumer + 1/2 pre-consumer)

Requirements Summary: Same as Credit 4.1, but to 20 percent.

Designer of Record Design Control: Yes.

Potential Strategies: Same as Credit 4.2.

3.4.5. Credit 5 – Regional Materials

3.4.5.1. Credit 5.1 – 10% Extracted, Processed & Manufactured Regionally

Requirements Summary: Use building materials and products that have been extracted, harvested, or recovered, *and* manufactured within a 500-mile radius of the site, such that these materials constitute at least 10 percent of the materials used in the building, on a materials cost basis.

Designer of Record Design Control: Yes; to the extent that compliant materials and products are available.

Potential Strategies: Specify the use of these materials in the project specifications and enforce compliance during construction; common examples include:

- Domestic steel products, including fabricated steel joists and trusses. Specify that the steel shall be fabricated within a 500-mile radius.
- Aluminum framing products, including window and storefront framing. Specify that the aluminum framing products shall be manufactured within a 500-mile radius.
- Light-gauge steel framing. Specify that the framing shall be manufactured within a 500-mile radius.
- Concrete aggregates and admixtures. Specify that the concrete materials shall be quarried within a 500-mile radius. Consider specifying that the cement be manufactured within a 500-mile radius. Precast fabricators shall be located within a 500-mile radius.
- Masonry products. Specify that the masonry units shall be manufactured within a 500-mile radius.
- Wood products. Specify that the wood products shall be manufactured within a 500-mile radius.

- Play structures manufactured within a 500-mile radius.
- Other appropriate materials that may be found in the *GreenSpec Directory* or other materials resource publications.

3.4.5.2. Credit 5.2 – 20% Extracted, Processed & Manufactured Regionally

Requirements Summary: Same as Credit 5.1, but to 20 percent.

Designer of Record Design Control: Yes.

Potential Strategies: Same as Credit 5.1.

3.4.6. Credit 6 – Rapidly Renewable Materials

Requirements Summary: Use rapidly renewable building products and materials (made from plants that are typically harvested within a 10-year or shorter cycle) for a minimum of 2.5 percent of the value of all building materials and products used on the project, on a materials cost basis.

Designer of Record Design Control: Yes.

Potential Strategies: Specify the use of these materials in the project specifications and enforce compliance during construction; examples include:

- Bamboo, wool, cotton insulation, agrifiber products, linoleum, wheatboard, strawboard, and cork
- Wood sheathing; consider using oriented-strand board (OSB) made from poplar or Monterey pine
- Other appropriate materials that may be found in the *GreenSpec Directory* or other materials resource publications

3.4.7. Credit 7 – Certified Wood

Requirements Summary: Use certified wood products and materials (certified according to the Forest Stewardship Council's (FSC) Principles and Criteria) for a minimum of 50 percent of the value of all wood-based building materials and products used on the project, on a materials cost basis.

Designer of Record Design Control: Yes.

Potential Strategies: Specify the use of these materials in the project specifications and enforce compliance during construction; only applies to permanently installed materials and products. Furniture may be included *only* if it is consistently included in applicable MR Credits 3–7. Consider the use of FSC wood for shade structures.

3.5. Indoor Environmental Quality (EQ)

3.5.1. *Credit 1 – Outdoor Air Delivery Monitoring*

Requirements Summary: To ensure proper performance, install permanent monitoring systems that provide feedback on the performance of the ventilation systems, and that provide alarms features when ventilation performance varies more than 10 percent from designed set points.

Designer of Record Design Control: Yes.

Potential Strategies: Install CO₂ and airflow measurement equipment that regulates the HVAC systems to maintain designed ventilation set points, and/or include alarms that notify occupants of possible deficiencies in ventilation performance in manually controlled systems.

3.5.2. *Credit 2 – Increased Ventilation*

Requirements Summary: Increase breathing zone outdoor air ventilation rates to all occupied spaces by at least 30 percent above minimum rates required by ASHRAE 62.1 for mechanically ventilated spaces *or* design natural ventilation systems to comply with Carbon Trust Good Practice Guide 237 [1998].

Designer of Record Design Control: Yes.

Potential Strategies: For mechanically ventilated spaces, consider using heat recovery systems to minimize the additional energy consumption associated with higher ventilation rates. For naturally ventilated spaces, comply with the eight steps prescribed in the Carbon Trust Guide.

3.5.3. *Credit 3 – Construction IAQ Management Plan*

3.5.3.1. Credit 3.1 – During Construction

Requirements Summary: Develop and implement an indoor air quality (IAQ) management plan for the construction phase of the building development according to standards specified in LEED-NC.

Designer of Record Design Control: Yes.

Potential Strategies: Adopt an IAQ management plan that is designed to protect the permanent HVAC system from accumulating contaminants during the construction phase of the project. Consider specifying the sequencing of materials installation to avoid contamination of permanent absorptive materials in the building, including insulation, carpet systems, and gypsum board. This credit must be coordinated with EQ Credits 3.2 and 5 with respect to proper filtration media.

3.5.3.2. Credit 3.2 – Before Occupancy

Requirements Summary: Develop and implement an IAQ management plan for the preoccupancy phase of the building development according to one of the following options:

- Option 1: Full-building outside air flush-out according to specified criteria under two possible optional procedures.
- Option 2: Conduct air quality testing and demonstrate that contaminants comply with specified criteria.

Designer of Record Design Control: Yes.

Potential Strategies: Perform a full-building outside air flush-out or test the air contaminant levels according to specified procedures. This credit must be coordinated with EQ Credits 3.2 and 5 with respect to proper filtration media.

3.5.4. Credit 4 – Low-Emitting Materials

3.5.4.1. Credit 4.1 – Adhesives & Sealants

Requirements Summary: Specify *all* adhesives and sealants used in the project (located within the building envelope's waterproofing system and site installed) to comply with specified VOC limitations.

Designer of Record Design Control: Yes.

Potential Strategies: Specify the use of these materials in the project specifications and enforce compliance during construction. **Compliance under this credit can also be achieved through the implementation of alternative strategies specified in LEED-NC in cases where compliant products are not available or practical for use in the project.**

3.5.4.2. Credit 4.2 – Paints & Coatings

Requirements Summary: Specify *all* paints and coatings used in the project (located within the building envelope's waterproofing system and site installed) to comply with specified VOC limitations.

Designer of Record Design Control: Yes.

Potential Strategies: Specify the use of these materials in the project specifications and enforce compliance during construction. **Compliance under this credit can also be achieved through the implementation of alternative strategies specified in LEED-NC in cases where compliant products are not available or practical for use in the project.**

3.5.4.3. Credit 4.3 – Carpet Systems

Requirements Summary: Specify *all* carpet systems, including pad and adhesives, to comply with the Carpet and Rug Institute's Green Label Plus program and specified VOC limitations.

Designer of Record Design Control: Yes.

Potential Strategies: Specify the use of these materials in the project specifications and enforce compliance during construction. **Compliance under this credit can also be achieved through the implementation of alternative strategies specified in LEED-NC in cases where compliant products are not available or practical for use in the project.**

3.5.4.4. Credit 4.4 – Composite Wood & Agrifiber Products

Requirements Summary: Specify *all* wood and agrifiber products used on the interior of the building (located within the building envelope's waterproofing system and site installed or shop applied) that contain no urea formaldehyde resins.

Designer of Record Design Control: Yes.

Potential Strategies: Specify the use of these materials in the project specifications and enforce compliance during construction. **Compliance under this credit can also be achieved through the implementation of alternative strategies specified in LEED-NC in cases where compliant products are not available or practical for use in the project.**

3.5.5. Credit 5 – Indoor Chemical & Pollutant Source Control

Requirements Summary: Design building elements and systems to minimize and control pollutant entry into the building, and later cross-contamination of regularly occupied areas; specific requirements include permanent entryway walk-off mats, separated exhaust of garages, housekeeping/laundry spaces, and copy/printing rooms, and inclusion of permanently installed MERV 13 filtration media on HVAC systems.

Designer of Record Design Control: Yes.

Potential Strategies: Install walk-off mats, deck-to-deck partition systems around potentially contaminating spaces, and isolated ventilation systems in potentially contaminating spaces. Further, at building entrances, avoid the use of plants that drop organic matter that may be tracked into the building; be aware also of the air intake locations and do not use high-pollen or fragrant plants in these locations.

3.5.6. Credit 6 – Controllability of Systems

3.5.6.1. Credit 6.1 – Lighting

Requirements Summary: Provide individual lighting control systems for a minimum of 90 percent of the building occupants *and* provide lighting controllability for all shared multi-occupant spaces.

Designer of Record Design Control: Yes.

Potential Strategies: Provide occupant-controlled lighting for task lighting, and occupancy sensors to control energy usage associated with lighting systems.

3.5.6.2. Credit 6.2 – Thermal Comfort

Requirements Summary: Provide individual comfort controls for a minimum of 50 percent of building occupants *and* provide comfort system controllability for all shared multi-occupant spaces.

Designer of Record Design Control: Yes.

Potential Strategies: Design controllability of comfort systems to comply with ASHRAE 55 Thermal Environmental Conditions for Human Occupancy. Possible control systems include operable windows, hybrid systems integrating operable windows and mechanical systems, individual thermostat controls, local diffusers at the floor, desk, or overhead levels, control of individual radiant panels, and other integrated control systems.

3.5.7. Credit 7 – Thermal Comfort

3.5.7.1. Credit 7.1 – Design

Requirements Summary: Design HVAC systems and building envelope to meet the requirements of ASHRAE 55.

Designer of Record Design Control: Yes.

Potential Strategies: Compliance with this credit is performance based, and involves a whole-building approach to the design of the HVAC and other building systems to comply with the specified standard.

3.5.7.2. Credit 7.2 – Verification

Requirements Summary: Agree to implement a thermal comfort survey of the building occupants within 6 to 18 months after occupancy, and develop a corrective action plan, if necessary, based on survey results.

Designer of Record Design Control: **No; the BIA will conduct the required surveys as a post-occupancy activity; the Designer of Record may be requested to assist with development of any corrective action plan.**

Potential Strategies: Self-explanatory.

3.5.8. Credit 8 – Daylight & Views

3.5.8.1. Credit 8.1 – Daylight 75% of Spaces

Requirements Summary: Design the building to provide daylight to prescribed levels in a minimum of 75 percent of all regularly occupied spaces according to one of the following options:

- Option 1: Achieve a minimum glazing factor of 2 percent, according to the calculation method specified in LEED-NC.
- Option 2: Using a computer simulation, demonstrate that a minimum daylight illumination level of 25 foot candles is achieved, according to specified daylight conditions.
- Option 3: Demonstrate, through post-occupancy records and measurements, that a minimum daylight illumination level of 25 foot candles is achieved, according to prescribed methods.

Designer of Record Design Control: Yes.

Potential Strategies: Consider building orientation, shallow floor plates, increased building perimeter, exterior and interior permanent shading devices and light shelves, high-performance glazing, and automatic photocell-based controls.

3.5.8.2. Credit 8.2 – Views for 90% of Spaces

Requirements Summary: Design the building to achieve direct line of sight to the outdoor environment between 2.5 feet and 7.5 feet above finished floor elevation for building occupants in a minimum of 90 percent of regularly occupied areas.

Designer of Record Design Control: Yes.

Potential Strategies: Consider lower interior partition heights, interior shading devices, interior glazing in full or partial height partitions, and automatic photocell-based controls.

3.6. Innovation & Design Process (ID)

3.6.1. *Credit 1 – Innovation in Design*

Requirements Summary: There are a maximum of 4 points available under this credit, each subject to review and approval of required documentation.

Designer of Record Design Control: Yes.

Potential Strategies: Substantially exceed a LEED-NC performance credit and/or apply innovative strategies or measures that demonstrate a comprehensive approach and quantifiable environmental/health benefits. Examples include:

- Exceed the prescribed percentage of performance by the next incremental percentage above the highest listed range under Credits SSc5.1, SSc5.2, WEc3.2, EAcl, EAcl, EAcl, MRc2.2, MRc3.2, MRc4.2, MRc5.2, MRc6, MRc7, or EQc2.
- Implement a “green” housekeeping plan using environmentally friendly maintenance materials in indoor environments.
- Implement a signage program that “tells the story” of the sustainable design features of the building; e.g., signs above waterless urinals and dual flush toilets that explain the reason for their use and the natural resources that are being conserved through their use, signs at the recycling center, signs at other visible sustainable design features throughout the building, and a sign in the main lobby summarizing the sustainable design strategies used in the building, which serves as an educational tool in the school environment.
- Review available USGBC credit interpretations and rulings available online.

3.6.2. *Credit 2 – LEED Accredited Professional*

Requirements Summary: At least one principle participant of the project team shall be a LEED Accredited Professional (LEED AP).

Compliance with this credit point is mandatory.

Designer of Record Design Control: Yes.

Potential Strategies: Utilize the LEED AP as the facilitator of the integrated design and construction process. This team member should be the primary manager of the compliance documentation process.

4000-1. Introduction

- 1.1. This chapter shall be used as a guideline in the development and design of all new BIA school facility sites. This shall encompass all outdoor areas, including vehicular and pedestrian areas, recreation areas, and learning areas. The design shall be in conformance with these guidelines unless exceptions to them are granted by the BIA.
- 1.2. Refer to Chapter 1, “General Information,” and Chapter 2, “Presentation of Data,” for required documents, drawing and specifications formats, and other design and submittal requirements not discussed in this chapter.
- 1.3. Additional design and submittal requirements may be required for projects with unusual or highly technical criteria.
- 1.4. As applicable, the Designer of Record shall incorporate the sustainability strategies identified in Chapter 3, “LEED Goals and Guidelines.”
- 1.5. The guidelines in this chapter should be used in conjunction with those in the other chapters in this handbook, and the Designer of Record should coordinate with the other project consultants to be sure all aspects of the school facility are effective and compatible. Coordination between the architect, the civil engineer, and the landscape architect is required.
- 1.6. All design features must be weighed carefully for their initial cost, long-term maintenance cost and needs, durability, and their impact on the environment.

THIS PAGE INTENTIONALLY LEFT BLANK

4010-1. General

- 1.1. For site design, follow all current applicable codes, standards, and laws. For a more general list of codes and standards that apply to BIA educational facilities, refer to Chapter 1, “General Information.” During design, report any required deviations from codes and standards to the Contracting Officer.
- 1.2. Where two codes, standards, or laws are applicable to the topic under review, use the more conservative or more stringent. Consult with the BIA Office of Facilities Management and Construction (OFMC) to resolve any questions or conflicts regarding application of codes and standards.

4010-2. Applicable Codes and Standards

- 2.1. The design criteria shall comply with the guidelines published by or contained in the following:
 - American National Standards Institute (ANSI)
 - American Society for Testing and Materials (ASTM)
 - Americans with Disabilities Act and Architectural Barriers Act Accessibility Guidelines (ADAABAAG)
 - ASTM F1292-99 Standard Specification for Impact Attenuation of Surface Systems Under and Around Playground Equipment
 - ASTM F1292-04 Standard Specification for Impact Attenuation of Surfacing Materials Within the Use Zone of Playground Equipment
 - ASTM F1487-01 Standard Consumer Safety Performance Specification for Playground Equipment for Public Use
 - ASTM F1951-99 Standard Specification for Determination of Accessibility of Surface Systems Under and Around Playground Equipment
 - Bureau of Indian Education *Educational Space Criteria Handbook*
 - Local and state building codes
 - *National Best Practices Manual*
 - National Electrical Code (NEC)
 - National Playground Safety Institute (NPSI)
 - Occupational Safety & Health Administration (OSHA)
 - State, local, tribal, regulatory, health, and environmental agencies
 - U.S. Consumer Product Safety Commission (CPSC) *Handbook for Public Playground Safety*
 - Underwriters Laboratories (UL)
 - Uniform Plumbing Code (UPC)
 - Western Wood Products Association (WWPA)

THIS PAGE INTENTIONALLY LEFT BLANK

4020-1. Introduction

- 1.1. This section shall be used as a guideline for the site evaluation and design process for BIA school facility projects. During this process, the Designer of Record should coordinate with other project consultants, specifically with the civil engineer, the architect, and the landscape architect.
- 1.2. This design process will promote a clear understanding of the site design's feasibility, safety, appearance, constructability, and structural integrity.

4020-2. Site Considerations**2.1. Land Status**

- 2.1.1. Describe the type and status of the land on which the project is to be located. Proper acquisition of the land must precede any design or construction activity.
- 2.1.2. Archaeological clearance must be obtained prior to any construction that may affect existing archaeological sites.
- 2.1.3. Determine the extent of historic preservation requirements for the project via consultation with the Contracting Officer and area office facility manager.

2.2. Efficiency/Economy

- 2.2.1. Select and design materials, systems, and components appropriate to the project requirements.
- 2.2.2. Recognize and respect the existing site features and preserve and/or enhance them to the greatest extent possible.
- 2.2.3. Design systems so as to minimize short- and long-term maintenance.
- 2.2.4. Select environmentally sensible products and practices.

2.3. Accessibility

- 2.3.1. Design the site to meet all applicable requirements under the ADAABAAG and USCA Title 29 § 794, "Nondiscrimination under Federal Grants and Programs."
 - 2.3.1.1. The gripping surface of circular railing or pipe serving as handrails on accessible stairs or ramps, except at ramps within play areas, shall be 2-inch outside diameter (O.D.) railing or an equivalent 1½-inch *nominal* inside diameter standard pipe (1.900-inch O.D.). In play areas, circular handrails on ramps connecting ground level or elevated play components shall have an outside diameter of .95 inch minimum and 1.55 inches maximum (equivalent to 1" to 1¼" nominal inside diameter standard pipe).
 - 2.3.1.2. The clearance between handrails and adjacent surfaces, i.e., walls, posts, shall be 2¼ inches minimum, except handrails serving ramps

and stairs in play areas may have 1½ inches minimum clearance to supporting structures.

2.4. Safety

- 2.4.1. Materials selection should include consideration for potential tripping hazards, head and limb entrapment, and toxic ingredients and materials.
- 2.4.2. Chemicals, materials, and equipment used for maintenance and cleaning activities should be stored in secure locations per all applicable codes and laws.
- 2.4.3. Consider security and safety in site design and layout. In the preliminary stages of design, discussions should occur between the design team and the BIA representatives to determine the level of security desired and needed based on the level of threat. Site designs should consider controlled access, maintaining appropriate clear zones, minimizing blind spots, visibility of approaches, nonlinear vehicular approaches to main entry points, and separation between pedestrian and vehicular zones.
- 2.4.4. Incorporate safety and security features as part of the site design to minimize their appearance as much as possible. Topography, vegetation, water, walls, and decorative bollards can all be used as security features.

2.5. Durability

- 2.5.1. In choosing landscape products and plant materials for the site, consider their resilience and durability around schoolchildren.
- 2.5.2. Choose site features that will be durable in the site's climate. Factors to consider include precipitation, wind, sun, and temperatures (as well as temperature fluctuations). Exposure to particular climatic conditions may cause certain materials to deteriorate faster than others.
- 2.5.3. When choosing a product, consider its ease of repair, restoration, replacement, or resistance to vandalism.

4020-3. Site Design Process

- 3.1. **Site Inventory and Analysis.** All sites should be assessed for all existing site conditions.
 - 3.1.1. Existing site conditions will include existing landforms, slopes, drainage channels and patterns, and other land features, as well as existing structures, existing vegetation, and existing site features such as walks, fences, above- and below-ground utilities, and parking areas (paved or unpaved).
 - 3.1.2. Existing weather patterns, such as prevailing wind direction, precipitation amount, and sun exposure in all seasons should also be included as part of the site inventory.

- 3.1.3. Historic and current on-site activities and uses should also be noted and mapped, including farming, mining, drilling, storage, or waste disposal, and residential, commercial, or existing school uses.
- 3.1.4. Off-site influences, such as site access, views, and negative impacts created by off-site activities and features should be considered during site analysis.
- 3.1.5. Other considerations, which may not be readily apparent, such as soil types, underground water sources, and subsidence areas should also be noted.
- 3.1.6. All existing conditions should be mapped and summarized for reference prior to preliminary site design.
- 3.2. Base information should include a site survey with elevation datum and elevation benchmarks and contour map.
- 3.3. **Preliminary Site Design.** Preliminary site design typically occurs in conjunction with a preliminary program. The program will determine, generally, the activities that will occur on-site as well as the user group size and type. The development of an accurate preliminary program is key to a functional and efficient design process, especially in the preliminary phases. It allows for preliminary sizing and estimates of spaces for specific activities, from parking to playgrounds.
 - 3.3.1. Layouts should emphasize orienting buildings to minimize the effects of summer solar heat load and optimize winter solar gain. Summer prevailing breeze should also be taken advantage of, where feasible, without excessive costs for grading, roads, drainage, landscaping, or other features.
 - 3.3.2. Coordination among the architect, the landscape architect, and the civil engineer for locating the buildings and working with their interior and exterior use configuration is imperative in the function of the site features and circulation. Buildings are the site's primary features, and their layout, location, orientation, and entry points will influence or dictate the location of playgrounds, play courts and fields, sidewalks, parking lots, driveways, and planting beds.
 - 3.3.3. Coordination between the civil engineer and the landscape architect will include addressing overall site layout, site grading, utility infrastructure (existing and proposed), storm drainage, water supply and waste water systems, access, and circulation. Please also refer to the other sections in this chapter and to Chapter 5, "Civil," for more details.
 - 3.3.4. Consider the impact of new construction on existing facilities.
 - 3.3.5. Consider areas for future building or site amenities expansion.
 - 3.3.6. Meet the requirements for flood protection.

3.3.7. During site planning for school play and recreational areas, give close attention to site orientation; proximity to housing, streets, and nearby hazards; the extent of grading involved; and drainage concerns.

3.4. **Final Site Design.** The final portion of the site design process includes everything from a final concept plan through final construction documents. These documents should include final building locations, utilities, and access and circulation routes. The program for these documents should also be finalized, including all numbers and uses for the site.

3.4.1. Site and landscape plans should include accurate representations of all products and site features as noted in all sections of this chapter.

3.4.2. Coordination among the civil engineer, architect, and landscape architect should occur at every step of this stage of the process. Changes in grades, access points, circulation patterns, entry points, and uses will affect the site and landscape designs.

3.4.3. Coordination between the civil engineer and landscape architect should occur on all grading. There should be close coordination in the final fine grading of bed, landscape, and hardscape areas.

3.4.4. The final grading design should create landforms that appear natural, with smooth transitions to existing grades.

3.4.5. A plant palette, including trees, shrubs, ornamental grasses, perennials, annuals, vines, and seed mixes should be nearly finalized at the final concept plan, but should be complete and all plants labeled for the final construction documents.

3.4.6. Site furniture, hard surface materials, wall materials, playground equipment, and all other site materials should be a consideration at the time of the final concept plan; however, all materials should be finalized during the Construction Documents process and included in the final construction documents.

3.4.7. Where emergency access routes around the buildings are required, minimize their visual and physical impact by incorporating them into the walkways, hard surface play areas, and site features where possible.

4030-1. General

- 1.1. The site design should carefully consider access and circulation routes for all levels of circulation, including pedestrians, bicycles, and vehicles. The design should incorporate separate routes for all three levels, minimizing conflicts between users whenever possible.

4030-2. Vehicular Circulation

- 2.1. Vehicular circulation routes should be clear and simple in order to prevent driver confusion when accessing the site. Maintain separate car and bus circulation within the vehicular areas on the site. Also minimize conflicts with pedestrian and bicycle circulation paths.
- 2.2. Entry areas for various types of vehicular traffic should be clearly marked. If conditions and safety concerns allow, there should be a minimum of two driveways for vehicular access into the site (one for buses and service, one for parking and drop-off/pickup). If a single access is preferred or required, separation of buses and service from parking and drop-off/pickup should occur as soon as possible within the site.

2.3. Bus Loading and Unloading

- 2.3.1. A bus loop drive is the required method for bus loading and unloading and should accommodate buses in a parallel parking configuration with a parking lane that is a minimum of 12 feet wide and a drive aisle that is a minimum of 12 feet wide (for a total of 24 feet from flowline to flowline).
- 2.3.2. The number of buses required may vary based on student population and busing distances of students; the bus loading area should be designed for the minimum number of buses required to accommodate student numbers.
- 2.3.3. Buses should not be required to back up while on the school site.
- 2.3.4. The turning radii for all bus use areas are a minimum of 35 feet for interior radii and a minimum of 50 feet for outer curve radii.
- 2.3.5. Locate bus parking spaces close to a main building entry.
- 2.3.6. Provide a curbed sidewalk along the right side (same side as the bus door) of the bus drop-off/pickup lane.
- 2.3.7. Bus pavement shall be heavy duty.

2.4. Passenger Drop-Off/Pickup Driveway

- 2.4.1. Design the passenger vehicle drop-off/pickup area to be separated from bus circulation.
- 2.4.2. Maintain one-way traffic and provide for stacking lengths based on student population.
- 2.4.3. Locate the area near the main building entrance, close to the administration offices, while still providing a barrier between the vehicular

and pedestrian uses. Typical barrier treatments may include distance, topography, vegetation, seat walls, planting beds, decorative bollards, or boulders. Visibility from the building through and to the drop-off/pickup area should not be greatly reduced by the use of barriers.

- 2.4.4. Pavement is to be standard duty if there is no bus or delivery truck access on this drive.
- 2.4.5. The drive is to be a minimum of 24 feet in width.

2.5. Visitor Parking

- 2.5.1. Locate visitor parking near the main building entrance, close to the administration offices, while still providing a barrier between the vehicular and pedestrian uses. Typical barrier treatments may include distance, topography, vegetation, seat walls, planting beds, decorative bollards, or boulders. Visibility from the building through and to the visitor parking area should not be greatly reduced by the use of barriers.
- 2.5.2. Parking space dimensions are a minimum of 9 feet by 18 feet, with 24-foot-wide aisles.
- 2.5.3. Accessible parking spaces should be provided as required per ADAABAAG requirements. Technical section 502.6 “Van Accessible” signs may be omitted if universal parking spaces, i.e., minimum 11 feet wide spaces with minimum 5 feet wide access aisles, are utilized for accessible parking throughout the site.
- 2.5.4. Coordinate with the BIA for the number of parking spaces needed based on student population, expected visitor use, and potential community uses.

2.6. Staff Parking

- 2.6.1. Provide one parking space for each staff member, including spaces for part-time staff and student teachers.
- 2.6.2. Provide a minimum of four parking spaces near the delivery/receiving area for food service and custodial staff.
- 2.6.3. Locate staff parking near visitor parking for economy of pavement design where possible. Staff parking can also be located to one side of the bus parking lot in the area not required for bus traffic.
- 2.6.4. Parking space dimensions are a minimum of 9 feet by 18 feet, with 24-foot-wide aisles.
- 2.6.5. Accessible staff parking spaces should be provided as per ADAABAAG technical requirements.

2.7. Accessible Parking Spaces

- 2.7.1. Comply with BIA requirements and with the ADAABAAG requirements; these supersede any standards listed in this document if different.

- 2.7.2. Provide the minimum number of accessible parking spaces in each parking lot as required by ADAABAAG Chapter 2, Table 208.2.
- 2.7.3. Locate these parking spaces on the shortest accessible route of travel to an accessible building entrance. Where parking serves more than one accessible entrance, accessible parking spaces shall be dispersed and located on the shortest accessible route to the accessible entrances.
- 2.7.4. Where possible, accessible pedestrian routes should not cross drives or vehicular parking areas. If necessary, provide crosswalks painted on the pavement and signs to designate pedestrian rights-of-way. Raised pavement for crosswalks may also be considered.

2.8. Perimeter Curbs

- 2.8.1. Provide 6-inch-high curb to separate car and pedestrian circulation routes.
- 2.8.2. Locate curbs as required to direct the flow of storm water toward storm sewer inlets.
- 2.8.3. Provide curbs at planted islands in parking lots.
- 2.8.4. Provide curbs along drives and adjacent to storm detention ponds or other abrupt slopes adjacent to the drive.
- 2.8.5. Provide wheel stops where parking is perpendicular to the edge of the pavement and curbs are not used. Do not use wheel stops in front of curbs. Wheel stops should be made from recycled material whenever possible.
- 2.8.6. Where a curb separates perpendicular parking and pedestrian circulation walkways, either use wheel stops or increase the walk width to accommodate bumper overhang onto the walk. No walk should have less than 5 feet of walkable area when cars are parked adjacent to it.
- 2.8.7. Straight curb or curb and gutter may be used.

THIS PAGE INTENTIONALLY LEFT BLANK

4040-1. Emergency Vehicle Access and Circulation

- 1.1. Review emergency vehicle access and circulation construction with authorities having jurisdiction.
- 1.2. When possible, walks or paths should accommodate emergency vehicles around the perimeter of buildings where vehicular drives are not present.
- 1.3. Where emergency access routes around the buildings are required, minimize their visual and physical impact by incorporating them into sidewalks, hard surface play areas, and landscape designs where possible.

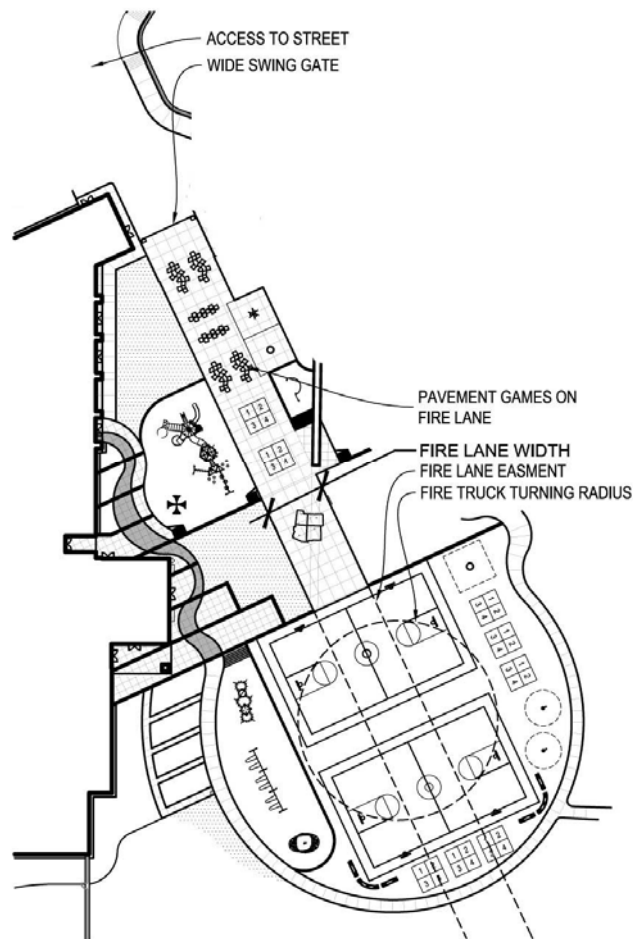
Figure 4040-1:**Emergency Access Incorporated into Hardcourt Play Area, Typical**

- 1.4. Provide removable or hinged bollards or a breakthrough gate at the end of the emergency access path where it meets vehicular drives to prevent use of the path by nonemergency vehicles. Space bollards a minimum of 5 feet on center.

THIS PAGE INTENTIONALLY LEFT BLANK

4050-1. General

- 1.1. Service areas may occur in various locations on the site, including adjacent to main buildings as well as at independent locations. No service areas should be located at primary entry points or at the front of buildings. Typically, service areas provide access for kitchen and building maintenance staff, trash and recycling facilities, delivery drop-off, and other functions that provide valuable services to the students and staff but which are typically unseen or minimally visible.
- 1.2. A fence between play areas and service areas and drives is required.
- 1.3. Additional screening, such as walls or landscape, can be used to reduce the visual impact of the service areas on other areas of the site and adjacent properties.

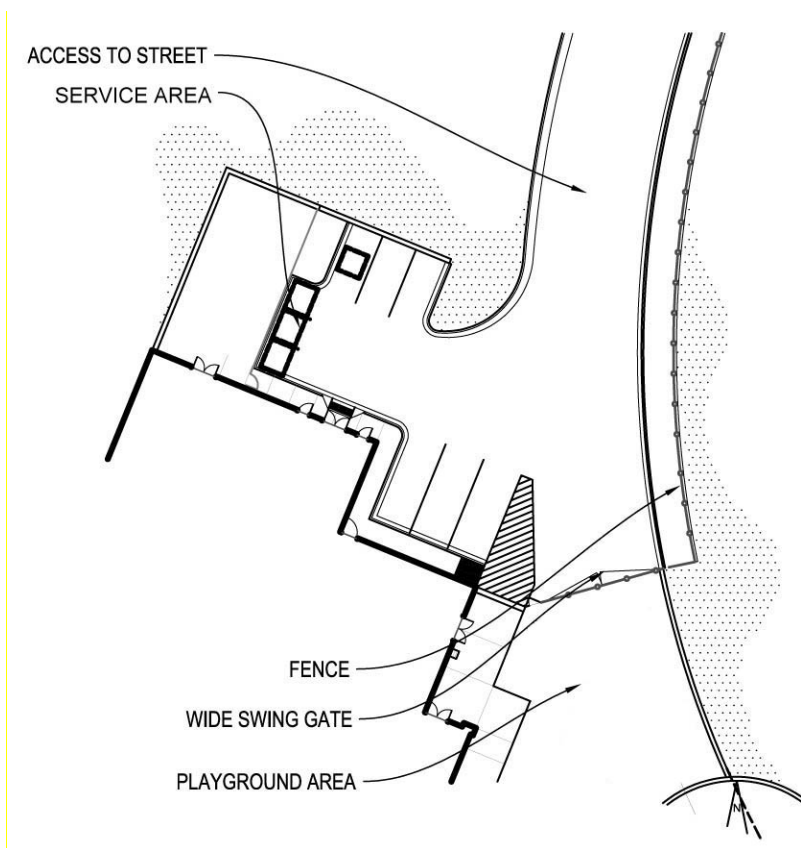
Figure 4050-1: School Building Service Area Adjacent to Playground, Typical**4050-2. Service Drives**

- 2.1. Service drives should, where possible, have a separate access drive into the site. Where an access point is restricted, include it with the bus driveway, because both will require heavy-duty concrete paving to support the larger vehicles.

- 2.2. Service areas should be minimally apparent and not easily accessible to the general school or community population. If additional security is required or desired, a gate could be used. Other operational solutions may include defining delivery and service hours or restricting access to qualified companies or individuals with pass cards.
- 2.3. Provide a T-turn with a minimum 5-foot radius for maneuvering large trucks in all delivery/receiving areas.

4050-3. Service Dock

- 3.1. Each school facility shall be provided with a ramped service dock providing access to the main kitchen facility. The service ramp may provide shared access to the school maintenance facilities if the school plan allows. If not, a separate at-grade service area shall be provided at the school maintenance facilities.
- 3.2. The service ramp shall incorporate a dock with appropriate bumpers and leveling devices as required to service vehicle types that will be providing service to the school facility.
- 3.3. The service ramp shall incorporate a proper drainage system to accommodate the projected water flow into the ramp area.

4050-4. Parking

- 4.1. Provide a minimum of four parking spaces near the delivery/receiving area for food service and custodial staff.
 - 4.1.1. Parking space dimensions are a minimum of 9 feet by 18 feet and there should be clearance to allow vehicles to back up.

4050-5. Trash and Recycling Facilities and Pickup

- 5.1. Pavement is to be heavy duty with a concrete pad area for the Dumpster approach in order to reinforce the area subject to loading when the Dumpster is lifted.
- 5.2. There should be a minimum of one Dumpster and one recycling bin enclosure in each building's service area, even if recycling services will not be initially provided.

4050-6. Site Maintenance Facilities

- 6.1. If a separate facility is required for truck and/or supply storage or a maintenance yard, this facility and the yard area should be fenced with a minimum of 8-foot-high metal or chain-link fencing.
- 6.2. Chemical, gasoline, and oil storage areas should meet all federal, state, and local regulations for safety and security.

4060-1. General Concepts

- 1.1. The site design will need to integrate roads, walks, play areas, turf, and landscape areas into a cohesive site plan. The places children and staff will touch every day include the hard surfaces of walks, plazas, and play areas. These areas are a key element in the overall site design.
- 1.2. If possible, on all hardscape areas, specifically the hardcourt areas, use surfacing that will achieve a solar reflectance index (SRI) value of at least 29 to reduce the on-site heat gain.
- 1.3. General site security and safety features should be considered. Early coordination with the BIA representative will allow the design team to determine the level of threat and design appropriately. These preliminary discussions will assist in determining the number of access points (vehicular, pedestrian, and bicycle), fencing options and requirements, separation of uses needed, and barrier requirements.

4060-2. Walks and Paths

- 2.1. Walks shall provide accessible routes between building exits and destination points on the site.
- 2.2. Pedestrian areas should be separated from vehicular areas by a physical barrier. This physical barrier should be integrated into the site design and not appear as a threatening separation. Typical treatments may include distance, topography, vegetation, seat walls, planting beds, decorative bollards, or boulders. Often these features can provide security and safety as well as places for students to gather, wait for pickup after school, etc. Visibility from the building through and to pedestrian areas should not be greatly reduced by the use of barriers.

2.3. Pedestrian Walks

- 2.3.1. Provide major connecting walks, a minimum of 8 feet wide, from major drop-off drives to major entrances.
- 2.3.2. Major connecting walks at major building entrances and along bus loading and unloading areas are to be a minimum of 8 feet wide.
- 2.3.3. Provide walks from the building to public walks if public walks serve the school site; these are considered minor connecting walks.
- 2.3.4. Walks should be designed to a minimum of 1 percent and a maximum of 5 percent slope in the direction of traffic, and 2 percent or less for all cross-slopes. If a walk exceeds or is equal to 5 percent slope, it shall be designed as a ramp.
- 2.3.5. Walks are to be reinforced (with fiber mesh) concrete and a minimum of 4 inches thick, with a light broom finish. Asphalt or other materials shall not be used for walks.

- 2.3.5.1. Concrete is required for all major access walks.

- 2.3.5.2.** If a walk is to be used for fire access, local jurisdictional requirements will need to be met for thickness of the concrete and width of the surface.

4060-3. Hardcourt Play Areas

- 3.1.** Hardcourt play surfaces for elementary, middle, and high school levels may include but are not limited to:
- Areas for activities that require painted boundaries, such as hopscotch, four-square, and other designed activities
 - Organized team and/or competitive games, such as half- to full-size basketball courts and tetherball
- 3.2.** Hardcourt sizes and programming will vary by grade level. The following guidelines are considered a minimum size for hardcourt areas for each student level:
- Elementary school – 6,000 square feet of hard surface play area
 - Middle school – 9,600 square feet of hard surface play area
 - High school – 9,600 square feet of hard surface play areas
- 3.3.** Kindergarten and pre-kindergarten areas typically combine hard and soft areas for a total of 4,000 to 6,000 square feet (between 50 and 75 square feet per student).
- 3.3.1.** Hard surface areas for the kindergarten and pre-kindergarten level may include educational activities but rarely include organized elements like hopscotch and four-square.
- 3.3.2.** Also see Section 4070 for more information on kindergarten and pre-kindergarten areas.
- 3.4.** At least one accessible route shall directly connect both sides of each court.

Figure 4060-1: Elementary School Hardcourt Play Area, Typical

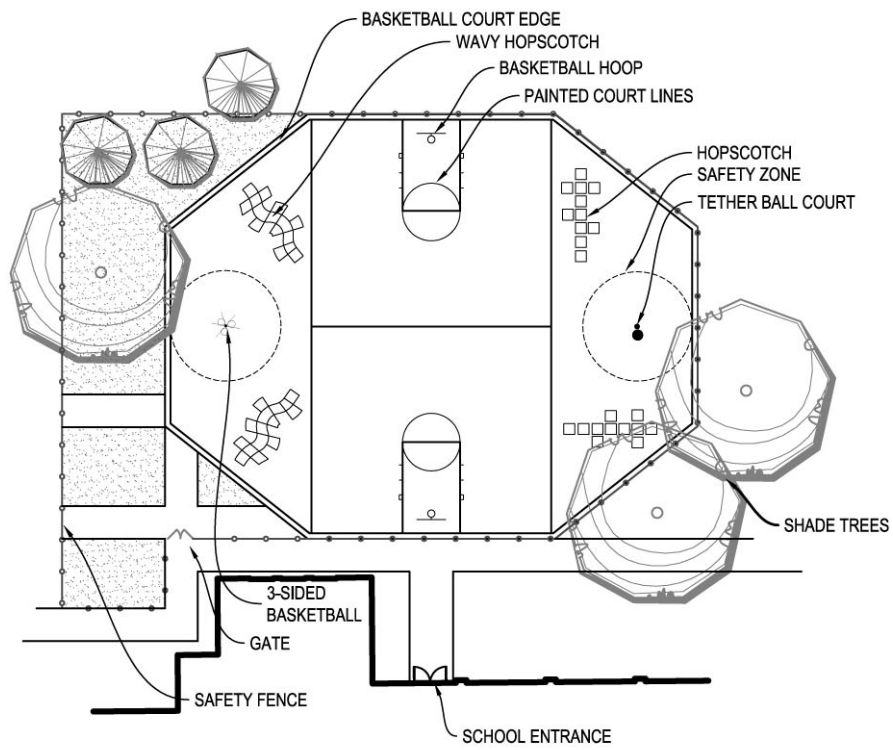
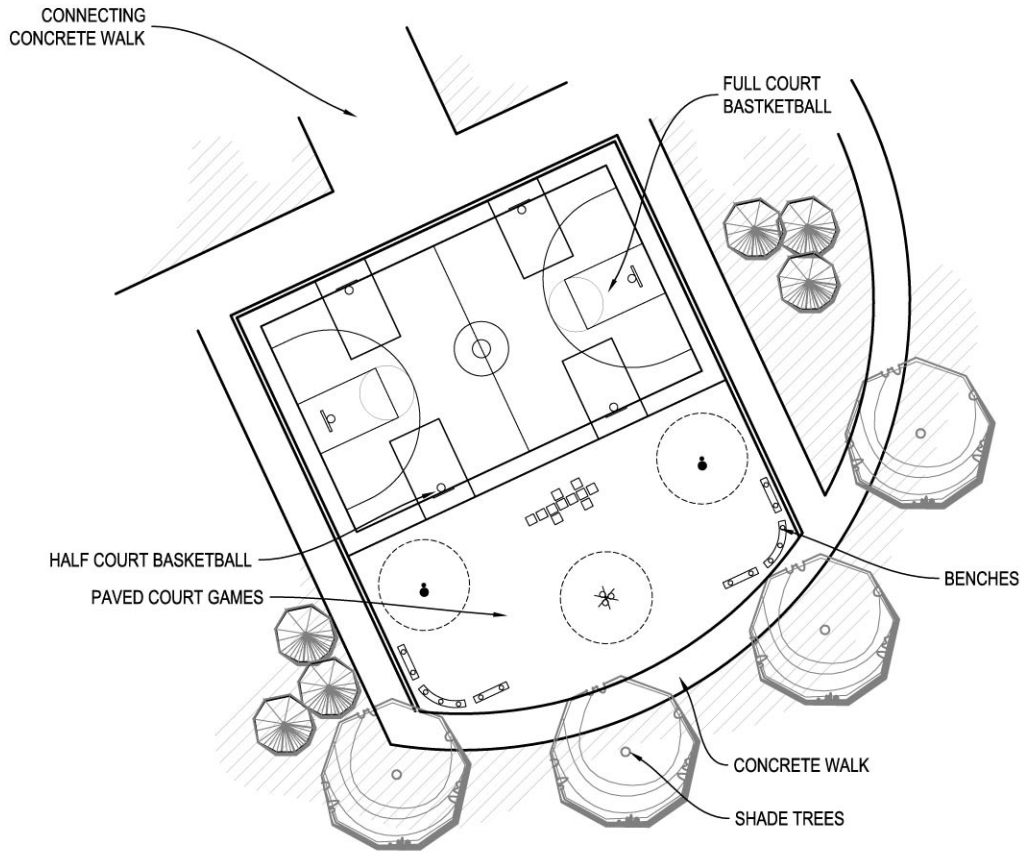

Figure 4060-2: Middle School Hardcourt Play Area, Typical



4070-1. General

- 1.1. Play and recreation areas are required as part of the site design. These areas provide locations for children to play, places to have physical education classes outdoors, and if needed, provide fields for organized sports teams.

4070-2. Playgrounds**2.1. General**

- 2.1.1. Playgrounds should be divided into areas for different aged children, as described more completely below.
- 2.1.2. Please also refer to Section 4060 for more information on hardcourt play areas.
- 2.1.3. All playground designs should meet the requirements of ASTM F1487-01 Standard Consumer Safety Performance Specification for Playground Equipment for Public Use and the *Handbook for Public Playground Safety* published by the U.S. Consumer Product Safety Commission (CPSC).
- 2.1.4. Playground areas should include shaded areas. Trees or shade structures can be used, and are recommended on the southern side of a play area.
- 2.1.5. Provide concrete edging to keep loose fill surface within the bounds of the play area.
- 2.1.6. Surfacing is to be nonsplintering where children may be crawling. Avoid using black surfacing.
 - 2.1.6.1. Playground safety surfacing should be either engineered wood fiber, loose synthetic materials (chopped rubber or plastic), or other pervious material that is also wheelchair accessible. Poured-in-place or mat surfacing is not recommended due to high cost and maintenance concerns.
- 2.1.7. Depress loose fill surface material below edging. Provide an underdrain system and geotextile below loose fill surface.
- 2.1.8. Increase the depth of the soft surface material in areas of high use such as the base of swings and slides.
- 2.1.9. Locate equipment with larger moving parts, such as swings, to the perimeter of the play area or into its own area separated from other play areas. Use fencing or planting beds to prevent children from inadvertently stepping into the path of moving equipment.

2.2. Accessibility

- 2.2.1. Provide ramps and/or transfer points on composite play structures for access to play components on elevated decks. Meet ADAABAAG requirements for the percentage of and number of types of components that are to be accessible by ramp and by transfer deck.

- 2.2.2. Where a play experience occurs at ground level, equivalent opportunity for mobility impaired children must be provided. For example, when a sandbox is provided at ground level, provide a child wheelchair accessible play table and sand tray.

2.3. Separation of Play Areas

- 2.3.1. Provide playground areas to allow for differences in age, ability, and interest.
- 2.3.2. Separation between the pre-kindergarten and kindergarten playgrounds and the primary and intermediate playgrounds should be done through fencing or walls a minimum of 4 feet high.
- 2.3.3. All playground equipment should have the appropriate safety fall-zone distances and in no case shall there be any concrete curb, vegetation, or other nonsafety surfacing within the safety fall-zone area.
- 2.3.4. Follow applicable safety guidelines for different age groups. See the U.S. CPSC *Handbook for Public Playground Safety* for industry standards on safety precautions for playground areas.

2.4. Pre-Kindergarten and Kindergarten Play Area

- 2.4.1. Kindergarten and pre-kindergarten areas typically combine hard and soft areas for a total of 4,000 to 6,000 square feet (between 50 and 75 square feet per student).
- 2.4.2. Provide play activities that include rocking, swinging, balancing, climbing, and sliding.
- 2.4.3. Any pre-kindergarten and kindergarten play areas should be fenced or walled at a minimum 4 feet high.
- 2.4.4. These areas should also be located close to the building and classrooms of the pre-kindergarten or kindergarten level students. This allows for better supervision of and access to the playground area.
- 2.4.5. The area should be designed to include both hard and soft surface areas for diversity of play.

Figure 4070-1: Pre-Kindergarten or Kindergarten Playground Area, Typical

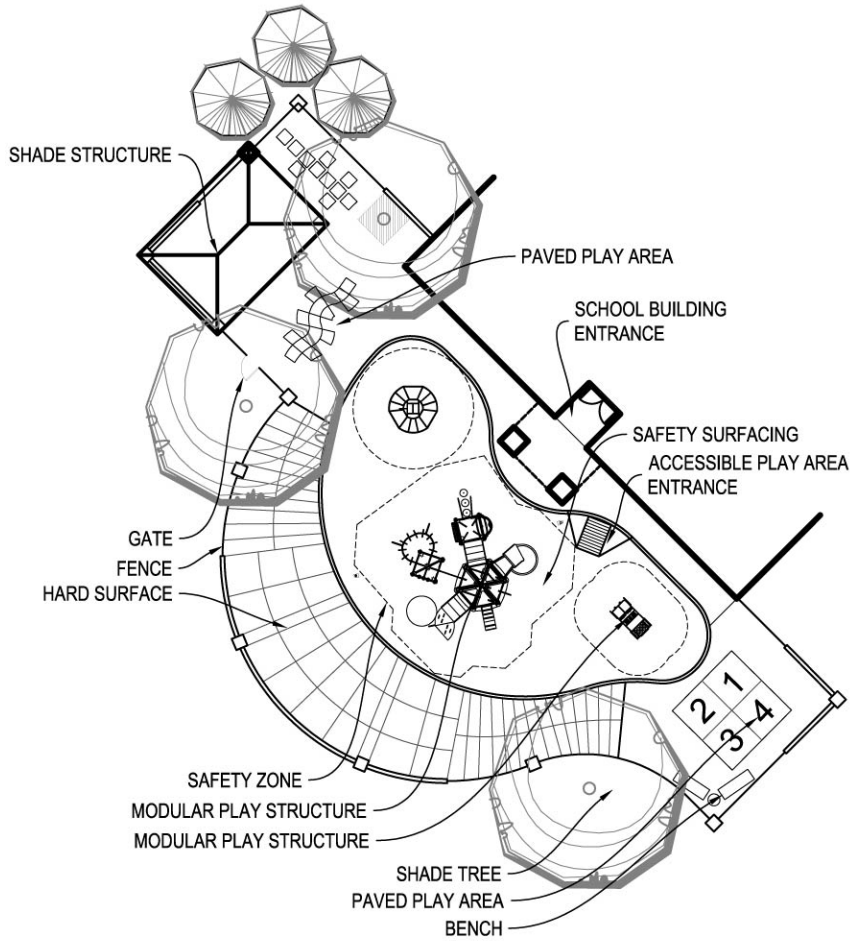

2.5. Primary Play Area

- 2.5.1. Design for grades 1 through 3.
- 2.5.2. The primary play area may be combined with an intermediate play area when space is limited.
- 2.5.3. To limit distractions in the classroom, these areas should be located away from the windows and doors of classrooms that may not be using the playground when others are using it. Landscaped areas or other buffers can also be used.

Figure 4070-2: Primary Playground Area, Typical

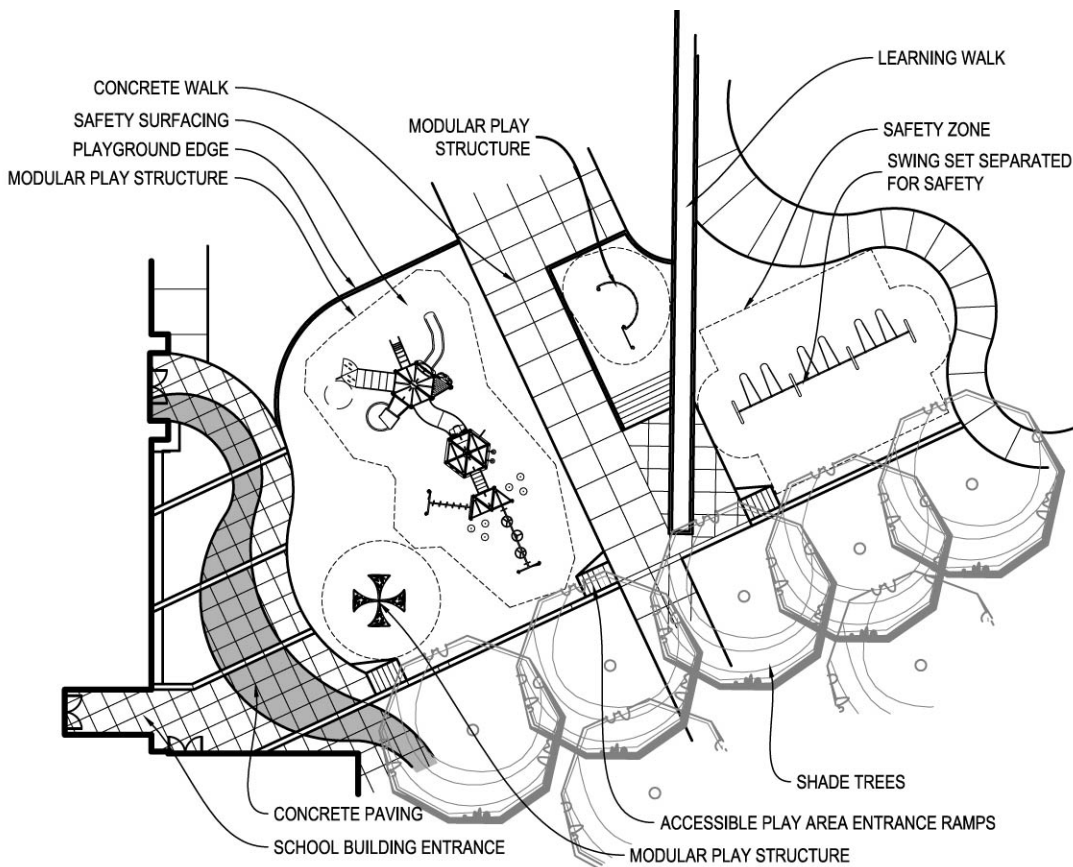

2.6. Intermediate Play Area

- 2.6.1. Design for grades 4 through 6.
- 2.6.2. The intermediate play area may be combined with a primary play area when space is limited.

- 2.6.3. To limit distractions in the classroom, these areas should be located away from the windows and doors of classrooms that may not be using the playground when others are using it. Landscaped areas or other buffers can also be used.

Figure 4070-3: Intermediate Playground Area, Typical

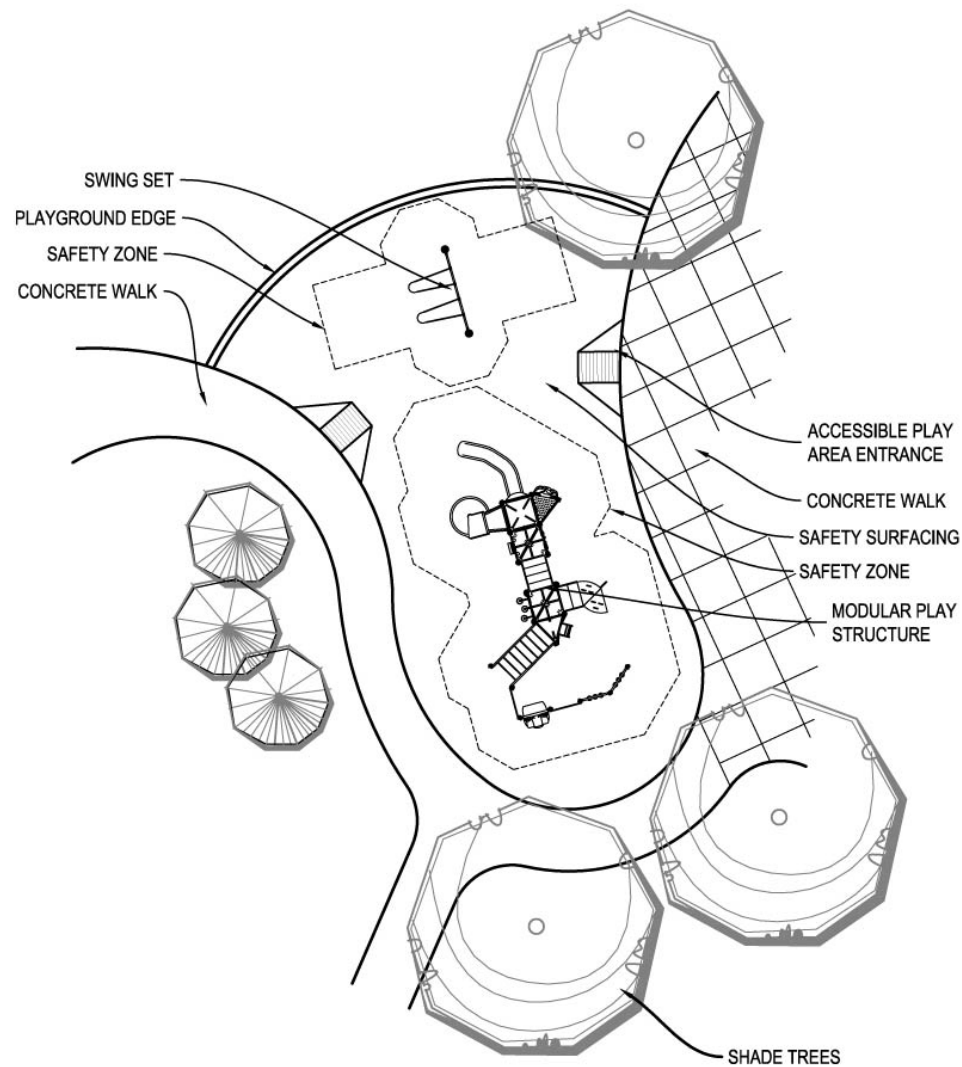

4070-3. Fields and Athletic Facilities

3.1. All of the following facilities are on an as-needed basis, and may not be used at all school levels or all schools within the same level.

3.1.1. Multi-Use Turf Area – All School Levels

3.1.1.1. Grading is to crown at the center of the field and slope to the sidelines when possible. Grades should not exceed 2 percent.

3.1.1.2. Plan for underdrains and irrigation.

3.1.1.3. Plan for portable or combination football/soccer goals.

Figure 4070-4: Multi-Use Turf Area, Typical

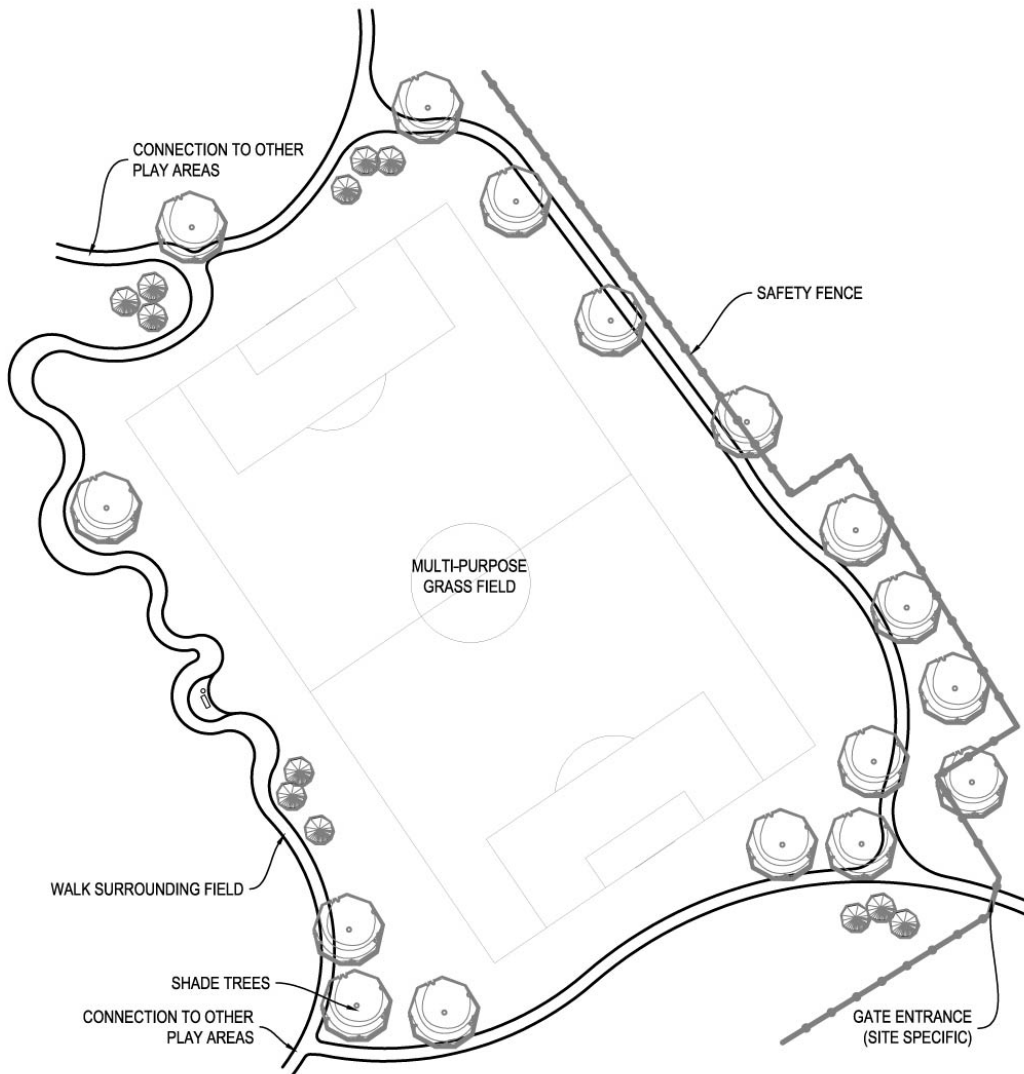

3.1.2. Running Track/Football Field – Middle and/or High School Level

- 3.1.2.1. Plan for an 8-lane, 400-meter running track and football field combination.
- 3.1.2.2. Design the track radius to allow for a soccer and/or football field inside the track.
- 3.1.2.3. Plan for field events that include high jump, long/triple jump, discus, and shot put.
- 3.1.2.4. Plan for a 4-foot-high chain-link perimeter fence surrounding the track, with gates at center field and as needed for maintenance.
- 3.1.2.5. Moveable or permanent stands can be included on one or both sides of the field complex, depending on the facility's regional use or size of expected crowds for football, soccer, or track and field events.

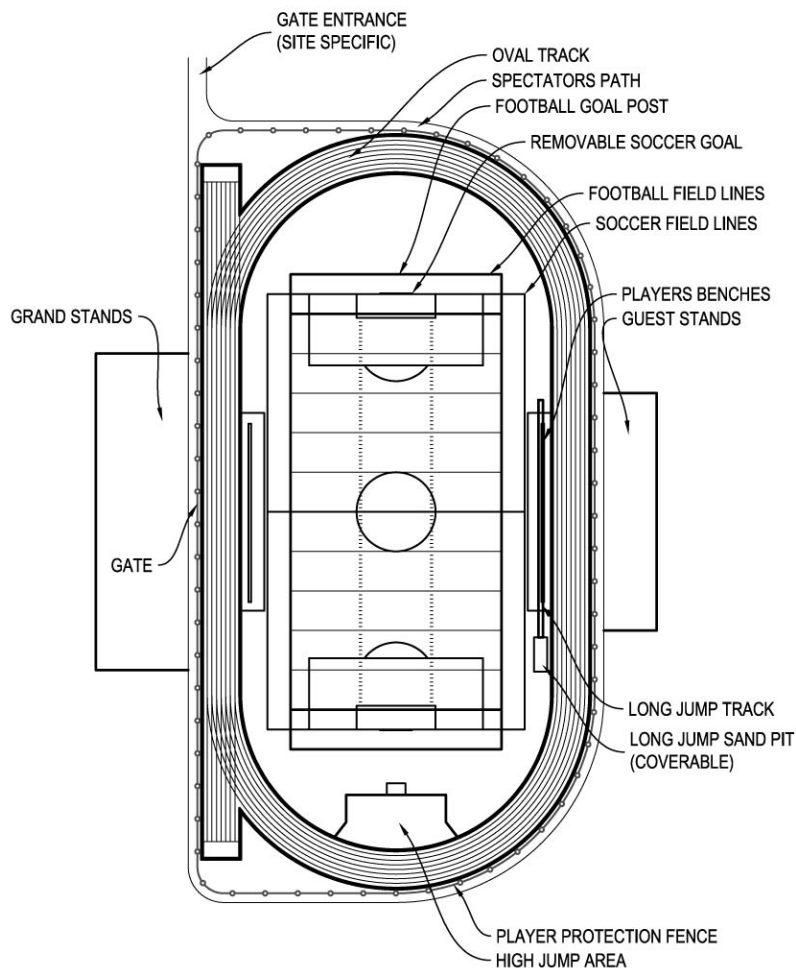
Figure 4070-5: Football Field/Soccer Field/Track Configuration, Typical

3.1.3. Baseball/Softball Field – All Levels

- 3.1.3.1.** Baseball and softball fields should be enclosed if possible with a minimum 6-foot-high chain-link fence along the sides and outfield areas, and a 30-foot minimum height backstop. An additional angled fence on the top of the backstop is recommended as well. Gates should be used for maintenance access.
- 3.1.3.2.** Typical orientation from home plate to second base should be north to northeast, when possible.
- 3.1.3.3.** The field should typically grade away from home plate, with the baselines being level. The slope should not exceed 2 percent, with 1 to 1½ percent preferred.
- 3.1.3.4.** An infield mix, or similar, should be used for the infield surface.
- 3.1.3.5.** If local youth leagues have specific standards on distances, fence heights, and configurations, they should be considered during design.
- 3.1.3.6.** Consideration should be given to areas for team and pitcher/catcher warm-up. A specifically designated zone is not required, but consideration should be given to areas that will be used by teams.

3.2. Accessibility

- 3.2.1.** An accessible route shall connect to the boundary of each area of sport activity. Where multiple sports fields or courts are provided, an accessible route is required to each field or area of sport activity. Accessible routes shall connect to players' benches and coaches' boxes and dugouts.

Figure 4070-6: Softball Field or Primary and Middle School Baseball Field, Typical

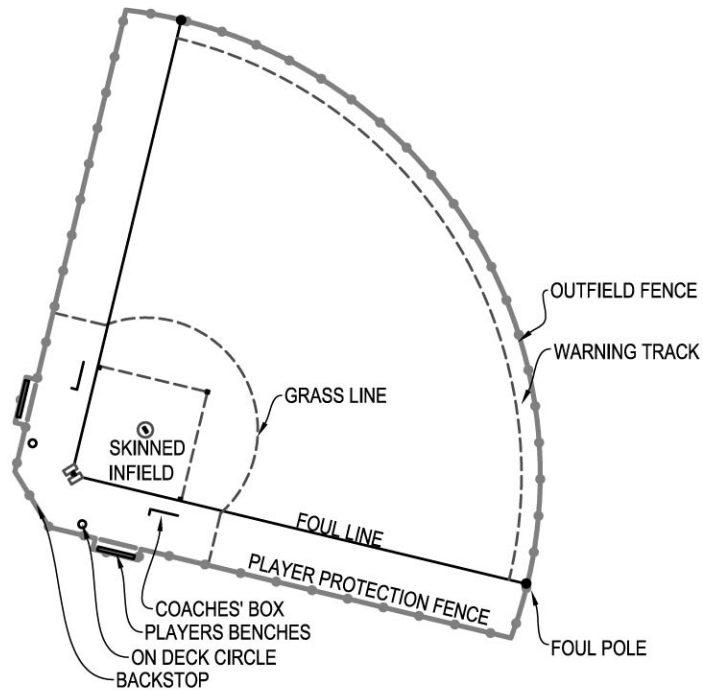
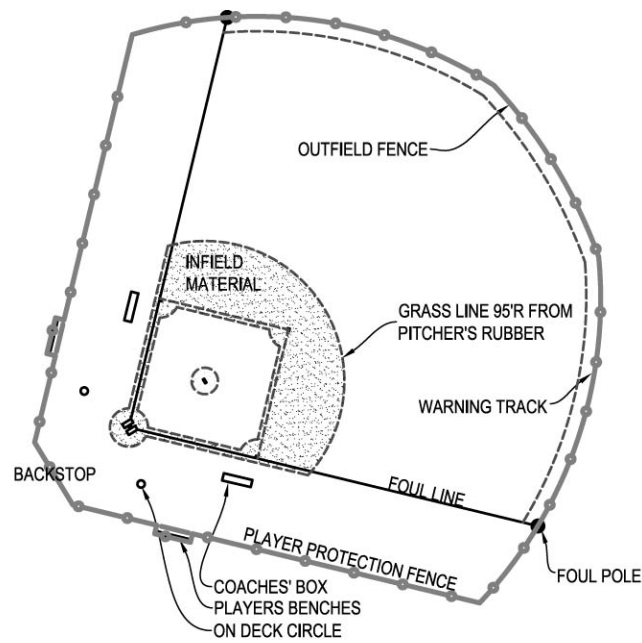

Figure 4070-7: High School Baseball Field, Typical



THIS PAGE INTENTIONALLY LEFT BLANK

4080-1. General

- 1.1. Fencing should be used to limit or contain access to areas. Similar fencing should be used throughout the site.
- 1.2. Fencing materials and styles may include aluminum, steel, coated wire, UV resistant PVC, chain link, rail, and picket. Wood fencing materials are not allowed.
- 1.3. Locate fencing on the curb in high-maintenance areas.
- 1.4. The top and bottom of chain-link fencing selvage shall be knuckled to prevent injury.

4080-2. Site Perimeter Fencing

- 2.1. Provide fencing at the site perimeter adjacent to open water, busy streets, railroad tracks, and where other safety hazards occur.
- 2.2. In some cases, the entire perimeter can and should be fenced. This decision should be discussed with the BIA representative and based on the level of threat.
- 2.3. While perimeter fencing may be an excellent security strategy, consideration should be given to the aesthetic quality and sense of enclosure and entrapment it may create from inside and outside of the site.

4080-3. Fences Interior to the Site

- 3.1. Provide fencing to enclose mechanical yards, equipment, trash/service areas, and where other safety hazards occur.
- 3.2. Provide fencing around any agriculture education areas for safety and security.
- 3.3. Provide fencing around lab areas involving work on or with vehicles, equipment, or animals for security and safety.

4080-4. Playground Fencing

- 4.1. Provide fencing around the playground perimeter where there is a potential for children to run out into parking areas, adjacent streets, and/or other hazardous conditions.
- 4.2. Provide a minimum of 4-foot-high fencing or walls for pre-kindergarten and kindergarten play areas.

4080-5. Athletic Fields

- 5.1. Include perimeter fencing of football field/track facilities.
- 5.2. Baseball and softball fields should have chain-link fencing for backstop and infield areas at a minimum. It is recommended that the entire field be enclosed with gates for maintenance. See Section 4070 for more information.

- 5.3. Design 8-foot-high fencing around the perimeter of physical education fields if there is an admission fee charged for viewing events. Fencing will be lower in front of spectator stands, if applicable.

4080-6. Site Security Fencing

- 6.1. Based on the level of threat for each site, consider providing:
 - An exterior perimeter defense system consisting of site fencing, surveillance camera, and an exterior door access control system
 - Eight-foot-high chain-link fence around all or selected portions of the site with gates to control main vehicular and pedestrian access
- 6.2. While full perimeter fencing may be an excellent security strategy throughout the site, consideration should be given to the aesthetic quality and sense of enclosure and entrapment it may create from inside and outside of the fence, and should be used appropriately and only as needed.

4090-1. General

- 1.1. This section provides guidelines for the Designer of Record relative to the geotechnical evaluation of the site.

4090-2. Geotechnical Report Review

- 2.1. The BIA will provide the Designer of Record with a project geotechnical report. The Designer of Record shall review the report and notify the BIA of any apparent deficiencies. Specifically review the report for conformance with NFPA 5000, Chapter 36, and items on the checklist below.
- 2.2. Where multiple foundation options are provided in the geotechnical report, the Designer of Record shall provide foundation recommendations to the BIA. See Section 9030-4.

4090-3. Geotechnical Report Checklist

- 3.1. In addition to the above, the Designer of Record shall confirm that the following have been addressed in the report where applicable. If the report is deficient, the BIA shall be notified.
 - The site topography is described and all the topographic features and surface water noted that may affect the project.
 - Existing structures or pavements on the site are described, if applicable.
 - Subsurface obstructions, mine shafts, or tunnels are identified and described, if applicable.
 - The results of the subsurface investigation and all laboratory testing and their impacts on the proposed construction are described.
 - Logs of all borings and test pits and results of all laboratory tests as applicable, including soil classification, liquid limit, plastic limit, plasticity index, pH, resistivity, shrink/swell tests, radon, and salinity are included.
 - A contour map of the bedrock surface is included, if applicable.
 - The geotechnical engineer's understanding of the proposed structure(s), including type of construction contemplated, size and height, finished floor elevation, and elevation relative to existing ground elevation is presented and described.
 - Foundation recommendations and design parameters are provided, and the movement potential of each system is quantified.
 - Design criteria are provided for resisting building lateral loads, including laterally loaded piers, soil frictional characteristics, or battered piles, as applicable.
 - Solutions are provided for constructing on expansive soils, as applicable.

- Site seismic information is provided, including soil site class, liquefaction potential, and surface rupture, if applicable.
- Design recommendations regarding slope stability are provided, as applicable.
- Information is presented on water tables as they affect construction and the completed building.
- Lateral design pressures are provided for foundation-wall design and retaining-wall design.
- Footing design parameters for retaining walls are provided.
- Existing fill, if any, is described and information provided on whether the fill must be removed or reworked.
- Recommendations for slab-on-grade or structural floors on grade are provided.
- Voiding requirements under foundation elements, if any, are provided.
- Soil compaction requirements are provided.
- Recommendations for type of cement, minimum air content, maximum water/cement ratio, and minimum strength for concrete elements in contact with soils are provided.
- Information is provided relative to radon and mitigation measures recommended to ensure radon levels in the completed building will not exceed code limits.
- Recommendations for frost heave prevention are provided.
- Excavation and earthwork requirements are provided.
- Vehicular pavement requirements and recommendations are included.
- Perimeter drain and underdrain requirements and details are included as applicable.
- Earth liner recommendations are provided, if applicable.

5000-1. Introduction

- 1.1. This chapter shall be used as a guideline in the development of the site grading, earthwork, utility infrastructure, drainage, water and wastewater systems, paving, and roads for all new BIA school facility projects. Design for all new construction for the BIA shall conform to the guidelines outlined herein, unless exceptions to them are granted by the BIA.
- 1.2. Refer to Chapter 1, “General Information,” and Chapter 2, “Presentation of Data,” for required documents, drawing and specifications formats, and other design and submittal requirements not discussed in this chapter. All documents must meet professional engineering standards and be stamped by the appropriate professional engineer.
- 1.3. Additional design and submittal requirements may apply for projects with unusual or highly technical criteria.
- 1.4. As applicable, the Designer of Record shall incorporate the sustainability strategies identified in Chapter 3, “LEED Goals and Guidelines.”
- 1.5. The guidelines in this chapter should be used in conjunction with those in the other chapters in this handbook, and the Designer of Record should coordinate with the other project consultants to be sure all aspects of the school facility are effective and compatible.
- 1.6. All design features must be weighed carefully for their initial cost, long-term maintenance cost and needs, durability, and their impact on the environment.

5000-2. Quality Control

- 2.1. Quality control shall include, but not be limited to, completing the checklist that appears on the following pages. The criteria in the checklist include all parts of the design outline and should be considered prior to submittal. Verify that the design complies with the design guideline requirements.

Figure 5000-1: General Quality Control Civil Engineering Checklist

Project Name:	Sheet No.:
Job No.:	Page _____ of _____
(EPR) Engineering plan reviewed by:	Date:
(CPR) CAD plan reviewed by:	Date:
(CEFR) CAD electronic file reviewed by:	Date:
(PIC) Principal in charge review:	Date:
(NR) Not required, (REQ) Required	

	REQ	NR	EPR	CPR	CEFR
Sheet elements (e.g., north arrow, dates, scales, etc.)					
Legend					
Jurisdictional general notes (verify current version)					
Designer of Record's general notes					
Note abbreviations used					
Note stating contractor to verify existing site conditions and to notify owner and engineer of any discrepancies					
Key map matches plan					
Match lines match referenced sheets					
References to other sheets accurate					
Basis of bearings					
Benchmark					
Boundary lines on and labeled					
Street names labeled correctly					
Existing and proposed surface features (buildings, walls, walks, curbs, etc.) shown and labeled					
Demolition plans labeled					
Existing and proposed contours shown and labeled					
Existing rights-of-way and easements labeled per title work					
Existing utilities shown and labeled					
Proposed storm sewer system shown and labeled					
Storm profiles verified					
Proposed sanitary sewer system shown and labeled					

	REQ	NR	EPR	CPR	CEFR
Proposed sanitary profile verified					
Proposed water system shown and labeled					
Proposed water profile verified					
Adjacent sites labeled					
Blowup of area around building provided (minimum scale of 1"=20')					
Earthwork cut/fill analysis if requested by client Total site cut _____ yds.; Fill % compaction _____ yds. Total site _____ import/export with a ___% shrink/swell factor					
Check cross sections or use other means to verify earthwork quantities (e.g., +/- on grid)					
If placed on plan, reference geotechnical information					
If grades are above finished floor of building, discuss with architect and structural engineer					
Snow removal/storage areas provided					
Erosion control and SWMP					
Horizontal layout					
Construction details					
Construction documents specifications					
Utilities: gas and electric shown					

5000-3. Site Type

- 3.1.** Each location presents various factors that must be incorporated into the design process. Verify that the following have been considered:
- Historical features that must be preserved
 - Local ordinances pertaining to site design
 - Local tribe mandates varying from BIA regulations
 - Land availability
 - Layout/site features
 - Weather
 - Geotechnical studies
 - Traffic evaluations
 - Existing landscape versus proposed landscape constraints

5000-4. Local Availability

- 4.1.** Verify local availability of spare parts, replacement parts, and service technicians for future maintenance of the equipment and materials specified.
- 4.2.** If equipment is not locally available, determine how long it will take to acquire and verify with the BIA that this time is acceptable.

5000-5. Warranty

- 5.1.** All systems shall have a minimum 1-year warranty from date of substantial completion.
- 5.2.** Labor warranty shall be performed by factory-trained service technicians located within 50 miles of the project site, or a distance as appropriate to the site.

5010-1. General

- 1.1. System integration will influence the criteria needed for each design depending on the constraints specific to each project. All systems are subject to BIA approval, and other systems may be available that are not delineated within this chapter.

5010-2. Civil Systems

- 2.1. General civil systems include the following: streets and roadways, parking and drives, site grading, erosion and sediment control, water systems, sanitary systems, and drainage systems.
- 2.2. The following factors should be considered when evaluating a civil system:
 - Overall initial cost, including materials costs, transportation costs, and labor costs. Maintenance costs should also be considered.
 - Constructability, including the construction schedule, phasing, simplicity, and the number of trades needed to complete the project.
 - Performance of the system and overall integration with all other systems being used.
 - Local as well as outside availability of materials needed.
 - Local expertise, including experience and understanding of the project scope as well as knowledge of construction materials.
 - The need for post-construction maintenance of the system, as well as local expertise in that maintenance.
 - Life cycle of the construction project. The construction season will vary from site to site; shorter seasons may either limit the project scope or encourage efficient construction techniques. These may include prefabricated or premanufactured systems that may be implemented during colder months.
 - Future modifications, including geotechnical settling and compaction, water supply variances, and overall system flexibility and expandability.
 - LEED compliance in all pertinent areas, in order to maximize LEED points. See Chapter 3 for LEED certification requirements.
 - Site layout, including both existing and proposed site configurations and features.
- 2.3. All engineering disciplines involved in the design and construction of BIA educational facilities should coordinate their approaches and systems to ensure alignment of design. Preapproved systems should be given priority, and efficiency as well as cost-effectiveness should influence system choices.

THIS PAGE INTENTIONALLY LEFT BLANK

5020-1. General

- 1.1. Follow all current codes, standards, and laws as they apply to each civil engineering discipline within the design. For a more general list of codes and standards that apply to BIA educational facilities, refer to Chapter 1, “General Information.” During design, report any required deviations from codes and standards to the Contracting Officer.
- 1.2. Where two codes, standards, or laws are applicable to the civil topic under review, use the more conservative or more stringent. Consult with the BIA Office of Facilities Management and Construction (OFMC) to resolve any questions or conflicts regarding codes and standards.

5020-2. Applicable Codes and Standards

- 2.1. The design criteria shall comply with the guidelines published by or contained in the following:

2.1.1. National Fire Code

- National Fire Protection Association (NFPA) National Fire Code (NFC)

2.1.2. Civil Engineering

- American Association of State Highway and Transportation Officials (AASHTO)
- American Concrete Institute (ACI)
- American Society of Civil Engineers (ASCE)
- Americans with Disabilities Act and Architectural Barriers Act Accessibility Guidelines (ADAABAAG)
- Executive Order 11988 Floodplain Management; follow guidelines relevant to civil engineering
- *Manual on Uniform Traffic Control Devices* (MUTCD)
- *Standard Specifications for Construction of Roads and Bridges on Federal Highway Projects*, United States Department of Transportation (USDOT, FHWA)
- *Urban Drainage Design Manual*, Federal Highway Administration (FHWA)

- 2.1.3. **Environmental Engineering.** As related to wastewater, solid waste, and potable water:

- American Society of Civil Engineers (ASCE)
- Clean Air Act (P.L. 88-206), as amended
- Clean Water Act (P.L. 92-500), as amended

- National Environmental Policy Act of 1969 (P.L. 91-190), as amended
- National Sanitation Foundation (NSF) standards
- Resource Conservation and Recovery Act (P.L. 94-580), as amended
- Ten-State Standards for Sewage Works
- Ten-State Standards for Water Works
- U.S. Environmental Protection Agency (EPA)
- U.S. Public Health Service, and state and local public health agencies
- Water Pollution Control Federation (WPCF)

2.1.4. *State and Local.* Follow applicable state and local building codes only when they exceed the requirements of the following agencies:

- American Society for Testing and Materials (ASTM)
- National Fire Protection Association (NFPA): Fire and Life Safety
- Occupational Safety & Health Administration (OSHA): 29 CFR 1910 and 1926

5030-1. General

- 1.1. This section provides criteria, requirements, and guidance for civil design and construction plans for BIA school facilities. Civil design shall incorporate accepted engineering practices regarding feasibility, safety, appearance, constructability, and structural integrity.
 - 1.1.1. A complete site boundary and topographic survey depicting major site features planned, such as building orientation, drainage patterns, parking provisions, traffic circulation, provisions for the handicapped, security requirements, etc., shall be developed for the project.
 - 1.1.2. Designs and construction may vary based upon local criteria and/or submittal processes.
- 1.2. **Applicable Publications**. Sustainable design concepts as presented in the following publications should be incorporated to the fullest possible extent:
 - *BIA Site Selection Handbook*
 - U.S. Green Building Council's *LEED-NC Reference Guide for New Construction & Major Renovations*.

Note: Of the potential strategies listed in Credit 6.2 – Stormwater Design: Quality Control, constructed wetlands are disallowed, unless specifically approved by the BIA, due to increased maintenance requirements associated with such installations and the need for continual preservation.

5030-2. Site Criteria**2.1. Geotechnical Investigation**

- 2.1.1. Conduct a complete site geotechnical investigation for all new buildings of more than 2,000 square feet. For smaller buildings, the need for a geotechnical investigation shall be determined by the Contracting Officer on a case-by-case basis.
- 2.1.2. Site grading is to follow the geotechnical investigation report. The Designer of Record shall have grading drawings reviewed by the geotechnical engineer for general adherence to the soils report unless such review is not required by the BIA.
- 2.1.3. Avoid developing sites that are classified as prime farm land, that provide habitat for endangered or threatened species, or that are within 100 feet of any wetland.
- 2.1.4. No facility should be located in a 100-year floodplain, and schools and housing should not be located in a 500-year floodplain. Obtain elevations from the U.S. Army Corps of Engineers or the Federal Emergency Management Agency (FEMA).

5030-3. Site Grading

3.1. General

- 3.1.1. Grade the site to provide positive drainage away from buildings and provide storm drains as needed. Keep waste and borrow of material to a minimum.
- 3.1.2. Consider existing site features affecting grading, such as buildings, streets, curves, walks, fences, watercourses, ponds, elevation of high water, rock outcrops, etc.
- 3.1.3. Provide flood protection for all structures, taking into account flood frequencies as defined in Section 5080, "Storm Drainage."
 - 3.1.3.1. Avoid drainage ponds within the campus area.
- 3.1.4. Consider these principle grading objectives in the early stages of design:
 - Development of attractive, suitable, and economical building sites
 - Provision of safe, convenient, and functional access to all areas for use and maintenance
 - Disposal of surface runoff from the site area without erosion or sedimentation, or its collection as needed for water features, debris basins, or irrigation storage
 - Diversion of surface and subsurface flow away from buildings and pavements to prevent undue saturation of the subgrade, which could damage structures and weaken pavements
 - Preservation of the natural character of the site by minimizing disturbance of existing ground forms and meeting satisfactory ground levels at existing trees to be saved
 - Optimum on-site balance of cut and fill; stockpiling existing topsoil suitable for reuse in landscaping
 - Avoidance of filled areas that will add to the depth or instability of building foundations and pavement subgrades
 - Avoidance of wavy profiles in streets and walks and of steps in walks
 - Avoidance of earth banks requiring costly erosion control measures, except where earth banks are needed in place of costly retaining walls
 - Keeping finished grades as high as practicable where rock will be encountered close to the surface, thus reducing the cost of utility trenching and other excavation and improving growing conditions for vegetation
 - Avoidance of runoff water over roadways to mitigate ice formation

3.2. Finished Floor Elevations

- 3.2.1. Maintain the finished floor elevation of buildings above the finished street grade. Consult with the BIA before specifying any finished floor elevation below the finished street grade.
- 3.2.2. Finished grade elevation adjacent to the building should be a minimum of 12 inches below top of foundation except in areas of access to the building. Buildings should not be in the 100-year or 500-year floodplain. Finished floor elevation of all habitable structures must be built outside of and a minimum of 2 feet above the 500-year floodplain.

3.3. Grade Spot Elevations

- 3.3.1. Establish and show grade spot elevations at key locations on the drawings. Indicate curb or fill requirements and rough estimates of quantities.

3.4. Sidewalks

- 3.4.1. Lay out sidewalks to provide a minimum transverse slope of 1 percent across walks toward the natural drainage. Use a maximum longitudinal slope of 4.9 percent for accessible walks to avoid their classification as ramps.
- 3.4.2. Indicate sidewalk width and locations.

5030-4. Retaining Walls

- 4.1. The following types of retaining walls are permitted:

4.1.1. *Mechanically Stabilized Earth*

- 4.1.1.1. Mechanically stabilized earth (MSE) retaining walls shall consist of a concrete modular block unit, geosynthetic soil reinforcement, backfill, and subsurface drainage.
- 4.1.1.2. The concrete modular block shall be manufactured specifically for use in an MSE wall system.
- 4.1.1.3. Geosynthetic soil reinforcement shall be a geogrid of high-density polyethylene expanded sheet or polyester woven fiber materials, specifically fabricated for use as soil reinforcement.
- 4.1.1.4. MSE retaining walls shall be specified as a performance-specified product. The contractor shall submit construction drawings and design calculations signed and sealed by a registered engineer.

4.1.2. *Reinforced Concrete Retaining Walls*

- 4.1.2.1. Reinforced concrete retaining walls shall consist of a reinforced concrete footing and a reinforced concrete wall designed to resist soil pressures as specified in the geotechnical report.

- 4.1.2.2. Free-draining soil shall be provided on the back surface of retaining walls and water shall be removed from behind the wall by weep holes and a subdrain system.
- 4.1.2.3. Vertical control joints are required at a maximum spacing of 25 feet. Fifty percent of the horizontal reinforcement shall extend through control joints.
- 4.1.2.4. Vertical expansion joints are required at a maximum spacing of 75 feet. Horizontal reinforcement shall not extend through expansion joints.
- 4.1.2.5. Reinforced concrete retaining walls shall be designed by a registered engineer.

4.1.3. Reinforced Masonry Retaining Walls

- 4.1.3.1. Reinforced masonry retaining walls shall consist of a reinforced concrete footing and a reinforced masonry wall designed to resist soil pressures as specified in the geotechnical report.
 - 4.1.3.2. Free-draining soil shall be provided on the back surface of retaining walls, and water shall be removed from behind the wall by weep holes and a subdrain system.
 - 4.1.3.3. Vertical control joints are required at a maximum spacing of 24 feet. Fifty percent of the horizontal reinforcement shall extend through control joints.
 - 4.1.3.4. Vertical expansion joints are required at a maximum spacing of 72 feet. Horizontal reinforcement shall not extend through expansion joints.
 - 4.1.3.5. Reinforced masonry retaining walls shall be designed by a registered engineer.
- 4.1.4. Other types of retaining wall systems are not permitted without prior written approval from the BIA.

5030-5. Areas Adjacent to Buildings

- 5.1. Areas adjacent to buildings that are to be unpaved should be sloped to direct surface water and roof drainage, including snow melt, away from buildings at a minimum of 12 inches in the first 10 feet of horizontal distance. Water should not drain across sidewalks unless approved by the BIA.
- 5.2. Areas to be paved with concrete should have a minimum slope of 0.5 percent and a preferred slope of 1.0 percent.
- 5.3. Areas to receive bituminous pavement should have a minimum slope of 2.0 percent to assure draining without ponding or “birdbaths.”

5030-6. Unoccupied Site Areas

- 6.1. Areas of the site that are to remain unoccupied should have adequate continuous slopes to drain toward watercourses, drainage swales, roadways, and the minimum necessary storm drainage inlets.
- 6.2. Drainage swales or channels should be sized and sloped to accommodate design runoff.
 - 6.2.1. Runoff should be carried under walkways in pipes with diameters of not less than 8 inches or of larger sizes if clogging by debris or grass cuttings is anticipated.
 - 6.2.2. Use swales to intercept water at the top and bottom of banks where large areas are drained. To provide positive drainage, a slope of not less than 2 percent for turfed areas is usually desirable, but more permeable soils may have adequate drainage with a lesser slope.
 - 6.2.3. Turf banks, where required, should be graded to permit the use of gang mowers, providing a maximum slope of 1 vertical in 3 horizontal, but if feasible, a preferred slope of 1 in 4.
- 6.3. The tops and bottoms of all slopes should be gently rounded in a transition curve for optimum appearance and ease of maintenance.

5030-7. Subgrading Procedure

- 7.1. The site area subgrade should be established parallel to the proposed finished grade and at elevations to allow for the thickness of topsoil or other surface.
- 7.2. In fill areas, all topsoil, debris, and other noncompatible materials should be removed; all tree stumps shall be removed or cut out 24 inches below grade.
- 7.3. On sloping areas to be filled, where the original ground is clay, the original ground should be scarified to a depth of 12 inches to provide bond for fill material.
- 7.4. Fill material should be free from debris and have a moisture content and compaction density sufficient to prevent settlement damage to drainage structures, walks, or other planned improvements.

THIS PAGE INTENTIONALLY LEFT BLANK

5040-1. General

- 1.1. This chapter presents guidelines for preparing an erosion and sedimentation control (ESC) plan. An ESC plan is a drawing that should be prepared and issued with the project civil construction documents. The ESC plan should show the proposed grading and storm water drainage system along with the appropriate best management practices (BMPs) necessary to prevent sediment from leaving the project site, due either to storm water or winds.
- 1.2. In addition to the ESC plan, a storm water management plan (SWMP) must be prepared for each project. This report, which must be prepared by the Designer of Record or the contractor, describes appropriate controls and measures (BMPs) to improve water quality by reducing pollutants in storm water discharges. In 1972, Congress passed the Clean Water Act, a comprehensive set of programs that includes the National Pollutant Discharge Elimination System (NPDES). The NPDES regulates the discharge of pollutants into the waters of the United States. Most states implement the NPDES program and locally provide guidance and permitting for compliance with the program. A General Permit for Storm Water Discharges associated with construction activities must be obtained either through the state of the proposed construction project or directly through the U.S. Environmental Protection Agency (EPA). A SWMP is required as part the General Permit for Storm Water Discharges associated with construction activities. The Designer of Record must obtain and follow local guidance, if available, when preparing the SWMP, or use the latest version of the EPA's *Storm Water Management for Construction Activities*, EPA 833-R-92-001.

5040-2. Erosion and Sedimentation Control Plan

- 2.1. The ESC plan should represent the Designer of Record's best estimate of the BMPs that will be required during construction. The SWMP should emphasize the contractor's obligation to regularly inspect and maintain specified BMPs, as well as to routinely implement new BMPs as warranted by various phases of the construction project.
- 2.2. Temporary and permanent erosion control and storm water control measures (BMPs) implemented on the site should be shown on the drawing.
- 2.3. Pre-development and post-development storm water runoff conditions should be considered when preparing the plan.
- 2.4. Type and frequency of maintenance activities should be noted on the plan.
- 2.5. Potential pollution sources anticipated from the site should be identified and addressed by BMPs shown on the plan.

5040-3. Best Management Practices

- 3.1. At a minimum, general practices for preventing storm water pollution are as follows:
 - 3.1.1. Prior to construction, the limits of construction disturbance should be identified. Restoration of previously developed sites should also be noted at this time.
 - 3.1.2. Before clearing and grubbing, sediment barriers shall be installed to intercept sheet flows that might potentially deposit sediment onto public rights-of-way; this includes a barrier at the construction entrance/exit, such as a temporary gravel construction pad.
 - 3.1.3. Wind erosion control methods, such as silt fence, mulching, and soil roughening, should be added if necessary during overlot grading.
 - 3.1.4. Following utility installation, a temporary or perennial grass seed mixture should be applied; if additional anchoring is required, use straw/hay mulch.
 - 3.1.5. In areas to be paved, an early application of gravel shall be completed.
 - 3.1.6. All control measures shall be inspected and repaired as necessary—biweekly in dry periods, and within 24 hours after a rainfall event of 0.5 inches within a 24-hour time period.
 - 3.1.6.1. During prolonged rainfall, daily inspections should take place, and repairs should be implemented as necessary.
 - 3.1.7. Temporary erosion control shall be exercised by minimizing exposed areas and slopes until permanent measures are effective.
 - 3.1.8. If a fueling area is to be designated on-site, it must not pollute storm water; fueling areas shall be a minimum of 100 feet from drainage channels and/or storm sewer systems and be enclosed by a minimum 12-inch-high compacted berm capable of retaining potential spills.
 - 3.1.9. Sediment control measures shall be removed upon final stabilization of lands that contribute runoff waters to the structures.
- 3.2. **Surface Stabilization Techniques**
 - 3.2.1. After construction begins, the soil surface needs to be stabilized to the extent feasible within a 7-day period in areas where disturbance occurred and that may remain unfinished for more than 14 calendar days.
 - 3.2.2. Raindrop impact, flowing water, and wind are forces that cause erosion. Measures that can be taken to reduce this effect are listed in Figure 5040-1.

Figure 5040-1: Time Limits of Land Exposure for Erosion Control Selection

Erosion Control Method	Maximum Allowable Period of Exposure (Months)
Surface roughening	1
Mulching	12
Temporary revegetation	12–24
Permanent revegetation	24 or more
Soil stockpile revegetation	2
Early application of road base	1

- 3.2.3.** Surface roughening, also known as scarification, is done using a chisel or ripping implement to create depressions 2 to 4 inches deep, spaced approximately 4 to 6 inches apart. This method is used to provide temporary stabilization from wind and water erosion where revegetation is not an option due to seasonal conditions.
- 3.2.4.** Mulching is the application of plant residues or other suitable materials to the soil surface, usually clean, weed- and seed-free, long-stemmed grass hay or cereal grain straw, which is anchored; another option is hydraulic mulching, which is applied to steeper slopes, sometimes mixed with wood cellulose and a tackifying agent.
- 3.2.4.1.** Anchoring into the soil should be no more than 2 inches, and the mulch should not be covered with excessive amounts of soil.
- 3.2.4.2.** Cut or fill slopes greater than 6 feet high or steeper than a 3 in 1 slope require the use of erosion control blankets.
- 3.2.5.** Revegetation should be established within one year on all disturbed areas and on soil stockpiles not permanently stabilized by other means. Revegetation is not considered established until it can control soil erosion and survive severe weather conditions.
- 3.2.5.1.** Botanical species to be planted should be compatible with the region to be seeded; seeding rates should also be determined according to the native vegetation in the area.
- 3.2.5.2.** Seedbed preparation is sometimes necessary in areas where exposed soil lacks the necessary nutrients to support vegetation.
- 3.2.5.3.** Soil should be loosened by disking or other means to prepare the site for seeding.
- 3.2.5.4.** Seeds should be planted about 1/4-inch deep, with a maximum depth of 1/2 inch. Distances between furrows should be less than 8 inches.

- 3.2.5.5.** Vegetative stabilization is considered complete when at least 70 percent of the historic cover exists.
- 3.2.6.** Temporary revegetative seeding should be protected with mulch, and the seed should be an annual grass native to the area. This method is required on all disturbed areas that will have been exposed for at least 12 months.
- 3.2.7.** Permanent revegetation requires a perennial grass or grass mix for areas that have been disturbed but where construction will not begin for two or more years; these areas shall be protected by mulch as well.

5050-1. General

- 1.1. This section provides general information on the design and planning of the utility infrastructure for BIA school facilities. Refer to individual utility sections for specific criteria.
- 1.2. All utilities should be kept to minimum interference with one another; provide horizontal and vertical separations, as well as maintenance access that does not violate easement boundaries.
- 1.3. No planting, including trees, or placement of structures shall be allowed within 10 feet of either side of any utility line.
- 1.4. Marker posts shall be provided for any utility structures, including valve boxes, manholes, inflection points, or dead end.
- 1.5. Submitted plans should include profiles showing intersection spacing of all utility infrastructures.

5050-2. Water, Sanitary (Wastewater), and Storm Drainage Systems

- 2.1. Refer to individual relevant sections of this chapter for specific criteria.

5050-3. Fuel Lines

- 3.1. Show the location of gas mains, service lines, liquefied petroleum gas (LPG) tanks, fuel tanks, and other facilities serving and on the property and indicate their capacities.
- 3.2. Refer to Chapter 10, "Mechanical," for fuel line criteria.

5050-4. Electrical, Telephone, and Television Cable

- 4.1. Indicate the location of all such services available to the property, and the size of the main serving each.
- 4.2. Refer to Chapter 11, "Electrical," for full criteria.

5050-5. Minimum Data

- 5.1. Provide information about operating authority, contact persons, size and capacities, and locations of utilities.

5050-6. Distant Utilities

- 6.1. Identify utilities not available to the site, and indicate if the service is available nearby.

5050-7. Surface Water

- 7.1. Indicate bodies of water located near the site and record their elevations. Also note stream and flood levels, as well as recent flood occurrences.
- 7.2. Identify effective 100-year and 500-year flood lines.
- 7.3. Indicate the extent of watershed tributary to the property.

THIS PAGE INTENTIONALLY LEFT BLANK

5060-1. General

1.1. This section provides guidelines for water systems to be used in BIA school facilities, including supply sources, pumping, treatment, storage, and distribution for domestic, industrial, irrigation, and fire protection purposes.

1.2. Applicable Publications

1.2.1. For water system design, distribution, storage, treatment, disinfection, and pumping requirements, refer to:

- American Water Works Association (AWWA) standards
- Ten-State Standards for Water Works
- U.S. Environmental Protection Agency (EPA) regulations and recommended technologies
- The minimum BIA design standards for water use noted in this section

1.3. Wherever available, schools should be connected to municipal water sources (tribal or state-approved city or community water supply) for reliability, quality, and quantity. Other supply sources should be designed by a geohydrologist and/or a professional engineer after completion of field investigations and preparation of a comprehensive report of the source. Water sources include the following:

- Surface (creeks, rivers, and lakes)
- Subsurface (wells)
- Springs

1.4. Consider additional water supply demands associated with tribal housing, future development, and other possible usages.

1.5. Water Consumption

1.5.1. *Average Day Use:* If water consumption data is available from an existing school of similar use and size, those values may be used. At a minimum, the values indicated in Figure 5060-1 shall be used for average day demand.

Figure 5060-1: Average Day Water Consumption*

Type of Facility	Flow (Gallons/Capita/Day) Minimum Water Available	Flow (Gallons/Capita/Day) Adequate Water Available
Day school without cafeteria or locker room	10	15
Day school with cafeteria	20	25
Day school with cafeteria and shower	25	35
Boarding school	80	125

*If potable water is to be used for irrigation, additional flow demand must be considered.

1.5.2. Peaking Factors: Adequate flow capacity and pressure is to be provided based on peak hour demand or peak day plus fire flow demand, whichever is greater. Use the peaking factors (PFs) shown in Figure 5060-2 to calculate minimum flow demands under the specified conditions.

Figure 5060-2: Peaking Factors – Minimum (Average Day x PF)

Average Day	Peak Day	Peak Hour
1.0	3.0	5.0

5060-2. Water Source Criteria (Non-Municipal)

- 2.1. Water sources must be examined for expected safe yields; the watershed or source location, noting existing or potential sources of contamination; relevant geologic conditions; expected water quality; required water storage capacities and elevations; and pumping system requirements. Water quality is to be analyzed and treatment needs identified for each water source.
- 2.2. When municipal water is not available, wells are the preferred water supply source; they may be deep aquifer (greater than 100 feet), or alluvial (less than 100 feet). Alluvial wells must be free of microscopic particulates.
 - 2.2.1. All waters post-treatment must comply with all Federal Safe Drinking Water Act requirements.
 - 2.2.2. Wells shall not be constructed within the 100-year floodplain.
 - 2.2.3. Wells shall be constructed with a sanitary seal.
 - 2.2.4. Wells must be vented and covered with a 24-mesh corrosion-resistant screen.
 - 2.2.5. Wells shall have a 4-foot diameter concrete pad poured around the well casing.

- 2.2.6. If accommodations must be made in colder environments, wells shall have a pitless adapter. This allows for flow into the building despite the depth of frozen soil.
- 2.2.7. Well vaults are not permitted.
- 2.2.8. Well pumps and depth settings shall be specified by a groundwater hydrogeologist. Well borings shall be sampled. Sediment samples from anticipated production zones are to be analyzed for parameters to assist with well design. Well design shall identify casing size and lengths, grouted intervals, well screen slot size(s), screen length, filter pack requirements, centralizers, and testing requirements for well construction.

5060-3. Well-Pumping Units

- 3.1. Design well-pumping equipment to meet the required well capacity based on test pump data or on the specific requirements of the project, whichever is less.
- 3.2. Provide lightning arrestors as part of well controls. Pump controls should be electrode actuators in the water storage tank, where feasible; otherwise, use manual or pressure controls.
- 3.3. Install electrode shutoffs in all wells to prevent over-pumping of the well and damage to the pumping unit. Refer to Chapter 11 for electrical standards.
- 3.4. Well pump houses should be sized adequately for easy equipment operation and maintenance. Use space heaters or other approved methods to prevent pump house piping from freezing.
- 3.5. Pressure gauges, check valves, gate valves, meters, valved test pipes, and other appurtenances necessary on the well discharge line should be provided.
- 3.6. Motors should drive the pumps under the service required without exceeding 85 percent of the specified rating, in accordance with the National Electrical Manufacturer's Association Motors and Generators (NEMA MG1) standard. Refer to Hydraulic Institute standards for motor type discussions.

3.7. Flow Meters

- 3.7.1. Pumped water is metered for the following reasons: to calculate distribution system losses, the difference between meter reading total and supply total; to monitor pump efficiency; and to determine gross billings for water supplied. Provide 10 pipe diameters upstream and 5 pipe diameters downstream in straight piping to assess meter accuracy.
- 3.7.2. The flow meters most common in water pumping installations are, in order of preference, magnetic meters, propeller meters, turbine meters, and differential pressure meters.
 - 3.7.2.1. Magnetic meters are preferred based on accuracy and range of flow, including typical ranges of 10 to 1 and plus or minus 0.5 to 1.0 percent accuracy.

- 3.7.2.2. Propeller meters, with an accuracy of plus or minus 2 percent over a 10 to 1 range, are next in order of preference. Such meters should meet AWWA C704 standards. Propeller meters have a lower initial cost because of their small size and simple design, and have historically proven effective.
- 3.7.2.3. Turbine meters are typically used for systems with a small range of flow. These meters must meet the standards of AWWA C701.
- 3.7.2.4. Other meters can be considered based on specific site conditions. Differential pressure meters may be considered in circumstances that can be justified in writing by the Designer of Record; however, differential pressure meters are not as accurate as magnetic meters.

3.8. Springs

- 3.8.1. Springs shall not be developed within the 100-year floodplain.
- 3.8.2. Springs, if not fed by surface water, will normally need only disinfection for treatment prior to use, whereas surface waters require complete treatment prior to use.
- 3.8.3. Evaluate the reliability of future flow capacities of springs prior to excluding other water source options.

3.9. Surface Water

- 3.9.1. All surface water used for potable water shall receive complete treatment before use.
- 3.9.2. The watersheds of surface water sources shall be protected from uses that could cause them harm.
- 3.9.3. Surface water intakes, direct diversion infiltration galleries, or subsurface diversion shall be designed to prevent possible vandalism.
- 3.9.4. Surface water sources intake structures shall be designed to shut down due to upstream conditions such as high turbidity, hazardous spills, etc.

5060-4. Water Distribution

- 4.1. The water distribution system comprises the network of piping throughout building areas and other areas of water use or fire demand, including hydrants, valves, and other appurtenances used to supply water for domestic and fire fighting purposes.
- 4.2. Pipe Layout
 - 4.2.1. The sanitary sewer pipe should be below the water main lines with an 18-inch difference between the invert of the water main and the crown of the sewer pipe. Under unusual conditions, should the sewer pass over the water main, the spacing shall remain 18 inches; if vertical separation is less than 18 inches, provide structural support for the sewer pipe.

- 4.2.2. The sanitary sewer shall be one continuous length of watertight pipe 20 feet long centered on a water main. Joints are to be encased in concrete a minimum of 6 inches thick and should extend 6 inches on either side of the joint. As an alternative, sewer pipe may be fully encased in 6 inches of concrete around the pipe and extend 10 feet horizontally on either side of the water main.
- 4.2.3. Thrust restraint calculations must be performed. The Designer of Record shall include thrust blocks for all bends and dead ends, as well as pipe joint restraint.
- 4.2.4. The preferred location of water mains is parallel to roadway right-of-way or curb line 10 feet outside of pavement edges. Prior to locating water mains within the roadway, a benefit versus long-term maintenance cost analysis must be submitted to and approved by the BIA. See further discussion in Paragraph 4.3.
- 4.2.5. The BIA will consider topography in relation to layout and long-term maintenance when water mains are connected to existing systems.
- 4.3. The alignment, depth, flow direction, and size of all waterlines, sanitary sewer, storm drain, and steam lines should be located and plotted. Also indicate location, elevation, and depth of manholes, catch basins, and water valves (horizontal and vertical).
- 4.4. If the BIA approves the location of water mains within the roadway, water mains should be a minimum of 4 feet from the outside of the pipe to the lip of the curb in the middle of the roadway section. If possible, water shall be 10 feet north or east of the centerline.
 - 4.4.1. Elevations should be indicated to the nearest 0.01 foot.
- 4.5. **Tracer Wire.** Tracer wires for water mains shall be installed with all plastic pipes.
 - 4.5.1. The wire shall be plastic-covered #12 AWG (4-square-millimeter) type THWN taped to the top of the waterline with 10-millimeter tape. Plastic cover for waterline tracer wire shall be blue, and for reclaimed wastewater (graywater), it shall be purple.
 - 4.5.2. A 5-pound magnesium anode shall be installed for each 1,000 linear feet of tracer wire, or at each end of the project, near the curb next to a water service. It shall be placed in a separate cast-iron box a minimum of 1 foot from the water service.
 - 4.5.3. The tracer wire connection station shall be installed at each fire hydrant and street intersection, for each 500 linear feet, and at each end of the project.
 - 4.5.4. Tracer wire shall be tested prior to paving and owner acceptance to show that all water/reclaimed wastewater mains can be located in this manner; the owner's representative shall witness the tests.

- 4.5.5. All information necessary for the wire, anode, and connection station locations shall be provided to the owner.
- 4.5.6. All tracer wire splices shall be Bundy KS17, 12 AWG copper split connectors.
- 4.5.7. The construction plans should show all tracer wire, anodes, and connection stations.
- 4.5.8. Six-inch-wide, 4-mil-thick plastic warning tape shall be placed 12 to 24 inches below finished grade above mains; blue for water mains, purple for reclaimed wastewater mains, and green for sewer mains. The tape shall be printed at least every 36 inches with “BURIED WATERLINE BELOW,” “BURIED RECLAIMED WASTEWATER LINE BELOW,” and “BURIED SEWER BELOW” for each respective pipe.
- 4.6. **Pipe.** Main waterline pipe diameter shall be a minimum of 8 inches. Design a looped water system where practical to maintain water quality and provide appropriate fire suppression. Polyvinyl chloride (PVC) piping is the preferred material unless the Designer of Record can write a supporting document of explanation for use of an alternate material. Possible supporting conditions may include thermal or other pertinent soil conditions.
 - 4.6.1. PVC pipe must conform to the AWWA C900 standard and is used in situations requiring a 4-inch minimum diameter.
 - 4.6.2. Ductile iron pipe (DIP) must conform to AWWA C151 standards, Class 52, and is used for 3-inch and larger diameters.
 - 4.6.3. Service lines shall be copper piping and must conform to ASTM B88 and AWWA C800. Copper pipe should be used for 2-inch or smaller diameter pipe, and should be Type K, water tube, seamless, annealed temper, with flared connections. Water service lines should extend to all new buildings from existing and/or new water distribution mains. The pressure loss through the service line should not exceed 10 pounds per square inch (psi) at the peak building demand, including head losses through the water meter.
 - 4.6.4. Fire hydrant laterals shall be DIP fully restrained between the fire hydrant and main.
 - 4.6.5. The minimum waterline cover shall be 3 feet, or to a depth equivalent to the maximum frost penetration plus 12 inches, whichever is greater. Maximum water main depth should not exceed 4 feet deeper than minimum required depths.
 - 4.6.6. All water distribution systems should be designed according to the pressures noted in Figure 5060-3.

Figure 5060-3: Operating Pressures

Operating System Pressure	Under All Flow Conditions (Including Fire Flows)	At Highest Building Floor Level
Maximum	80 psi	–
Normal	60 psi	–
Minimum	20 psi – during a fire	40 psi

4.7. Valves

- 4.7.1. Distribution system valve types include: gate valves (12 inches and smaller), butterfly valves (14 inches and larger), and ball valves for isolation. Specialty valves may also include pressure-reducing valves, check valves, blow-off valves, and relief valves.
- 4.7.2. The system should have valves that allow the sections to be isolated without total system shutdown. Isolation valves for fire lines shall include a post indicator.
- 4.7.3. Locate isolation valves no more than 500 feet apart in areas with BIA occupied facilities, and no more than one block or 800 feet apart in other facility installations. Valves 3 inches to 12 inches shall be resilient-seated nonrising stem gate valves conforming to AWWA C509. Valves larger than 12 inches shall be rubber-seated leaktight butterfly valves conforming to AWWA C504.

5060-5. Water Storage

5.1. Types (for Schools Not Connected to Municipal Systems)

- 5.1.1. **Concrete on Grade.** Concrete foundations, concrete walls, and concrete lids shall be designed and detailed in accordance with American Concrete Institute (ACI) 350 *Code Requirements for Environmental Engineering Concrete Structures* and ASCE 7 *Minimum Design Loads for Buildings and Other Structures*.
- 5.1.1.1. Concrete shall have a minimum compressive strength of 4,000 pounds per square inch, a maximum water-cement ratio of 0.45, and a maximum chloride ion limit of 0.10 percent of the weight of the cement.
- 5.1.1.2. Concrete tanks shall be tested in accordance with ACI 350.1 *Tightness Testing of Environmental Engineering Concrete Structures*.
- 5.1.1.3. The inside surface of concrete tanks shall have a smooth formed finish, as defined by ACI 301 *Specifications for Structural Concrete*.
- 5.1.2. **Concrete Below Grade.** Same as for concrete on grade (see above).

5.1.3. *Steel on Grade.* Foundations for steel tanks on grade shall be designed in accordance with the guidelines in Chapter 9, “Structural,” for the anticipated design loads, as provided by the tank manufacturer. Where a concrete slab serves as the bottom of the tank, the slab shall conform to requirements for concrete tanks.

5.1.4. *Steel Elevated (Four-Legged/Pedestal).* Foundations for elevated steel tanks shall be designed in accordance with the guidelines in Chapter 9, “Structural,” for the anticipated design loads as provided by the elevated tank manufacturer.

5.2. Sizing and Design Requirements

5.2.1. Tanks shall have a minimum capacity of 60,000 gallons for fire fighting at 500 gallons per minute for a 2-hour duration, plus three days average water usage.

5.2.2. For ease of maintenance, multiple tanks are preferred. For smaller systems, a single tank is acceptable.

5.2.3. Provide additional fire water storage for fire flows that exceed 500 gallons per minute based on a 2-hour duration.

5.2.4. Tanks shall be located above the 500-year floodplain.

5.2.5. All tank structures shall have visible overflow discharge piping.

5.2.6. All tank structures shall be vented, with vents having a 24-mesh copper screen.

5.2.7. Finished water tanks shall be disinfected in accordance with AWWA C652 and tested to demonstrate bacterial safety prior to use.

5.2.8. Cathodic protection devices must be provided on all steel-structured water tanks. Provide cathodic protection calculations indicating the requirements necessary.

5.3. Small Capacity Water Storage

5.3.1. *Hydropneumatic Pressure Systems.* In schools with small enrollments where demand does not justify major storage, hydropneumatic systems may be used.

5.3.2. The system must operate at a range of 50 to 70 psi.

5060-6. Water Treatment

- 6.1. All water from non-municipal sources shall receive treatment prior to use. The type of treatment required is determined by the complete chemical and bacteriological raw water analysis. The suggested treatment capacity is the peak day demand for the system.
- 6.2. All required treatment must comply with state and federal Clean Water Act criteria and regulations.
- 6.3. Water from groundwater sources (nonalluvial) normally requires only disinfection treatment prior to potable use.
- 6.4. Alluvial wells require a microscopic particulate analysis prior to determining the type of treatment required. Well water with no particulate count will normally require only disinfection. Well water with particulates will also require filtration (pressure).

6.5. Filtration**6.5.1.** Filtration types to be considered are:

- Cartridge/bag filtration. This system minimizes maintenance and is preferred.
- Rapid sand, gravity, or pressure.
- Slow sand filtration.

6.5.2. All filtration systems shall have two units, and final design of water treatment facilities shall consider the following criteria for filtration:

- Hydraulic loading rates
- Filter media
- Surface and subsurface wash
- Backwash
- Sampling taps
- Continuous turbidity recording devices

6.6. Disinfection

- 6.6.1. All non-municipal water furnished to the public shall be disinfected unless a proven well has a waiver of disinfection from the state regulatory authority based solely upon historical records.
- 6.6.2. Where surface waters are used, raw water, applied water, and finished water should be disinfected with chlorine.
- 6.6.3. Chlorination may be accomplished with:
 - Sodium hypochlorite solution feed. This is the preferred method unless a written report identifies specific reasons why the system is

not applicable. The report must be provided by the BIA. Characteristics such as flow volume will be considered.

- Gas chlorine.
- 6.6.4.** Gas chlorine should not be used in systems using less than 0.10 million gallons per day (mgd).
- 6.6.5.** Special design criteria apply when disinfecting with chlorine gas. For the criteria to be followed, contact the state environmental office that has jurisdiction. All safety provisions shall be applied, including but not limited to storage chlorination rooms (leaktight, exhaust, wash stations, gas masks, etc.).
- 6.6.6.** After chlorination, detention time shall be at least 30 minutes prior to reaching the first tap.
- 6.6.7.** The design shall include a standby chlorination unit.
- 6.6.8.** Tablet type chlorine feeders are not acceptable.
- 6.6.9.** The minimum residual chlorine concentration reaching the distribution system shall not be less than 0.2 of a milligram per liter.
- 6.6.10.** Ultraviolet light disinfection is not acceptable.

5060-7. Pumps

- 7.1.** Type of station, intake, design capacities, and operating heads (maximum, minimum, submergence—to produce a net positive suction head) are the main factors in selecting pump types. There are two main types of pumps used for domestic water: vertical turbine pumps and centrifugal pumps.
- 7.2.** Pump station design shall meet the requirements of the Hydraulic Institute and standard requirements of the NFPA.

7.3. Criteria for Pump Type Selection

7.3.1. *Pump Capacity*

- 7.3.1.1.** Attempt to meet peak demands with two or three duty pumps. Accommodate normal flow demand with one pump. An effort should be made to limit the number of pump sizes. Consider low-flow issues related to the need for a jockey pump or recirculation pump.

7.3.2. *Pump Operating Conditions*

- 7.3.2.1.** Consider either constant speed or variable speed pumps to provide for anticipated demands. Long-term maintenance of the system is paramount to this decision; therefore, constant speed pumps are the preferred system.
- 7.3.2.2.** Because it will eliminate many operational problems, a net positive suction head (NPSH) is required for all pumps.

- 7.3.2.3. To mitigate cavitation issues, select a pump with a pump curve that is as steep as possible.
- 7.3.2.4. Select a pump with as low a horsepower as possible that still maintains a non-overloading motor.
- 7.3.2.5. To conserve energy and extend the life of the system, select a pump with as low an rpm as possible.
- 7.3.2.6. Verify proper pump selection by comparing the pump curve(s) to the system head curve(s).
- 7.3.2.7. Other pump selection considerations should include client preference, locality, budget, maintenance, and schedule (pump delivery).
- 7.3.2.8. Determine the extent of automation, control, and telemetry needed for the pump system.
- 7.3.2.9. All pump systems must have a standby power source unless the Designer of Record provides documentation with compelling reasons why backup power is not possible. The BIA must approve any non-use of backup power.

7.3.3. *Pump Station Site Selection*

- 7.3.3.1. A pump site must not be subject to flooding conditions or be located within a 500-year floodplain.
- 7.3.3.2. Identify the locations of the water supply and the pump station. Consider topography in relation to layout and long-term maintenance. Above-ground pump stations are preferred. If an above-ground location is not possible, design for a nonconfined-space, below-grade configuration.
- 7.3.3.3. Site selection must consider noise abatement for all aspects of the water system. Decibel levels exceeding existing conditions without the written consent of the BIA will not be allowed.

7.4. Pump Applications

- 7.4.1. *Booster Pumps.* These increase the pressure in the pipeline to desired levels, where necessary, and may be located above ground or below ground. Due to varied topography, they are usually located remotely from the main pump station.
- 7.4.2. *High Lift Pumps.* These pump directly into transmission lines and distribution systems.

7.5. Pump Station Piping

- 7.5.1. Piping within a pump station may consist of properly restrained ductile iron, PVC (nonsolvent welded), and steel pipe meeting ASTM A312 for 3/4-inch through 30-inch.

- 7.5.2. Fittings for 2-inch and smaller pipe should be threaded and should conform to ASTM A403 and ANSI B16.3. Larger fittings should be butt welded, grooved end, or flanged and should conform to ASTM A403 or A774 and ANSI B16.9.
- 7.5.3. Thrust restraint, including pipe supports, hangers, concrete base elbow support, steel pipe support, or similar thrust restraint, must be properly sized, spaced, and located to resist pipe movement.
- 7.5.4. Valving should be flanged and have operating mechanisms to allow for easy indoor opening and closing (hand wheel, chain wheel).

5060-8. Fire Protection

- 8.1. Distribution lines and fire hydrants should be addressed upon completion of the hydraulic analysis, and should meet the requirements of the BIA installations.

8.2. Applicable Criteria

- NFPA 20 Standard for the Installation of Stationary Fire Pumps for Fire Protection
- NFPA 24 Installation of Private Fire Service Mains and Their Appurtenances
- NFPA 5000: 55 Standpipe and Hose Systems
- Applicable state criteria

- 8.2.1. Comply with NFPA 13 Ordinary Hazard classification occupancy requirements when the installation is located outside a municipal/city service area, and specify bypass valves and flow metering devices to prevent the restriction of fire flows. All sprinkler service lines 3 inches and larger should be equipped with post indicators on the service line shutoff valves.

- 8.2.2. Meet state fire marshal or Insurance Services Office requirements when the facility is located in a municipal/city service area and such requirements exceed BIA requirements.

8.3. Fire Hydrants

- 8.3.1. Hydrants shall have 5.25-inch diameter barrels, minimum, with two 2.5-inch hose connections and one 4.5-inch pumper connection.
- 8.3.2. Hydrants shall be designed for 150 psi working pressure or 300 psi hydrostatic pressure, and not less than 20 psi residual pressure.
- 8.3.3. Working parts shall be bronze and hose threads shall conform to the National Pipe Thread (NPT) standards. Exceptions are only in municipalities/cities where hydrants are designed for their own firefighting equipment.

- 8.3.4.** Dry barrel, traffic breakable model fire hydrants shall be used, and shall conform to AWWA C502 requirements.
- 8.3.5.** Maximum spacing between fire hydrants shall be 400 feet; however, this spacing applies to systems with large line sizes and high pressures. Normally, hydrants will be spaced at 325 to 350 feet. The minimum distance between any fire hydrant and a building shall be 50 feet. The maximum distance to a fire hydrant from any point on the building perimeter shall not exceed 250 feet.
- 8.3.6.** All hydrant leads shall be a minimum of 6 inches in diameter. A 6-inch gate valve box shall be installed on each hydrant lead upstream of each fire hydrant.
- 8.3.7.** Color code fire hydrants by flow capacities as shown in Figure 5060-4:

Figure 5060-4: Fire Hydrant Color Coding

Hydrant Flow (Gallons/Minute)	Color
750 or greater	Chrome yellow
50 to 750	Green
Less than 50	Red

THIS PAGE INTENTIONALLY LEFT BLANK

5070-1. General

- 1.1. This section shall be used as a guideline for the design and construction of all wastewater systems in BIA school facilities, whether they are connected to a central (municipal) collected system or not. The preferred sanitary sewer system is one connected to a central/municipal system. If a municipal system is not available within a reasonable distance, alternative treatments are to be evaluated.
- 1.2. Wastewater systems include collection, pumping, treatment, and disposal of domestic and industrial wastes.
- 1.3. Designs and construction of wastewater systems may vary based upon local criteria and/or submittal processes.
- 1.4. **Applicable Publications**
 - 1.4.1. All design and construction shall meet EPA regulations and more stringent state water quality discharge standards.
 - 1.4.2. All design and construction shall conform to the American Society of Civil Engineers (ASCE) Manuals and Reports on Engineering Practice No. 37, Design and Construction of Sanitary and Storm Sewers.

5070-2. Wastewater Flow and Waste Loads**2.1. Determination of Loads**

- 2.1.1. Flows to wastewater treatment facilities shall be calculated as 90 percent of domestic potable water usage flows meeting the criteria listed in Section 5060, Figure 5060-1.
- 2.1.2. For purposes of the design of the treatment facility, peak daily flows shall be four times the average daily flow.
- 2.1.3. Sewer systems, trunk lines, and outfall lines should be designed to service the ultimate density of the tributary area.

5070-3. Treatment System Selection and Analysis**3.1. Selection**

- 3.1.1. Wastewater treatment shall conform to applicable state criteria. Designs shall be based on meeting the requirements of a National Pollutant Discharge Elimination System (NPDES) discharge permit, as provided by the state or the EPA.
- 3.1.2. Where two or more alternatives are available and feasible for providing public wastewater facilities, base all new designs on the most economical plan consistent with the applicable criteria. The BIA prefers that all treatment systems be lagoons, unless specifically stated or approved otherwise.

3.2. Aerated and Facultative Lagoons

- 3.2.1.** Wastewater lagoons shall be as far as practicable from the nearest residence or building, a minimum of 1,000 feet, with a preferable minimum distance of 1,500 feet.
- 3.2.2.** Nonaerated lagoon systems shall have a minimum of two cells and shall be designed to operate in both series and in parallel formation.
- 3.2.3.** Valving shall be provided so that flow can be discharged directly to or from either cell.
- 3.2.4.** Cells should be shaped to minimize short-circuiting. Rectangular ponds with a length not exceeding three times the width are recommended. Site geometry should be considered in configuration design.
- 3.2.5.** Interior sides shall be sloped no greater than 3 to 1 and all interior corners shall be rounded.
- 3.2.6.** Nonaerated lagoons shall have a minimum freeboard above the high-water line of 3 feet; aerated lagoons shall have a minimum freeboard of 2 feet.
- 3.2.7.** Lagoon embankments shall be constructed of impervious material and compacted to greater than 95 percent Proctor.
- 3.2.8.** Lagoons shall be constructed so allowable seepage out of the bottom will not exceed 1/32 of an inch per day (10^{-6} cm/s).
- 3.2.9.** Where seepage from lagoons will exceed 1/32 of an inch per day, lagoons shall be lined with bentonite, native clay material, asphalt, or synthetic liners. Failure to seal lagoons will require obtaining a water discharge permit.

Figure 5070-1: Facultative Lagoon Criteria, Disposal Method

	Continuous Discharge	Controlled Discharge	Land Application	Total Retention
Primary Cells				
Minimum number ¹	2	2	1	1
BOD ₅ loading (pounds/acre/day)	15–35	15–35	15–35	15–35
Normal operating range (feet)	4–5	4–5	4–5	4–5
Max. depth w/o aeration (feet)	6	6	6	6
Detention time ² (days)	40–80	40–80	40–80	40–80
Max. seepage rate ³ (inches/year)	6	6	6	6
Secondary or Storage Cells				
Minimum number	1	1	1	1
Normal operating range (feet)	4–5	4–5	4–5	4–5
Max. depth w/o aeration (feet)	6	6	6	6
Minimum depth ⁴ (feet)	2	2	2	2
Max. seepage rate ³ (inches/year)	15	15	15	15
Overall System				
Max. BOD ₅ loading (pounds/acre/day)	30	30	30	30
Minimum detention time (days)	180	180	90–120	Total retention ⁶
Emergency or winter storage (days)	N/A	N/A	60–150 ^{5,6}	Total retention ⁶

- Notes:**
1. All primary cells shall be approximately equal in size.
 2. All detention times are based on volume between the 2-foot level and the maximum design depth.
 3. Unless groundwater conditions dictate a lower seepage rate; for example, because of contamination of a drinking water supply.
 4. Minimum depth represents the lowest operating level for temporary operation or maintenance purposes only. This level is not to be considered or utilized as a normal operating depth.
 5. Shorter time periods for infiltration/percolation disposal and longer time periods for irrigation.
 6. A month-by-month water balance must be submitted with each land application or total retention disposal plan.

Figure 5070-2: Aerated Lagoon Criteria, Disposal Method

	Continuous Discharge	Controlled Discharge	Land Application	Total Retention
Minimum number of aerated cells ¹	2	2	1-2 ²	1
Recommended mode of aeration ³	Tapered	Tapered	Equal	N/A
Minimum design oxygen requirements (pounds O ₂ /pound BOD ₅ removed ⁴) depth (feet)	2.0	2.0	2.0	N/A
Minimum dissolved oxygen level (mg/L) ⁵	2.0	2.0	2.0	2.0
Depth (feet)	6-15	6-15	6-15	6-15
BOD ₅ loading on aerated cells (pound/acre/day)	30-100	30-100	30-100	30-100
Minimum detention time under aeration (days) ⁶	20	20	15	15
Emergency storage for infiltration/percolation (days)	N/A	N/A	30-90	N/A
Winter storage for irrigation or complete retention	N/A	N/A	See ⁷	See ⁷

- Notes:**
1. Outlet area of all final cells must have a quiescent zone to settle solids.
 2. One aeration cell if large storage cell is proposed. Two aeration cells if infiltration/percolation is proposed.
 3. If first cell is out of service, sufficient oxygen must be dispersed in remaining cells to keep cells aerobic.
 4. Oxygen supplied must be sufficient to meet the organic, nitrogenous, benthic, and algal demands in the pond.
 5. Measured 2 feet below the surface of the pond.
 6. Detention time must be sufficient to provide adequate BOD reduction to meet waste discharge requirements. Volume is calculated from 2 feet from the bottom to maximum depth. Time not inclusive of quiescent zone; waste load and climatic conditions may require more stringent criteria.
 7. A month-by-month water balance must be submitted with each land application or total retention disposal plan to determine winter storage.

5070-4. Wastewater Systems Appurtenances

- 4.1. All lagoons shall have an influent manhole so that influent flow measuring devices can be installed.
- 4.2. It is recommended that there be a hand-cleaned or mechanically cleaned bar screen on the upstream side of the influent manhole.
- 4.3. The waste stabilization pond (for nonaerated lagoons) shall have a maximum water depth of 5 feet.
- 4.4. The area of the lagoons will be governed by both organic and hydraulic loading limits. The total lagoon system shall be capable of holding the design flow for 180 days, including water losses and evaporation.
 - 4.4.1. Design for no more than 0.5 pounds of biochemical oxygen demand (BOD) per 1,000 square feet of water surface area per day.
 - 4.4.2. Fencing is required around all lagoons and must consist of chain-link fencing with a 3-strand barbed wire on top for an overall height of 6 feet. A 12-foot access gate and a 3-foot man gate are required.
- 4.5. No wastewater effluent shall be sprayed from a wastewater system upon a public street. A minimum setback of 25 feet shall be maintained from any surface application area to an adjoining public street, public property, or another person's property.
- 4.6. Lagoons (aerated or nonaerated) that discharge to state water shall be designed to a minimum of 80 percent BOD removal. Nondischarge lagoons are recommended wherever possible.
- 4.7. Use of wetlands for discharge is a possible disposal for a treatment process. However, due to maintenance considerations, this is not a preferred discharge method unless approved by the BIA.

5070-5. Alternative Treatment Facilities

- 5.1. Design of individual on-site treatment/disposal facilities should conform to the applicable criteria as set forth by the governing state Public Health Department and to local board of health requirements. Use of individual on-site treatment/disposal facilities is not a preferred alternative and should be considered only for small system design with approval of the BIA.
- 5.2. Packaged sanitary treatment systems may be an option, but are not recommended unless specifically approved by the BIA.
- 5.3. **Septic Tank/Leach Field Systems Design Criteria (First Stage Treatment Unit)**
 - 5.3.1. The inlet invert shall be at least 3 inches higher than the outlet invert.

- 5.3.2. The outlet tee or baffle shall extend above the surface of the liquid to within 1 inch of the underside of the tank top and shall extend at least 14 inches below the outlet invert.
- 5.3.3. The distance from the outlet invert to the underside of the tank top shall be at least 10 inches.
- 5.3.4. A 1,250-gallon, two-compartment tank is the minimum size allowable.
- 5.3.4.1. The transfer of liquid from the first compartment to the second shall be made at a liquid depth of at least 14 inches below the outlet invert, but not in the sludge zone.
- 5.3.4.2. At least one access no less than 24 inches across shall be provided in each tank compartment.
- 5.3.5. Septic tank leach fields shall be located no closer than 200 feet from any potable water source.
- 5.3.6. A septic tank manhole opening cover shall be no deeper than 8 inches below the finished grade, and made of materials resistant to degradation from moisture or sewer grades.
- 5.3.7. The replaced leach field area shall be located on-site in the original design unless an alternative site was originally anticipated and sufficient area is available.
- 5.3.8. *Aerobic Sewage Treatment System Within Septic Systems*
- 5.3.8.1. This shall prevent excessive short-circuiting flow, and deposition and buildup of solids in the aeration compartment, as well as allow for intimate mixing of applied sewage, return solids, and applied air.
- 5.3.8.2. Aeration methods are either mechanical aeration or diffused air, or a combination of both.

5.4. Second Stage or Later Treatment Unit

5.4.1. *Soil Absorption System (General)*

- 5.4.1.1. Calculate the minimum absorption area based upon the amount of suitable soil and the capacity of the soil to absorb liquids (determined by a percolation test), design criteria, and construction standards for this type of absorption system.
- 5.4.1.2. Soil absorption systems are not permitted in areas exhibiting any of the following conditions, unless designed by a registered professional engineer and approved by the local board of health (if regulations of the local board of health for such systems treat exclusively domestic wastes):
- Where the soil percolation rate is slower than 1 inch in 60 minutes or faster than 1 inch in 5 minutes; if the percolation

rate is faster than 1 inch in 5 minutes in soils of sandy texture, soil treatment may slow the percolation.

- Where the maximum seasonal level of the groundwater table is less than 4 feet below the bottom of the proposed absorption system.
- Where bedrock exists less than 4 feet below the bottom of the proposed absorption system.

5.4.1.3. Suitable soil requirements may be met by soil building or replacement.

5.4.2. Absorption Area Formulas

5.4.2.1. The minimum absorption area for an individual sewage disposal system can be calculated using the following formula. The minimum “t” value is 5.

$$A = \frac{Q}{5} \sqrt{t}$$

where: A = minimum absorption area (square feet)
 Q = design flow of sewage (gallons per day)
 t = percolation rate (minutes per inch)

5.4.2.2. Long-term acceptance rates (LTARs): The minimum absorption area may also be computed as a function of the design flow and the LTAR according to the formula below. (LTAR values are listed in Figure 5070-3):

$$A = \frac{Q}{L * T * A * R}$$

Figure 5070-3: LTARs for Wastewater Soil Absorption Systems

Percolation Rate (Minutes/Inch)	Typical Soil Textures	Maximum Loading Rate (Gallons/Square Feet/Day)
<5**	Gravel**	Not suitable
1–5	Coarse to medium sand	1.30
6–10	Fine sand to loamy sand	1.20
11–20	Sandy loam to loam	0.72
21–30	Loam	0.50
31–40	Loam to silty loam*	0.40
41–60	Clay loam to clay*	0.30
Over 60**	Silty clay loam/silty clay	0.20

*Soils without highly expansive clays

**Design by registered professional engineer required

Note: Percolation rates faster than 5 minutes per inch require a professional engineer design.

5.4.3. Allowable Absorption Area Reductions and Increases

- 5.4.3.1. Adjustments must meet local health department criteria.
- 5.4.3.2. Maximum daily flow reduction for design purposes is 20 percent; lower values may be determined by the local health officer or his/her agent.
- 5.4.3.3. Reduction in the soil absorption area may be allowed for gravelless soil absorption systems with approval of the health department and at the discretion of the local health officer or his/her agent.
- 5.4.3.4. The absorption area should be increased by an additional 20 percent if wastes from a garbage grinder are discharged into the system; add an additional 40 percent if wastes from an automatic clothes washing machine are discharged into the system.
- 5.4.3.5. The maximum reduction in size of absorption area from all combined alternatives is 50 percent of the standard required soil absorption area.

5.4.4. **Alternating Systems.** The use of alternating systems is preferred. In alternating systems, the diversion mechanism shall be readily accessible from the finished grade and shall be switched annually. Reductions in absorption field area are not applicable to alternating systems; flow reductions may be taken where applicable.

5.4.5. Dosing may be used in conjunction with soil absorption systems, and the frequency can be calculated using the values in Figure 5070-4.

Figure 5070-4: Suggested Dosing Frequencies for Soil Textures

Soil Texture	Dosing Frequency
Sand	4 doses/day
Sandy loam	1 dose/day
Loam	Frequency not critical*
Silty loam	1 dose/day
Silty clay loam	1 dose/day
Clay	Frequency not critical*

* Long-term resting provided by alternating fields is desirable and recommended in these soils.

5.4.6. Absorption Area Construction

- 5.4.6.1. An absorption trench or seepage bed shall provide the required absorption area. The bottom of the trench or bed and distribution lines shall be level.
- 5.4.6.2. The separating distance between soil absorption systems shall be a minimum of 6 feet sidewall to sidewall. The separating distance between parallel distribution lines in a seepage bed shall not exceed 6 feet, and a distribution line shall be located within 3 feet of each sidewall of the seepage bed.
- 5.4.6.3. Perforated distribution pipe shall be placed the entire length of the trench or bed, surrounded by clean graded gravel, rock, or material of equal efficiency, which may range in size from 1/2 inch to 2½ inches and shall be placed from at least 2 inches above the top of the distribution pipe to at least 6 inches below the bottom of the distribution pipe. Tile or open joint pipe shall not be used.
- 5.4.6.4. Pipe for gravity distribution shall be no less than 3 inches in diameter and preferably less than 100 feet in length. The terminal ends of lines shall be capped unless looped or air vented.
- 5.4.6.5. The top of the placed gravel or other material used shall be covered with a layer of hay, straw, or similar pervious material. An impervious covering shall not be used.
- 5.4.6.6. A final cover of soil at least 10 inches deep, suitable for vegetation, shall be placed from the top of the hay, straw, or similar pervious material to the finished surface grade of an absorption trench or seepage bed. The final cover shall be graded to deflect runoff water away from the disposal area.
- 5.4.6.7. Machine tamping, rolling, or hydraulic compaction of final cover shall not be permitted; however, hand tamping may be allowed where necessary to stabilize the soil to prevent erosion or the intrusion of extraneous water.

- 5.4.6.8.** If dosing is used in conjunction with an absorption trench or seepage bed system, the dosing chamber shall be sized to account for the volume of the distribution system and the dosing frequency.
- 5.4.7. *Serial Distribution System.*** A serial distribution system may be used in all situations where a soil absorption system is permitted and shall be used where the ground slope exceeds 30 percent and does not allow for suitable installation of a single-level absorption field, unless a distribution box or dosing chamber is used. The horizontal distance from the side of the absorption system to the surface of the ground shall be adequate to prevent lateral flow and surfacing of effluent above ground. When a serial distribution system is used, the following design and construction procedures shall be followed:
- The bottom of each absorption field and its distribution line shall be level.
 - There shall be a minimum of 10 inches of soil cover over the gravel fill.
 - An absorption field shall parallel as closely as possible the ground surface contours to minimize variation in absorption field depth.
 - There shall be a minimum of 6 feet (horizontal measurement) of undisturbed earth between adjacent absorption field trenches and between the septic tank or other treatment unit and the nearest absorption field.
 - Adjacent absorption fields shall be connected with a relief line or a drop box arrangement such that each trench fills with effluent to the top of the gravel before flowing to succeeding trenches.
- 5.4.8. *Evapotranspiration Disposal of Effluent.*** An evapotranspiration system may be used exclusively or in combination with a soil absorption system.
- 5.4.8.1.** An evapotranspiration system shall be designed by a registered professional engineer who shall furnish design data for a complete review of the design.
- 5.4.8.2.** Data to be furnished shall include, but shall not be limited to, liner material and bedding, properties of the soil in the evapotranspiration bed, evaporation and moisture data, and provision for vegetation cover.
- 5.4.8.3.** When a high groundwater table, bedrock, fractured rock, or highly pervious material (percolation faster than 5 minutes per 1 inch) endanger the underground water, a durable and impermeable liner shall be installed to prevent the sewage effluent from entering the underlying formation or groundwater table.
- 5.4.8.4.** An evapotranspiration system shall be located in an area where there is exposure to sunshine.

- 5.4.8.5. The system bed shall be crowned and covered with a minimum of 4 inches of selected backfill material and with a vegetation cover.
- 5.4.8.6. The bed area shall be protected to prevent damage from vehicular or pedestrian travel. The ground surface shall be graded to deflect precipitation and other outside water away from the disposal area.
- 5.4.8.7. The following formula may be used as a guide for determining the area necessary for total evapotranspiration of septic tank effluent:

$$\text{Area (in square feet)} = \frac{\text{Design Flow (in gallons per day)} \times 586}{\text{Lake Evaporation Rate at the Site (in inches per year)}}$$

- 5.4.8.8. As an alternative, a system may be designed on the basis of a monthly water balance for the system. Such a design provides for total storage of average daily flows for all periods in which evapotranspiration is not shown to occur. The design shall also provide wicks (sand structures that penetrate through the rock media to the bottom of the bed) equal to 10 to 15 percent of the bed surface area. The wicks shall be uniformly spaced throughout the bed. Adequate surface area shall be provided to evaporate/transpire total annual average daily flows at a rate equivalent to local net lake evaporation over the remainder of the year. (If the system is designed as a percolation/evapotranspiration system, the storage and evapotranspiration capacities may be reduced by the volume of effluent percolating into the soil.)
- 5.4.8.9. Sand utilized in evapotranspiration or evapotranspiration/absorption beds for cover shall meet the gradation requirements provided in Figure 5070-5 and be approved by the Designer of Record:

Figure 5070-5: Gradation Requirements

Sieve Size	Percent Passing
4	100
40	50–55
200	<15

- 5.4.9. **Mound Systems.** A mound soil absorption system shall be designed by a registered professional engineer. The design shall be site specific and include specifications for fill material, base area size calculations, absorption area calculations, distribution networks, cap, topsoil, final grading, and other information pertinent to the construction of the system as may be requested by the health officer or his/her designated representative.

- 5.4.9.1. The distribution system shall be designed for uniform effluent application throughout the mound.
- 5.4.9.2. The effluent distribution system shall be graded to drain back to the dosing chamber or to be buried below the frost line.
- 5.4.9.3. The final slope of the mound backfill shall be no greater than 3 in 1 (3 feet horizontally in one 1 foot vertically).
- 5.4.9.4. The mound shall be planted with suitable vegetative cover.
- 5.4.10. **Gravelless Soil Absorption System.** All gravelless soil absorption systems shall be approved by the local department of health. Where permitted by the local board of health, these systems shall be limited to only those absorption area reductions given through the health department's certification. The absorption area of a chamber-type absorption system shall be equivalent to the footprint of the interior of the chamber (interior base area).
- 5.4.11. **Constructed Wetland Treatment.** Due to higher maintenance needs, constructed wetland treatment is not a preferred method. Use of this method of treatment must be approved by BIA. A constructed wetland treatment system shall be designed by a registered professional engineer. The design shall be site specific and include specifications for loading, capacity, liner material, filter media, density and species of plant material, effluent level, final discharge type, and other pertinent information as requested by the health officer or his/her designated representative. The design shall include estimates of effluent quality at the inlet and outlet. Sampling ports, or some other means of effluent sampling, are needed to demonstrate compliance with discharge guidelines.

5.5. Additional Design Criteria (Other Facilities)

- 5.5.1. **Graywater System.** A graywater system shall meet at least all minimum design and construction standards for a septic tank system based on the amount and character of wastes for the fixtures and the number of persons to be served.
- 5.5.2. Any graywater reuse should be appropriately signed and safety measures used to mitigate potential cross-connection.

5070-6. Wastewater Collection

- 6.1. Prior to acceptance of any sewer line, the contractor shall be required to clean all lines under hydrostatic pressure to remove any stoppage or dirt from the lines.
- 6.2. Plan-Profile Drawing Stipulations
 - 6.2.1. Existing waterlines and sanitary sewers and new waterlines should be shown from the point of connection. In addition, necessary valves, fire

hydrants, ground storage tanks, pump stations, etc., as well as all pipe sizes should be indicated.

- 6.2.2.** Alignment, depth, flow direction, and size of all sanitary sewer lines should be determined and plotted. Also indicate location, elevation, and depth of manholes, catch basins, and water valves (horizontal and vertical).
- 6.2.3.** The preferred location of sewer mains is parallel to roadway right-of-way or curb line 10 feet outside of pavement edges. Prior to locating sewer mains within the roadway, a benefit versus long-term maintenance cost analysis must be submitted to and approved by the BIA. See further discussion in Paragraph 6.2.4.
 - 6.2.3.1.** Elevations should be indicated to the nearest 0.01 foot.
 - 6.2.3.2.** No planting of trees or placement of structures shall be allowed within 10 feet of either side of the sanitary sewer main.
 - 6.2.3.3.** Provision for marking sanitary structures and special fittings must be made.
- 6.2.4.** If the BIA approves the location of sewer mains within the roadway, the sewer mains should be a minimum of 4 feet from the outside of the pipe to the lip of the curb in the middle of the roadway section. If possible, sewer pipes should be located on the centerline.
- 6.2.5.** The BIA will consider topography in relation to layout and long-term maintenance when sewer mains are connected to existing systems.
- 6.2.6.** Show the existing ground profile and the inverts of sewer lines between manholes. Horizontal angular deflections should not be less than 90 degrees. The horizontal scale on profiles should not exceed 1 inch equals 100 feet, and the vertical scale should not exceed 1 inch equals 10 feet. Drawings should show location, size, material, type of pipe, service lines, cleanouts, lift stations, outfall sewer line, and treatment facility.
- 6.2.7.** Service lines connect the building piping to sanitary collection mains. No design analysis of gravity building connections is required unless the sewage flow exceeds the capacity of a 6-inch pipe on a 0.6 percent slope.
- 6.2.8.** Sewer lines shall be buried at a minimum of 2 feet of cover not subjected to vehicle loads; if exposed to traffic, a minimum of 3 feet of cover shall be maintained.
- 6.2.9.** Lift stations and treatment systems should be detailed, including a schematic flow diagram, all system mechanical equipment and interconnecting piping (all dimensions to the nearest inch), and an electrical schematic showing wiring and associated electrical equipment.

6.3. Design Flow Calculations

- 6.3.1. Where more than one building is involved, use gravity sewers. No more than one building will be allowed on a service line.
- 6.3.2. Pipe sizing is determined by Manning's formula. For gravity flow computations, use $n = 0.014$ for 12-inch or smaller pipe, and $n = 0.013$ for pipe larger than 10 inches.
- 6.3.3. To minimize excavation, locations of sewer piping should be determined by the topography of the site.
- 6.3.4. Sewer pipes should be a minimum of 8 inches in diameter and designed to run not more than 80 percent full.
- 6.3.5. The slope should provide a velocity of at least 2.5 feet per second at full flow and 2.0 feet per second at the average flow rate.
- 6.3.6. Pipe materials should be chosen based on structural loads, soil conditions, and characteristics of transported wastes. Pipe, bonding agent, and fittings should all be compatible. Polyvinyl chloride (PVC) plastic pipe is typically the most desirable for sewer systems and is preferred by the BIA. PVC shall conform to ASTM D3034, SDR 35 or 26 as the standard construction material. Use ductile iron pipe (DIP) or PVC pressure-rated pipe for force mains and other specialized piping. All pipe should be installed according to the manufacturers' recommendations.
 - 6.3.6.1. PVC pipe should be placed in 20-foot lengths (plus or minus 1 inch) for all sizes.
 - 6.3.6.2. Perforated distribution pipe surrounded by rock within a soil absorption system should conform to ASTM D2729.
 - 6.3.6.3. Open-joint pipe, cast iron, and tile pipe will not be utilized in individual sewage disposal systems.
- 6.3.7. Gravity sewer mains conveying raw sewage should have a minimum diameter of 8 inches; building service connections should have a minimum diameter of 4 inches.
- 6.3.8. Sewer services shall be installed perpendicular, not parallel, to the right-of-way.
- 6.3.9. Minimum grades are shown in Figure 5070-6.

Figure 5070-6: Minimum Gravity Sewer Main Grades

Pipe Diameter	Minimum Grade
101 mm (4 in.)	1.0%
152 mm (6 in.)	0.6%
203 mm (8 in.)	0.45%
254 mm (10 in.)	0.28%
305 mm (12 in.)	0.22%

6.3.10. All sewer mains should be installed at a uniform slope and with a straight alignment between manholes, which are to be installed at the end of each line.

6.3.11. Manholes

6.3.11.1. Use eccentric cones with a minimum internal diameter of 48 inches. For frames and covers, minimum access diameter is 22 inches, and minimum weight is 350 pounds. Use of different manhole sizes and types shall be allowed only upon written approval from the BIA.

6.3.11.2. Use a drop structure if the drop of the mainline sewer through the manhole exceeds 12 inches in diameter or if the sewer enters a manhole 2.0 feet or more above the manhole invert.

6.3.11.3. Space manholes at no more than 400 feet apart.

6.3.11.4. Provide 0.2-foot fall from the flowline inlet to the flowline outlet within the manhole.

6.3.11.5. Manhole steps shall be noncorrosive, 12 inches in width, manufactured of either aluminum or 0.5-inch steel rod encased with polypropylene. Steps shall be staggered 16 inches on center, withstand vertical loads of 400 pounds, and have a pull-out resistance of 1,000 pounds.

6.3.12. Service connections should use a wye branch to connect building services to the main sewer lines.

6.3.13. Cleanouts should be installed in the building service sewer every 100 feet, and at other appropriate locations.

6.4. Sewage Lift Stations and Force Mains

6.4.1. If gravity sewers cannot be provided, sewage pumps shall be installed in a sewage lift station constructed on the lowest terrain in the vicinity. The required pumping capacity, wastewater characteristics, lift station/force main hydraulic profile, pump and equipment characteristics, and design preferences should be submitted to the BIA prior to lift station design.

6.4.2. Lift stations may be pre-manufactured if approved by the BIA prior to design. Otherwise, lift stations will require a pump house design meeting architectural requirements acceptable to the BIA.

6.4.3. *Design Criteria*

- 6.4.3.1.** Either the wet well/dry well type or submersible lift stations are acceptable. Wet well/dry well may be either above ground or below ground. However, above-ground systems are preferred.
- 6.4.3.2.** Design to allow removal of pumps and motors without entry into the wet well.
- 6.4.3.3.** Components should be easily maintained, sampled, drained, pumped, inspected, and cleaned.
- 6.4.3.4.** Use the following equation to calculate the volume (V) of the wet well between start and stop elevations:

$$V = \frac{T * Q}{4}$$

where: V = volume in gallons
 T = the minimum recommended cycle time (minutes) between pumping cycles
 Q = the maximum pumping capacity (gallons per minute) of one pump

- 6.4.3.5.** Specify a minimum of duplex pumping units (equipped for automatic alteration). Use a design cycle time of 10 minutes (6 starts per hour per pump).
- 6.4.3.6.** Design a drawdown distance between start and stop points of between 12 inches and 39 inches.
- 6.4.3.7.** Shutoff and ball check valves should be provided on the discharge line of each pump, both located outside the wet well in an appropriately sized vault with adequate access. The check valves shall be suitable to handle raw sewage and are to be placed between the pump and shutoff valve.
- 6.4.3.8.** Ventilate all lift stations and equip them with audible and visual alarms that activate in the event of power failures, pump failures, unauthorized entry, and the use of the lag pump when the lead pump is running.
- 6.4.3.9.** Backup power is required for all sanitary lift stations. With a backup power supply, provide a minimum of 30 minutes of additional storage. Noise abatement is required to maintain decibel levels at existing background levels unless otherwise allowed by the BIA. If

backup power is not required by the state or local jurisdiction and if the BIA grants a waiver of the backup power requirement, provide a minimum of two hours of additional storage or as required by the state health department.

- 6.4.3.10. The electrical control panel should be a 14-gauge minimum thickness prewired NEMA 4 weatherproof/dustproof steel enclosure with a swing dead front cover and lock hasp. For each pump, supply a circuit breaker, magnetic starter with a 3-leg overload protection for 3-phase operation, hand-off-auto (H-O-A) switches, running time meters measuring hours and tenths, a red “pump failure” lamp, a green “pump running” lamp, and elapsed time meters.
- 6.4.3.11. Design of all pumps and electrical equipment in wet wells is to comply with the National Electrical Code for Class I, Group D, Division 1 locations.

6.4.4. *Force Mains*

- 6.4.4.1. Force mains should be a minimum of 4 inches in diameter to mitigate plugging.
- 6.4.4.2. Use a velocity of 3.5 to 5.0 feet per second in designing the force main. Velocities outside this range are not allowed without approval and should never go below 2 feet per second.
- 6.4.4.3. Force mains should enter a gravity sewer manhole at a point no more than 2 feet above the flowline of the receiving manhole and shall have a baffle device.
- 6.4.4.4. Force mains shall be PVC pipe conforming to ASTM D2241, adequate for the pressure developed by the pump system.
- 6.4.4.5. Consideration should be given to the maximum time sewage will remain in the system and every effort made to avoid a septic condition.

6.4.5. *Lift Station Pumps*

- 6.4.5.1. End suction pumps: Verify positive suction and priming capability.
- 6.4.5.2. Submersible: These pumps should pass 2-inch solids, minimum.
- 6.4.5.3. Lift station pumps shall be sized to accommodate the minimum velocities in force main piping while minimizing horsepower, minimizing rpm, and providing the best efficiency possible. The motor shall be non-overloading.

THIS PAGE INTENTIONALLY LEFT BLANK

5080-1. General

- 1.1. This section includes general minimum requirements, criteria, and guidance for the planning and design of storm drainage for BIA school facilities. All planning and design must provide control of storm drainage to protect the health, safety, and welfare of the school and its occupants. Proper planning and design shall ensure that the school is sufficiently above floodplains, does not interfere with existing drainage patterns, and does not contribute to or cause downstream flooding conditions. Design of all new construction shall be in conformance with this guideline, except as noted in paragraph 1.3.
- 1.2. Additional design and submittal requirements may be required for projects with unusual or more demanding site conditions.
- 1.3. The Designer of Record of the storm drainage facilities should be an active registered professional engineer in the state of the proposed school project and should be knowledgeable in local and federal drainage practices. Due to the variety of design situations, these guidelines are adjustable under the correct circumstances. In the event these guidelines do not apply to particular site conditions, provide a written explanation to the BIA and an appropriate substitute design narrative and/or calculations.

5080-2. Drainage Report**2.1. Submittal Requirements**

- 2.1.1. A drainage report must be developed by the Designer of Record that includes a narrative and the calculations necessary for the proposed drainage system. At a minimum, two submittals will be required, a preliminary drainage report and a final drainage report. These drainage reports shall be submitted with accompanying drainage plan(s) (map). Drainage reports shall be prepared on 8½ -inch-by-11-inch paper and suitably bound. The drainage plan may be either folded and bound with the report or folded and placed in a pocket that has been bound within the report. Two copies of these documents shall be submitted for review and approval by the BIA.

2.2. Preliminary Report

- 2.2.1. Prior to the approval of preliminary site plans, a preliminary drainage report for the project must be submitted and approved. The preliminary drainage report shall include preliminary drawings of all proposed drainage facilities, applicable drainage studies and reports, design computations, and such information as may be required to ensure that storm water originating from both the proposed school and the lands lying upgradient from the school will be adequately drained and controlled. The purpose of the preliminary report is to identify and define drainage problems associated with the proposed development and to define conceptual solutions.

2.3. Final Report

- 2.3.1.** Prior to the final approval of the project construction plans, the Designer of Record shall, at their expense, prepare and submit for review and approval by the BIA a final drainage report, which shall include detailed construction drawings, plans, profiles, and specifications for the construction and installation of all drainage facilities necessary for the drainage and control of all storm water within the school property and the conveyance of such water to a safe discharge or outflow point. The purpose of the final report is to translate the preliminary plan from a conceptual plan to a constructible plan. Such plan shall conform to the approved preliminary plans and reports and include all updates and changes requested by the BIA. Prior to the construction of any on-site improvements, the Designer of Record must obtain all necessary local, state, tribal, and/or federal permits.
- 2.3.2.** The BIA will review and make any comments deemed necessary on the submitted drainage report and drainage plan and return those copies to the Designer of Record. When the drainage report is deemed acceptable by the BIA, two additional copies of the drainage report and drainage plan must be submitted for the BIA's record copy.

2.4. Report Narrative

- 2.4.1.** The drainage report should include a narrative followed by an appendix with relevant calculations necessary for the proposed drainage system. At a minimum, the narrative should:
- 2.4.1.1.** State the proposed land use.
 - 2.4.1.2.** Give the general location and a description of the site. At a minimum, the name of the state, county, reservation, and where possible, township, range, and section. Define the area (in acres) of the site, in particular the area that will be disturbed by construction. Describe the relative locations of all state highways and/or local streets that provide access to the site.
 - 2.4.1.3.** Show the above street and highway information on an 8½ -inch-by-11-inch vicinity map within the report's appendix. The scale of the vicinity map should be appropriate to show the location of the project within the reservation with roads/highways leading up to the reservation.
 - 2.4.1.4.** Describe existing drainage facilities and major streams or rivers in the project vicinity that may have impact on or be impacted by the school or its proposed drainage facilities. This information should also be shown on the vicinity map.
- 2.4.2.** Describe existing ground cover, vegetation, and soil types, along with estimated runoff coefficients and infiltration opportunities.

- 2.4.2.1.** Describe historic drainage patterns in the area of the proposed development.
- 2.4.2.2.** Describe all irrigation facilities, both proposed and existing, that are located in or that may be affected by the project.
- 2.4.2.3.** Include all hydrologic and hydraulic design computations necessary to substantiate adequate sizing of all proposed drainage facilities. Describe and reference drainage analysis methodologies used in the report, including but not limited to the following:
- Design rainfall event(s), including the source of rainfall data used. The 10-year storm (initial event) and 100-year storm (major event) should be analyzed.
 - The runoff calculation method used (the Rational Method is suggested below).
 - Retention or detention and the storage calculation method used.
 - The methodology for determining proposed release rates from retention and detention ponds; describe any storm water that cannot practicably be detained.
- 2.4.3.** Description of the proposed drainage design should address the following:
- Major basins, including the effects of off-site tributary watersheds.
 - The boundaries of all sub-basin drainage areas on-site.
 - All conveyance elements, pipes, gutters, swales, culverts, overland flow, etc. Include their corresponding calculations, such as hydraulic grade line showing losses from friction, transitions, bends, junctions, and other losses, in the appendix.
 - Storm water collection inlets and other necessary storm water appurtenances.
 - Detention or retention, including available freeboard and proposed release structures.
 - Other proposed drainage facility design issues not described above.
- 2.4.4.** Present floodplain information for major drainage channels near or in the vicinity of the proposed school, including:
- A FEMA Flood Insurance Rate Map (FIRM) in the appendix, if available.
 - A description of the site in relation to both the 500-year flood and 100-year flood. If a floodplain study has not been prepared for the channel, the designer should evaluate both the 100-year and 500-year floodplain elevations.

- Any other flooding issues not already discussed, such as (but not limited to) shallow flooding zones.

2.4.5. Conclusions: Describe in the conclusion section how the proposed drainage design complies with or varies from the storm drainage criteria found in this handbook.

2.5. Drainage Plan

2.5.1. The drainage plan is a map or set of maps that graphically depict all elements of the drainage system described in the drainage report narrative. All elements shown on the drainage plan should coordinate with that narrative. Specifically, the drainage plan should include, at a minimum, the following:

2.5.1.1. *Historic Drainage Plan.* This is a scaled 24-inch-by-36-inch map that shows the following:

- Major basins, sub-basins, and drainage patterns on-site before the implementation and construction of the proposed development and their relation to the buildings and appurtenances on-site.
- Pertinent off-site drainage basins and drainage patterns that are tributary to the site.
- Existing drainage facilities and structures, including irrigation ditches, roadside ditches, crosspans, drainageways, gutter flow directions, and culverts. All relevant information such as material, size, shape, slope, and elevations should be shown.

2.5.1.2. *Proposed Drainage Plan.* This is a scaled 24-inch-by-36-inch map that shows the following:

- Major basins, sub-basins, and drainage patterns on-site after the implementation and construction of the proposed development and their relation to the buildings and appurtenances to be developed.
- Existing and proposed contours, shown at 2-foot-maximum intervals. In areas of little relief, 1-foot contours should be shown, and the existing contours should extend a minimum of 100 feet beyond the project limits.
- Property lines and easements, with purposes noted.
- Streets, indicating right-of-way width, flowline width, curb type, sidewalk, and approximate slopes.
- Proposed drainage facilities and structures and existing drainage facilities and structures not to be demolished, including irrigation ditches, roadside ditches, crosspans,

drainageways, gutter flow directions, and culverts. Include all pertinent information, such as material, size, shape, slope, and elevations.

- Proposed streets, ditches, gutters, and their slopes and flow directions.
- Proposed storm sewers and open drainageways, including inlets, manholes, culverts, and other appurtenances, including riprap scour protection.
- The proposed outfall point for runoff from the developed area and facilities to convey flows to the final outfall point without damage to downstream properties.
- Routing and accumulated flows at various critical points for the initial and major storm runoff (typically 10- and 100-year storms).
- Volumes and release rates for detention storage facilities and design information on their outlet works.
- Location and elevation of floodplains affecting the property.
- Pertinent off-site drainage basins and drainage patterns that are tributary to the site, along with the routing of these flows through or around the development.
- A legend to define map symbols, line types, etc.

5080-3. Drainage System Inspection

3.1. A professional engineer of the Designer of Record shall inspect the constructed drainage system to confirm its conformance with the approved drainage plan design. The following elements should be verified:

- Proposed finished floor elevations
- Sizes, grades, locations, and elevations of drainage structures, channels, pipes, etc.
- Basin boundaries and high points with the design drawings
- Detention/retention pond volumes and outlet works
- Facilities appear to be constructed in a workmanlike manner and functional

5080-4. As-Built Plan

4.1. Deviations from the approved drainage plan shall be annotated on the as-built plan.

4.2. The engineer shall include the following statement on the as-built plan:

I hereby declare that: I have performed a field review of the constructed drainage facilities on this plan, the facilities substantially conform to the approved drainage plan, appear to have been constructed in a workmanlike manner, and appear to be adequate for the intended purpose.

Registered P.E. State of _____
No. _____

5080-5. Drainage System Design

5.1. The drainage system Designer of Record should adhere to the following general guidelines:

5.1.1. Off-site flows are storm water flows entering the project area and shall be quantified and included in the drainage system design.

5.1.2. Drainage reports for off-site developed areas affecting the property shall be reviewed and considered in the drainage system planning and design.

5.1.3. Off-site flows should be received and discharged at locations existing prior to construction and in the manner that existed prior to construction.

5.1.4. Irrigation ditches should be considered full and should not be used to intercept or convey storm drainage. Wherever possible, storm waters are to be diverted around or away from irrigation ditches.

5.1.5. *Floodplains*

- Floodplain limits shall be delineated by scaling distances from FEMA maps and by plotting the base flood elevation on existing topography.
- Areas projected for inundation by the 100-year flood shall remain free of all structures and shall be preserved in as natural a condition as possible.
- If the project alters or improves a major drainageway, the Designer of Record must revise the floodplain as part of the project.
- All plans, details, calculations, and other requirements must be reviewed by the BIA before the developer submits plans to FEMA.
- Proposals to channelize and encroach on major drainageways will be reviewed on a case-by-case basis.
- Where drainageways have been designed to remain in their natural state, encroachments or alterations will not be allowed.
- Setback requirements will be determined based on the potential erosion and stream bank failure hazards. A minimum setback of 15 feet for any structure is required, with greater setbacks required as conditions warrant.

5.2. Hydrologic Calculations. Calculations supporting the drainage system design should use the following methodology, where applicable. Alternative methodologies should be used by the Designer of Record where applicable and should be technically justified and fully documented within the appendix of the drainage report.

5.2.1. The Rational Method. Use this computation method, as shown below, to calculate peak flows at critical design points of the project drainage system. The Rational Method should be applicable for small basins of 130 acres or less. All drainage system components should be sized to convey peak minor storm flows computed using this method. The Soil Conservation Service (SCS) method should be used for basins of 130 acres or more. Consideration will be given to other methodologies on a case-by-case basis.

5.2.1.1. The time of concentration, t_c , consists of an initial or overland time (t_i) plus the time of travel (t_t). t_c represents the time necessary for the most remote raindrop in the basin to reach the design point. t_t consists of travel time in a storm sewer, paved gutter, roadside drainage ditch, drainage channel, swale, or other concentrated conveyance element.

$$t_c = t_i + t_t$$

The initial or overland flow time (t_i) is calculated using the following equation:

$$t_i = \frac{1.8 * (1.1 - C_5) * L^{1/2}}{S^{1/3}}$$

where: t_i = initial or overland time (minutes)
 C_5 = runoff coefficient for 5-year frequency storm
 S = average basin slope (percent)
 L = length of overland flow (feet, maximum)

5.2.1.2. When it is determined that overland flow is longer than 300 feet, the first 300 feet should use the equation above. Beyond this initial 300 feet, the flow should be analyzed using the travel time (t_t) methods described below.

The velocity of flow can be computed using the hydraulic properties of the ditch, channel, curb and gutter, or storm sewer. t_t can then be computed in the following formula:

$$t_t = \frac{L}{60 * v}$$

where: t_t = travel time (minutes)
 v = velocity of flow (feet per second)
 L = distance of flow in hydraulic structure (feet)

t_c shall be at least 5 minutes.

t_c shall be the minimum of the following:

$$t_c = \frac{L}{180} + 10$$

where: t_c = time of concentration (minutes)

L = length of flow to design point from the most remote point (feet)

or

$$t_c = t_i + t_t$$

- 5.2.1.3. Locally accepted runoff coefficients (Cs) should be used when available. If local runoff coefficients are not available, use the Cs shown in Figure 5080-1.

Figure 5080-1: Alternative Runoff Coefficients

Location	Runoff Coefficient (C)
Business:	
Downtown areas	0.70–0.95
Neighborhood areas	0.50–0.70
Residential:	
Single-family areas	0.30–0.50
Multi-units, detached	0.40–0.60
Multi-units, attached	0.60–0.75
Suburban	0.25–0.40
Apartment dwelling areas	0.50–0.70
Industrial:	
Light areas	0.50–0.80
Heavy areas	0.60–0.90
Parks, cemeteries	0.10–0.25
Playgrounds	0.20–0.40
Railroad yard areas	0.20–0.40
Unimproved areas	0.10–0.30
Lawns:	
Sandy soil, flat, 2%	0.05–0.10
Sandy soil, average 2–7%	0.10–0.15
Sandy soil, steep, 7%	0.15–0.20
Heavy soil, flat 2%	0.13–0.17
Heavy soil, average, 2–7%	0.18–0.22
Heavy soil, steep 7%	0.25–0.35
Streets:	
Asphaltic	0.70–0.95
Concrete	0.80–0.95
Brick	0.70–0.85
Drives and walks	0.75–0.85
Roofs	0.75–0.95

5.2.1.4. Local, state, or tribal regulatory agencies may have 1-hour intensity-duration-frequency (IDF) curves specific to the site, which should be used if available. If not, IDF curves may be extrapolated from the National Oceanic & Atmospheric Administration (NOAA) atlas using the processes described within the atlas.

5.2.1.5. The design runoff shall be calculated using the following equation:

$$Q = CIA$$

where: C = the runoff coefficient

I = rainfall intensity derived from IDF curve (inches per hour)

A = drainage area (acres)

Q = design runoff (cubic feet per second)

5.3. Site Grading. Site grading shall be performed according to Section 5030.

Grading shall protect the project from all forms of flooding and should promote capture of as much runoff as practicable in the detention facilities. Specifically, grading shall closely adhere to the following constraints:

5.3.1. If the project is within a floodplain, the lowest floor, including the basement, must be elevated a minimum of 2 feet above the 500-year floodplain elevation. Habitable buildings shall not be located within the 100-year or 500-year floodplain.

5.3.2. Storm water from the school and other associated facilities should flow to roadway ditches, swales, channels, or storm piping that conveys the flow to the detention facilities.

5.4. Hydraulic Calculations. Hydraulic calculations supporting the drainage system should be documented in the appendix of the drainage report and should address the following at minimum:

5.4.1. Streets should primarily be used for traffic. However, streets can be an integral part of the drainage system, provided:

- The initial storm does not produce runoff that will overtop the curb. Water may spread to the back of walks where mountable curb and attached walk are used. For mountable curb with detached walk, water may spread to the crown of the street, but no crown overtopping is allowed for the minor event.
- The maximum water depth at the crown of the road is not greater than 6 inches in a major event. Flows exceeding these criteria may warrant oversizing storm sewers or beginning an off-street open channel system.
- Parking lots, whether or not used as detention, have a maximum depth of 1 foot for a driving lane and 1 foot for a parking space.

5.4.2. Open Channels. Open channels should be designed to integrate recreation and aesthetic needs, protect wildlife, support plant populations, and allow for bicycle and pedestrian trails. Open channels shall be designed for the 100-year storm, and effects of the 10-year storm should also be analyzed. Grass-lined channels and swales are preferred and shall be used unless physical restraints make their use unfeasible.

- 5.4.2.1.** Channels should be designed to avoid supercritical flows and flows near critical depth. The Froude number shall be less than 0.8.
- 5.4.2.2.** Side slopes shall be as flat as practical. Side slopes of 4 in 1 or flatter shall be normally considered for all areas to be vegetated.
- 5.4.2.3.** Trees and shrubbery shall not be permitted to grow in swales or major channels.
- 5.4.2.4.** Whenever feasible, the design of wetland bottomed channels is encouraged to slow down runoff and allow time for settling and biological uptake.
- 5.4.2.5.** Grass-lined channels should normally have a minimum slope of 2 percent. Where the natural topography is steeper than desirable, drops may be needed.
- 5.4.2.6.** Avoid using concrete-lined channels.
- 5.4.2.7.** Riprap-lined channels are permitted only in areas where space constraints prohibit the use of grass-lined channels. Riprap-lined channels shall be designed to have a Froude number of less than 0.8.
- 5.4.2.8.** Except where localized overflow in certain areas is desirable for additional ponding benefits or other reasons, the minimum allowable freeboard shall be equal to the velocity head plus 0.5 feet.
- 5.4.2.9.** For trapezoidal channels, the bottom width should normally be at least twice the depth of flow.
- 5.4.2.10.** Trickle channels or underdrain pipes to carry low flows are suggested in grass-lined channels.
- 5.4.2.11.** On larger swales located on sandy soils, a low-flow channel may be appropriate.
- 5.4.2.12.** Trickle channels should be lined with riprap or other scour-resistant materials.
- 5.4.2.13.** The maximum storm water velocity for the grass-lined swales should not exceed 5.0 feet per second in sandy soils, and should not be more than 7.0 feet per second for erosion-resistant soils. More stringent criteria may apply where soil conditions warrant. Channels shall be designed with proper and adequate erosion control features. Outlets from storm sewers, culverts, and tributary channels shall have

adequate riprap, cutoff walls, or other features to protect the outlet and the receiving channel from scour.

5.4.2.14. Proof of compliance with all applicable regulations, including Section 404 permits, are considered to be part of the design.

5.4.3. Storm Sewers. Storm sewers should adhere to the following:

5.4.3.1. Storm sewers shall be normally designed to convey minor storm flows without surcharging the sewer.

5.4.3.2. To promote self-cleansing, the minimum flow velocity in storm sewers shall be 2 feet per second.

5.4.3.3. The maximum velocity allowed in storm sewers shall be 20.0 feet per second.

5.4.3.4. Final design of storm sewers includes calculating the hydraulic and energy grade lines.

5.4.3.5. The energy grade line of all storm flows through pipes must be below proposed grade and manhole covers.

5.4.3.6. Storm sewer pipe shall not be less than 15 inches in diameter. Smaller pipe will be reviewed on a case-by-case basis.

5.4.3.7. Reinforced concrete pipe (RCP) should be used for all storm sewer pipes 18 inches or more in diameter.

5.4.3.8. Storm sewer pipe shall withstand HS-20 design loading in accordance with American Association of State Highway and Transportation Officials (AASHTO) *Standard Specifications for Highway Bridges* and with the pipe manufacturer's recommendation when the pipe is under roads or parking areas.

5.4.3.9. RCP shall be Class III or greater in all streets and tracts, regardless of whether or not heavy loads are expected.

5.4.3.10. Watertight rubber gaskets are required for all pipe joints.

5.4.3.11. Precast manhole sizes are based on the largest pipe size into or out of the manhole, assuming only one pipe in and one pipe out of the manhole. Increase precast manhole diameter to the next available size for each additional pipe entering the manhole. Figure 5080-2 shows manhole spacing and size.

Figure 5080-2: Manhole Spacing and Size

Pipe Diameter or Vertical Rise	Manhole Size	Maximum Manhole Spacing
15"–18"	48"	400'
24"	60"	400'
36"	72"	400'
48"	84"	500'
60"	96"	500'
Larger pipes require special manhole design and will be reviewed on a case-by-case basis.		500'

- 5.4.3.12. Horizontal alignment of pipe between manholes shall be straight.
- 5.4.3.13. Manholes are required wherever there is a change in size, direction, elevation, grade, or at lateral storm sewer junctions. Manholes may be waived for a short lateral that has a diameter of less than half of the storm sewer trunkline.
- 5.4.3.14. The minimum vertical separation to a water or sanitary sewer line is 18 inches. Lesser clearance requires concrete encasement or approved support for the affected utility.
- 5.4.3.15. Approved erosion control shall be designed and installed at all storm sewer outlets.
- 5.4.4. *Culverts.* A culvert is considered to be any structure that connects two open channels at a road crossing and should adhere to the following:
 - 5.4.4.1. The culvert must convey 100-year flows.
 - 5.4.4.2. The culvert, including inlet and outlet structures, shall convey water, sediment, and debris at all stages of flow.
 - 5.4.4.3. The required headwater depth will be limited by upstream conditions, but should not exceed 1.5 times the culvert diameter or 1.5 times the culvert rise dimension for shapes other than round.
 - 5.4.4.4. Excessive ponding above culvert entrances will not be acceptable if damage appears likely to surrounding property or to the roadway.
 - 5.4.4.5. Culverts should be designed with an emergency overflow path above.
 - 5.4.4.6. Culvert capacity should be analyzed using Bureau of Public Roads Hydraulic Engineering Circular No. 5. Both inlet and outlet control conditions should be analyzed.

- 5.4.4.7. Flared end sections or headwalls with wing walls are required on all culverts. Inlets are to be designed to minimize head losses. Scour protection is to be provided at all culvert outlets.
- 5.4.4.8. Culvert slopes shall prevent silting, yet avoid excessive velocities. Generally, the minimum culvert slope is 0.5 percent. Minimum barrel velocity is 3 feet per second and maximum is 21 feet per second.
- 5.4.4.9. Outlet velocities of all culverts must be checked. When outlet velocity exceeds maximum permissible channel velocity, energy dissipaters shall be provided to minimize potential erosion at the outlet.
- 5.4.4.10. Culverts shall be concrete unless otherwise approved by the BIA.
- 5.4.4.11. Culverts shall be designed to withstand H-20 loading in accordance with AASHTO *Standard Specifications for Highway Bridges* and with the pipe manufacturer's recommendation.
- 5.4.5. **Inlets.** Inlet design should adhere to the following:
 - 5.4.5.1. All inlets shall be designed to accept the minor storm after compensating for the effects of debris plugging. Inlets should generally be designed for 60 percent efficiency.
 - 5.4.5.2. The size of outlet pipes from storm water inlets shall be based upon the design flow rate at the inlet, but shall not be less than 15 inches in diameter.
 - 5.4.5.3. An emergency overflow must be provided for all inlets in a sump condition. All emergency overflows shall be designed for a 100-year storm, assuming that storm sewer pipes are plugged.
 - 5.4.5.4. Inlets shall be normally located in a low point, or at a point on a continuous grade where the initial storm runoff exceeds the curb capacity of the street.
- 5.4.6. **Storm Water Quality Control.** Storm water quality control measures must be developed and implemented by the Designer of Record in conjunction with the overall drainage plan for the site. Water quality ponds reduce the amount of sediment released into downstream drainage channels.
 - 5.4.6.1. Infiltration-type structural best management practices (BMPs) shall be designed to capture and treat the first 1/2 inch of rainfall from the development. The following formula calculates water quality control volume:

$$WQCV = (A * I * \frac{1}{24})$$

where: A = developed watershed area (acres)
 I = percent impervious of the developed area (expressed as a decimal)
 $WQCV$ = water quality control volume (acre-feet)

- 5.4.6.2. Designers are required to add half of the minimum water quality control volume to the detention volume when detention and water quality ponds are combined. The full water quality control volume must be captured for water-quality-only ponds.
- 5.4.6.3. Improved water quality should be attained by allowing sediment to settle to the bottom of the water quality pond before storm water is released from the pond. It is recommended that this be done through an outlet structure inside the water quality pond. For outlet structure design considerations, see below.
- 5.4.6.4. Trickle channels should not be used for ponds whose sole purpose is to provide water quality.
- 5.4.7. **Detention/Retention.** On-site detention or retention is required for all school projects. In some cases, full retention of storm drainage may be necessary. Exemption from the detention requirement may be allowed by the BIA if storm runoff is discharged directly into a regional detention pond sized to accommodate developed flows from the project area.
 - 5.4.7.1. Detention should be provided by means of open-space or parking lot detention.
 - 5.4.7.2. Underground detention may be used as a last resort, when all other alternatives are exhausted.
 - 5.4.7.3. Rooftop detention is not allowed.
 - 5.4.7.4. Parking lot detention may be used provided the maximum water depth does not exceed 12 inches.
 - 5.4.7.5. Where possible, utilize multi-purpose sports fields or landscaped areas to supplement the volume of a detention pond, provided maximum standing water depths are limited to 12 inches, the sports field is graded to rapidly shed water as the detention pond recedes, and the lowest part of the pond is substantially separated from the field to minimize periods of standing water on the field.
 - 5.4.7.6. Open ponds should be planted with resilient native grasses that can sustain frequent soggy and dry periods.
 - 5.4.7.7. To minimize standing water, detention ponds should be able to completely drain within 40 hours.

- 5.4.7.8.** Detention pond storage shall be designed for both the 10-year and 100-year events. Required detention volumes may be determined using $V = KA$, where V equals the detention volume for the design storms in acre-feet and A is the tributary area in acres.

$$\text{For the 100-year storm } K_{100} = \frac{1.78I - 0.002I^2 - 3.56}{1000}$$

$$\text{For the 10-year storm } K_{10} = \frac{0.95I - 1.90}{1000}$$

where: I = tributary basin's composite imperviousness percent

- 5.4.7.9.** Alternate methods for computing detention volumes can be found in the Federal Highway Administration's Hydraulic Engineering Circular No. 22.
- 5.4.7.10.** Allowable release rates in cubic feet per second (cfs) from the ponds for the 10- and 100-year storms can be computed from the ratios shown in Figure 5080-3. The predominant National Resources Conservation Service (NRCS) or SCS soil group for the total basin area tributary to the detention pond shall be used for determining the allowable release rate.

Figure 5080-3: Allowable Release Rates (CFS/Acre)

Storm Frequency	SCS Hydrologic Soil Group		
	A	B	C and D
10-year	0.13	0.23	0.30
100-year	0.50	0.85	1.00

- 5.4.7.11.** The allowable release rates for all other methods shall be the historic undeveloped flow rates from the tributary basin area.
- 5.4.7.12.** Available pond volume shall be calculated using the following formula:

$$V = \sum \frac{(A1 + A2 + (A1 * A2)^{1/2}) * Depth}{3}$$

where: $A1$ = contour area at Elevation 1
 $A2$ = equals contour area at Elevation 2
 $Depth$ is equal to Elevation 2 – Elevation 1

- 5.4.7.13.** The pond bottom shall include a trickle channel having a capacity at least 3 percent of the inflow discharge. The longitudinal slope for trickle channels shall be at least 0.5 percent. The pond bottom

cross-slope shall be at least 2 percent.

- 5.4.7.14. Access ramps to the pond bottom shall be provided for maintenance.
 - 5.4.7.15. Access ramps must be at least 8 feet wide with a 10 percent or flatter longitudinal slope.
 - 5.4.7.16. The ramp need not be paved, but must be of all-weather construction and capable of sustaining loads caused by maintenance equipment.
 - 5.4.7.17. Retention pond volumes should be calculated based on methods from local jurisdictional criteria or from Hydraulic Engineering Circular No. 22.
 - 5.4.7.18. The minimum freeboard for open-space detention or retention facilities is 1 foot above the computed 100-year water surface elevation.
 - 5.4.7.19. Emergency overflow shall be explicitly addressed in the design, and the 100-year peak inflow shall be used as a minimum basis for designing pond emergency overflow structures.
 - 5.4.7.20. All drainageways outfalling into a detention/retention pond shall have adequate erosion protection and energy dissipation at the outlets.
 - 5.4.7.21. All pond slopes shall be 4 in 1 or flatter.
 - 5.4.7.22. Inflow facilities to wetland bottom ponds shall have their inverts at least 1 foot above the pond bottom to allow for deposition of sediment.
- 5.4.8. **Outlet/Release Structures.** Outlet/release structures shall be designed as simply as possible and shall require little attention for proper operation.
- 5.4.8.1. Typically, an orifice plate is installed on the outlet structure to regulate released flows from the detention and water quality pond. The water quality orifice(s) should be sized to allow the WQCV to drain over a 40-hour period.
 - 5.4.8.2. Outlet structures inside ponds used for both water quality and detention should be staged through the use of orifices or weirs so that the WQCV drains first, then the minor event, and finally the major event. The orifices and/or weirs should be sized to precisely regulate the release of minor and major storms.

5.4.8.3. A trash rack should be placed over each detention pond or water quality outlet structure and should be designed as follows:

- Trash racks must have a net opening area of at least four times the area of the outlet orifice, but in no event less than 3 square feet.
- Trash rack bar spacing shall not exceed 6 inches and shall be no larger than half the diameter of the smallest dimension of the outlet orifice.

5080-6. Drainage System Construction

- 6.1.** Contractors responsible for such construction or installation shall comply with the licensing and permitting requirements set forth by the BIA and all applicable federal, state, local, and/or tribal laws.
- 6.1.1.** The contractor cannot construct, install, place, or attempt to construct, install, or place any storm drainage system extension or related subsurface structure or facility without first having procured BIA approval.
- 6.1.2.** It shall be the responsibility of the Designer of Record to obtain any permits required for construction, placement, or installation of the proposed drainage facilities under Section 404 of the Clean Water Act. Refer to Section 5040 of this handbook for guidance on preparing a storm water management plan (SWMP).
- 6.1.3.** Unless otherwise agreed to by the BIA, it shall be the responsibility of the Designer of Record to obtain any floodplain map amendments or revisions required as the result of the project construction.

THIS PAGE INTENTIONALLY LEFT BLANK

5090-1. General

- 1.1. This section provides roadway layout guidelines for BIA school facility projects. Road systems should provide convenient, safe access for automobiles, school buses, emergency vehicles, service vehicles, waste collection vehicles, and large trucks delivering supplies to the school site.
- 1.2. Site disturbance should be held to a minimum beyond building perimeters, roadways, curbs, walkways, utility trenches, etc., as delineated by the U.S. Green Building Council’s LEED-NC rating system.

5090-2. Street Layout

- 2.1. Housing and institutional areas shall be separated, but serviced, from the main access road. Wherever possible, curvilinear and looped streets shall be used within the housing areas.
- 2.2. Streets should run parallel with the natural ground contours.
- 2.3. Street layout should eliminate potential traffic control problems and consider large trucks and/or school bus activity, emergency vehicles, and fire protection access.
- 2.4. At dead ends, provide turnaround circles at least 100 feet in diameter between curbs.

5090-3. Horizontal Alignment

- 3.1. Design speed shall be as shown in Figure 5090-1.

Figure 5090-1: Alignment Controls

	Design Speed (mph)	Maximum Grade (Percent)	K Factor		VCL Min. Length (Feet) Crest	VCL Min. Length (Feet) Sag	SSD (Feet)	Min. Radius (Feet)
			Crest	Sag				
Arterials	50	6	160	75	120	80	450	955
Low density/ rural	45	*6	120	65	90	70	375	745
Collector 4-lane	45	*5	120	65	90	70	375	745
Collector 2-lane	35	*5	50	50	50	50	250	425
Local	25	*5	20	30	50	50	150	150
Private drive	15	*5	20	30	50	50	100	100

* Eight percent may be allowed by the BIA where an alternate access route, at 6 percent or less, exists. In severe weather climates, flatter grades than those shown should be used.

3.2. Street Grades

- 3.2.1. Provide spot elevations to the nearest 0.01 foot at street intersections and at all grade breaks and alignment breaks, and at 50-foot intervals on the back of sidewalk, back of curb, flowline, and centerline to provide a full cross section.
- 3.2.2. Specific project requirements will define whether surfaced streets shall be constructed with or without curb and gutter. Street widths shall be measured from flowline of curb to flowline of curb. Where curb and gutter are not used, street widths shall be from inside of shoulder to inside of shoulder.

3.3. Horizontal Curves. The minimum centerline radius for horizontal curves shall be as shown in Figure 5090-1. Variances from these requirements for local streets only will be considered on a case-by-case basis, if justified in writing by the Designer of Record.

3.4. Intersections

- 3.4.1. *Turning Radius.* All roadways shall intersect at right angles. See Figure 5090-2 for curb return radius requirements.

Figure 5090-2: Curb Return Flowline Radius at Intersections

	Local	Collector	Arterial
Driveway 21 or more spaces	35	35	35
Local or private street	35	35	35
Collector	--	35	35
Low-density rural	35	35	35
Arterials	--	--	35

- 3.5. **Superelevation.** Superelevation may be required for arterial roadways and selected collector roadways. Horizontal curve radius and superelevation shall be in accordance with the recommendations of AASHTO.
- 3.6. **Barricades.** Whenever roadways terminate due to project phasing, subdivision boundaries, etc., barricades are required. A note shall be placed on the plans directing the contractor to construct permanent Type III barricades (as specified in MUTCD) across the roadway terminus.

5090-4. Vertical Alignment

- 4.1. Design controls for vertical alignment are shown in Figure 5090-1.
 - 4.1.1. *Permissible Roadway Grades.* Designers are encouraged to avoid grades that are less than 0.75 percent to prevent maintenance and icing problems. The minimum allowable grade for any roadway is 0.5 percent. The maximum allowable grade for any roadway is shown in Figure 5090-1.

4.1.2. Permissible Grades Approaching Intersections

- 4.1.2.1. The maximum grade at intersections shall be 3 percent for the distances shown in Figure 5090-3.
- 4.1.2.2. At intersecting arterials, the maximum permissible grade shall be 2 percent for 200 feet on either side of the flowline of the intersecting street.
- 4.1.2.3. Private driveway, parking lot drive, and fire lane grades may be 4 percent maximum when sloping toward the public street and up to 6 percent maximum when sloping away.
- 4.1.2.4. The maximum slope for single-family driveways is 12 percent. In all cases where driveways are steeper than 10 percent, there shall be an accompanying pedestrian walk to the main entry with steps as needed to allow a maximum slope of 10 percent on the walk, in areas not requiring ADAABAAG access.
- 4.1.2.5. To accommodate ADAABAAG access, the maximum cross-slope of a crosswalk shall be 2.0 percent.

Figure 5090-3: Permissible Intersection Grade

	Local (Feet)	Collector (Feet)	Arterial (Feet)
Private driveways and streets	65	65	75
Local	95	100	125
Collector	--	120	200
Low-density rural	--	120	200
Arterial	--	--	200 (2.0 percent)

4.1.3. Grades Changes

- 4.1.3.1. Continuous grade changes, or “roller-coastering,” shall not be permitted. The use of grade breaks, in lieu of vertical curves, is not encouraged.
- 4.1.3.2. If a grade break is necessary and the algebraic difference in grade does not exceed 0.50 percent every 25 feet, the grade break will be permitted, except at intersections where an algebraic difference in grade of 0.80 percent will be permitted to facilitate the warping of the side street to meet the through street.

4.1.4. Cross-Slopes

- 4.1.4.1. Except at intersections or where superelevation is required, new roadways shall be level from top of curb to top of curb with a 2 percent crown as measured from centerline to lip of curb, or lip of

median curb to lip of outside curve on roadways with raised center islands.

- 4.1.4.2. Parabolic or curve crowns are not allowed.
- 4.1.4.3. The cross-slope of a street intersecting a street of higher classification shall be warped to match the grade on the higher-classification street.
- 4.1.4.4. Maximum pavement cross-slope is 4 percent at intersections, as measured above. The rate of change in pavement cross-slope to match the through street shall not exceed 1 percent every 25 feet horizontally on a local roadway, 1 percent every 40 feet horizontally on a collector roadway, or 1 percent every 50 feet horizontally on an arterial roadway.
- 4.1.4.5. Separate flowlines shall be shown until a standard cross section is obtained.

4.1.5. *Vertical Curves*

- 4.1.5.1. All vertical curves shall be symmetrical and shall meet the design criteria in Figure 5090-1. The minimum grade within a sag (sump) vertical curve is 0.50 percent.
- 4.1.5.2. All vertical curves shall be labeled, in the profile, with length of curve (L) and K ($K = L/A$, where K = the horizontal distance needed to produce a 1 percent change in gradient, and A = the algebraic difference between the two tangent grades, as a percent), high/low points, point of intersection (PI), point of curve (PC), point of tangency (PT), and stations and elevations.
- 4.1.5.3. Refer to AASHTO's *A Policy on Geometric Design of Highways and Streets*.

4.1.6. *Intersections*

- 4.1.6.1. In addition to the other requirements set forth herein, the following criteria shall apply at intersections: The grade of the "through" street shall take precedence at intersections. At intersections of roadways with the same classification, the more important roadway, as determined by the BIA, shall have this precedence.
- 4.1.6.2. The elevation at the point of curb return (PCR) on the through street is set by the grade of the through street in conjunction with pavement cross-slope. In retrofit situations, pavement cross-slopes between 1 percent and 4 percent may be approved.
- 4.1.6.3. Carrying the crown of the side street into the through street is not permitted.
- 4.1.6.4. At an arterial-arterial intersection, a more detailed drawing of the entire intersection's drivability shall be provided.

4.1.6.5. Separate flowline profiles and pavement cross-slopes in the plan view shall be shown until a normal cross section is obtained on each side of the intersection, in addition to standard requirements of a roadway plan.

4.1.6.6. Show spot elevations in the intersection, on the plan view, on an approximate 15-foot grid. Show this information on separate plan and profile sheets at minimum scales of 1 inch equals 20 feet horizontally, and 1 inch equals 2 feet vertically.

4.1.7. Curb Returns

4.1.7.1. Minimum grade around curb returns, when turning water, shall be 1.27 percent. Label high-point elevation and distance from PCR. Label the station and elevation of the upstream flowline intersection when a crossspan is required.

4.1.7.2. Maximum fall around a curb return equals the steepest grade (greater than or equal to 2 percent) coming into or out of a return multiplied by the length of the return, plus 0.2 feet.

4.1.8. Connection with Existing Roadways. Connections with existing roadways shall be smooth transitions. If the algebraic difference in grade (A) exceeds 0.50 percent, a vertical curve shall be used to transition the grade following criteria herein.

5090-5. Specification for Fire Lanes, Private Streets or Drives, and Parking Lots

5.1. General. This section provides design requirements in addition to those listed elsewhere in this chapter that specifically address private streets, driveways, parking lots, and fire lanes. For more information, refer to Section 5030.

5.2. Curbs. Vertical or combination curbs shall border all private streets, unless their omission is approved by the BIA.

5.3. Parking Area and Parking Lots. Island noses for landscaping, utility access, or pedestrian access may be located within areas of perpendicular parking stalls, but no island may project within 18 feet of the centerline of the street. Curb radii shall be a minimum of 3 feet except in locations allowing drive-through access.

5.4. Accessible Ramps. Wheelchair access shall be provided along designated pedestrian paths from each area of parking to adjacent buildings and connecting sidewalks.

5.4.1. Ramps shall be a minimum of 4 feet wide with a maximum 1 in 12 slope, and a maximum 6-inch rise. Flared ramp sides shall not exceed 1 in 10. Landings with a minimum 3 feet length shall be provided at the tops of curb ramps.

5.5. Permissible Grades. The maximum permissible grade for fire lanes is 7 percent. The maximum permissible grade for single-family residential

driveways is 12 percent. Where grades are in excess of 10 percent, there shall be an accompanying pedestrian walk to the main entry with steps to keep the slope of the walk to a maximum of 10 percent.

5.6. Parking Spaces. Minimum parking space sizes are 9 feet in width by 18 feet in length. Provide handicapped-accessible parking in accordance with the ADAABAAG .

5.6.1. Use of recycled material to assist with LEED credit is an option for wheel stops.

5090-6. Roadway Specifications

6.1. Following in Figure 5090-4 is a summary of the minimum roadway requirements.

Figure 5090-4: Roadway Specifications

Roadway Type	Minimum Roadway Width, Flowline to Flowline (Feet)	Type of Sidewalk, Curb, and Gutter
Parking drive aisle	24 feet + curb (if applicable)	6-inch vertical curb and gutter (2 feet)
Private drive	26 feet	6-inch vertical curb and gutter (2 feet)
Local street	26 feet	6-inch vertical curb and gutter (2 feet)
Four-lane collector	52 feet	6-inch vertical curb and gutter (2 feet)
Two-lane collector	42 feet	6-inch vertical curb and gutter (2 feet)
Low-density rural	28 feet	4-foot gravel shoulder on each side
Six-lane arterial	76 feet (3-lane: 38-foot roadways; 12-foot min. raised median)	6-inch vertical curb and gutter (2 feet)
Four-lane arterial	64 feet (2-lane: 32-foot roadways; 14-foot min. center island)	6-inch vertical curb and gutter (2 feet)
Local commercial and industrial	24 feet	N/A
Fire lane	24 feet	N/A

5090-7. Traffic Control Devices

7.1. All devices such as traffic control, signage, and markings should be designed in accordance with MUTCD.

7.1.1. Signs should be explicit in function, providing regulations, warnings, and guidance information for road users, displaying both symbol and word messages.

7.2. Signs should be illuminated or reflective to convey the same information during the day and night, unless specifically stated otherwise.

7.2.1. Figure 5090-5 provides guidance in choosing sign coloring.

Figure 5090-5: General Sign Color Code Meaning

Color	Associated Meaning
Black	Regulation
Blue	Evacuation route
Brown	Recreational and cultural interest area guidance
Fluorescent pink	Incident management
Fluorescent yellow-green	Pedestrian, bicycle, playground, school bus, and school warning
Green	Indicated movements permitted, direction guidance
Orange	Temporary traffic control
Red	Stop or prohibition
White	Regulation
Yellow	Warning

7.2.2. Markings, including pavement, curb, object markers, delineators, colored pavements, barricades, channelizing devices, and islands are used to supplement other traffic control devices. Consider possible limits to visibility caused by weather and debris when establishing marking frequency.

7.2.3. Crossing control for gaps in traffic flow should be monitored to provide safe crossing for students.

7.3. Signage and Striping

7.3.1. In the overall street system layout and design, include traffic control and safety devices, signage and pavement marking, and striping to guide vehicular and pedestrian traffic.

7.3.1.1. Speed limit, fire lane, and caution signs should be posted consistently throughout the campus.

7.4. Bridges

7.4.1. For purposes of these criteria, a bridge is defined as a structure, including requisite supports, erected over a depression or an obstruction (water, highway, or railroad) and having a passageway for carrying traffic or other moving loads.

7.4.2. A bridge is further defined as having a minimum length of more than 20 feet between undercopings of abutments.

- 7.4.3.** Bridge roadway widths shall meet typical widths for standard roadway lane widths.
- 7.4.4.** Where feasible, a culvert or box(es) shall be used in lieu of a span bridge. Where a bridge is recommended by the Designer of Record, a registered professional engineer shall provide design documentation meeting road and bridge standards for the State Department of Transportation.

5100-1. General

1.1. This section provides paving design guidelines for road, street, and parking lot areas for BIA school facilities. Soil conditions should be examined by a geotechnical engineer for recommendations related to paving and subgrade preparation prior to the start of paving.

1.2. Applicable Publications

1.2.1. Road and paving materials and methods shall be in accordance with the State Department of Transportation construction and materials specifications.

1.2.2. Pavement markings within public rights-of-way shall be in accordance with the *Manual on Uniform Traffic Control Devices (MUTCD)*.

5100-2. Soil Compaction

2.1. Based on the documented soil type over which the pavement will lie, minimum compaction requirements should be met. Refer to geotechnical recommendations.

2.2. **Subgrade Conditions.** All soil groups, excluding A-1 through A-4, shall be tested to determine swell or settlement potential as part of the geotechnical evaluation. The swell tests shall be plotted and the percent swell/settlement and swell pressure shall be determined and reported. Test results that are suspected of being too high or too low for the soil type shall not be considered in the design of the pavement, but shall be reported. Any deletion of data shall be justified in the report. The swell/settlement potential for a given soil shall be the calculated average of each of the classification groups.

2.2.1. As a minimum, the report shall specify the required depth of moisture treatment of the subgrade. That depth shall be determined by the highest average percentage of swell, recorded as a whole number as indicated in Figure 5100-1.

Figure 5100-1: Moisture Treatment Requirements*

Swell Potential	Depth of Moisture Treatment	Depth of Chemical Stabilization Treatment
< 3 percent swell	1 foot	----
>3 percent < 5 percent swell	3 feet or	----
	1.5 feet	1 foot
> 5 percent swell	1.5 feet	1 foot

* Indicated average percentage of swell as recorded to the nearest whole number. Moisture treatment shall achieve a moisture content and compaction as specified by the geotechnical engineer.

2.2.2. Soils with a greater than 5 percent swell shall also require swell mitigation in addition to moisture treatment.

2.2.2.1. Stabilizing agents: The preapproved stabilizing agents are listed in Figure 5100-2. Various combinations of these materials may also be used, subject to a suitable mix design by the geotechnical engineer. In the event that stabilized subgrade is used for the purpose of swell mitigation, either lime or a combination of lime and fly ash should be used as a stabilizing agent.

Figure 5100-2: Preapproved Stabilizing Agents

Agents	Must Conform to the Requirements of:	
Lime	ASTM	C977, C110
Fly ash (C and F)	ASTM	C618
Cement kiln dust	ASTM	D5050
Portland cement	ASTM	C114

2.2.2.2. High-calcium quicklime shall conform to the requirements of ASTM C977. Fly ash may consist of Class C or Class F; Class F fly ash shall be allowed only in conjunction with lime or other stabilizing agents.

2.2.2.3. All soil stabilizing methods and materials shall be defined by the geotechnical engineer.

5100-3. Materials

- 3.1. Base gravels, asphalt, and asphaltic concrete pavements for streets and parking lots should be consistent with State Department of Transportation standard specifications for the state in which the project is located.
- 3.2. Concrete paving is the preferred paving material. In selecting pavement material, the Designer of Record is to consider geotechnical recommendations, weather, and budget parameters.

5100-4. Vehicular Considerations

- 4.1. In designing pavement thickness, consider the street or roadway category (arterial, collector, local) along with vehicle type and maximum weight, and traffic volume (number of trips).

5100-5. Pavement Systems

5.1. Flexible Pavements

- 5.1.1. Compacted aggregate base shall consist of stone, gravel, or slags with appropriate composition and gradation in accordance with the geotechnical report and the State Department of Transportation.

- 5.1.2. Use locally available materials and gradations that exhibit a satisfactory record of previous installations.

5.2. Rigid Pavements

- 5.2.1. Rigid cement concrete pavements above base course include conventional and modified pavements for walks, roads, parking lots, and service areas.

5.2.2. *Materials*

- 5.2.2.1. Concrete: ASTM C150, Type II; Portland cement; ASTM C33, normal-weight aggregates; potable water unless the geotechnical engineer designates otherwise.

5.2.2.2. Design mix:

- ASTM C94, 4,000 psi, 28-day minimum compressive strength.
- The water/cement ratio should be 0.45.
- Slump limit at point of placement: 3 inches. Slump limit for concrete containing high-range water reducing admixture (superplasticizer): not more than 8 inches after adding admixture to site-verified 2- to 3-inch slump concrete.
- Air content: 5 to 8 percent; broom finish.

- 5.3. Reinforcing. Reinforcing shall be provided in areas of heavy loading, such as trash pads, bus pads, service drives, fire truck access road areas, etc. Acceptable reinforcing includes the following for concrete paving in areas with standard loading:

- Wire mesh: Welded plain steel wire fabric, ASTM A185.
- Reinforcing bars: Deformed steel bars, ASTM A615, Grade 60.
- Fabricated bar mats: Steel bar or rod mats, ASTM A184, using ASTM A615, Grade 60 steel bars.
- Joint dowel bars: Plain steel bars, ASTM A615, Grade 60. Epoxy coated joint dowel bars, ASTM A775 with ASTM A615, Grade 60 plain steel bars.
- Liquid membrane forming and sealing curing compound: ASTM C309, Type I, Class A.
- Epoxy adhesive: ASTM C881.

- 5.3.1. Acceptable shrinkage control shall be provided, such as fiber mesh or welded wire fabric; proper chairing must be required for welded wire fabric.

5.3.2. The required thickness of nonreinforced concrete pavement is 6 inches, minimum, based on a 28-day flexural strength concrete of 650 psi and the established modules of subgrade reaction.

5.4. **Minimum Pavement Sections.** If the geotechnical engineer’s calculated pavement sections indicate thinner sections than the minimum pavement sections listed in Figure 5100-3, the minimums shown in Figure 5100-3 shall govern. The BIA may increase the minimum pavement section at any location if, in their opinion, conditions warrant. If the geotechnical engineer recommends thicker sections, then those recommendations are to be followed. All asphalt roadways will be paved with a minimum of two lifts, regardless of minimal thickness.

Figure 5100-3: Minimum Pavement Sections*

Section Usage Type	Full Depth Asphalt	Portland Cement Concrete (PCC)	Asphaltic Concrete (AC) and Aggregate Base
Arterials/4-lane collector	7”	7”	5” AC + 9” aggregate base
2-lane collector	6.5”	6”	4” AC + 8” aggregate base
Low-density rural/ local street/private drive	6”	6”	3” AC + 9” aggregate base
Parking, all other	6”	6”	3” AC + 9” aggregate base
Parking areas, cars only	5”	6”	3” AC + 8” aggregate base
Bus/service drives/ fire lanes	7”	7”	4” AC + 9” aggregate base

* For pavement section thicknesses that the geotechnical engineer certifies as being acceptable for the on-site soil characteristics, the BIA, at their discretion, may allow variance to the identified minimum sections.

5.5. **Gravel/Base Course/Local Acceptable Surface Material.** For areas of vehicular travel limited to service vehicles remote from the immediate vicinity of the school and areas used for overflow parking, a readily available gravel/base course or acceptable local material may be used. Adequate structural integrity for potential vehicle and fire truck loading must be provided. Additionally, adequate width and spacing from other structures such as fencing must be provided. A minimum of 5 feet separation is suggested.

5.6. **Pavement Labeling**

5.6.1. **Striping Paint.** Specify white, yellow, and blue fast-drying chlorinated rubber-alkyd type traffic lane marking paint, factory mixed, quick drying and nonbleeding AASHTO M248 (FS TT-P-115), Type III.

5.6.1.1. Thermoplastic resins for pavement markings may be an option if specified by the Designer of Record, but they are not needed for

school parking lots. Public roads can use this type of marking, as specified by the local Department of Transportation.

- 5.6.1.2.** All pedestrian crosswalks, parking spaces, and no-parking zones should be striped according to specifications. Striping should be 4 inches wide and white, except handicapped-accessible spaces, which will be blue.
- 5.6.2. *Wheel Stops.*** Used in areas where curb and gutter is not used and vehicles may track on landscape or natural turf areas, wheel stops shall be reinforced precast 3,500 psi air-entrained concrete, approximately 6 inches high, 9 inches wide, and 7 feet long, with chamfered corners and drainage slots on the underside.
- 5.6.3.** Provide two 3/8-inch diameter, 2-foot-long steel rods for anchoring each block to the pavement.

THIS PAGE INTENTIONALLY LEFT BLANK

6000-1. Introduction

- 1.1. This chapter shall be used as a guideline for landscape architects and landscape designers, as well as other disciplines, in the development and design of the landscape for new BIA school facilities. This shall encompass all outdoor areas associated with landscape, as well as technical aspects of irrigation, soil considerations, mulch treatment, and weed and pest management. The design shall be in conformance with these guidelines unless exceptions to them are granted by the BIA.
- 1.2. Refer to Chapter 1, “General Information,” and Chapter 2, “Presentation of Data,” for required documents, drawing and specifications formats, and other design and submittal requirements not discussed in this chapter.
- 1.3. Additional design and submittal requirements may apply for projects with unusual or highly technical criteria.
- 1.4. As applicable, the Designer of Record shall incorporate the sustainability strategies identified in Chapter 3, “LEED Goals and Guidelines.”
- 1.5. This guidelines in this chapter should be used in conjunction with those in the other chapters in this handbook, particularly Chapter 4, “Site Design.” The Designer of Record should also coordinate with other project consultants to be sure all site features are effective and compatible. Coordination with the architect and the civil engineer are required.
- 1.6. All landscape features must be weighed carefully for their initial cost, long-term maintenance cost and needs, durability, and their impact on the environment.

THIS PAGE INTENTIONALLY LEFT BLANK

6010-1. General

- 1.1. The site and landscape should be designed for consistency with the overall project scope and functional requirements as defined by the BIA. Use landscape materials to blend architectural elements with the site and surrounding area and to assist in achieving Leadership in Energy and Environmental Design (LEED) certification goals.

6010-2. Efficiency/Economy

- 2.1. Select and design materials, systems, and components appropriate to the project requirements.
- 2.2. Recognize and respect the existing site features and preserve and/or enhance them to the greatest extent possible.
- 2.3. Design systems and plantings so as to minimize short- and long-term maintenance.
- 2.4. Select environmentally sensible products and practices.

6010-3. Accessibility

- 3.1. Design the landscape areas to meet all applicable requirements under the Americans with Disabilities Act and Architectural Barriers Act Accessibility Guidelines (ADAABAAG).

6010-4. Safety

- 4.1. All products specified for the site should be considered for their safety in relation to the activities of children.
 - 4.1.1. Children may chew or eat anything. When choosing any plant species, consider carefully its toxicity to humans. Do not choose highly toxic plants (including but not limited to rosary pea, monkshood, daphne, English ivy, foxglove, lantana, castor bean, potato vine, belladonna, mescalbean, and oleander).
 - 4.1.2. Special care should be taken for the use and storage of cleaning or plant care chemicals.
- 4.2. See Section 6020 for all applicable codes, standards, and laws associated with safe materials for school sites.
- 4.3. Consider the use and location of plant material with respect to general safety and security, including such issues as open or restricted sight lines and limiting access to the site.

6010-5. Durability

- 5.1. All products and plant materials chosen for the site should be sufficiently resilient and durable to perform well in areas where children explore and play.
- 5.2. Choose products that will be durable in the site's climate.

- 5.3. When choosing a product, consider its ease of repair, restoration, or resistance to vandalism.
- 5.4. Plant material placement, as well as plant selection, is an important durability consideration and is discussed further in Section 6030.

6010-6. Existing Natural Systems

- 6.1. When choosing products and plant material, consider the product or plant's adaptability to the following (whether the material is native/local or imported):
 - 6.1.1. **Water and Drainage.** The water source and water availability are the most important components of landscape design. Landscape material, percentage of landscape to hardscape area, nonirrigated landscape, and other design solutions will be determined based on the availability of irrigation water for the site. Existing drainage patterns should also be considered when selecting plant material and landscape products. Along steeply sloped terrain use 6- to 12-inch rock that may be found locally for erosion control; do not plant larger caliber trees along steeply sloped areas.
 - 6.1.2. **Soil Conditions.** These may vary across the site. Existing conditions may require the addition of soil amendments or limit the plant material choices. Soils should be evaluated prior to plant selection for alkalinity, density, and water saturation and absorption properties. Soil tests such as these may be performed as part of the geotechnical testing; however, if any of the above-listed tests are not included in the geotechnical reports, they should be conducted separately.
 - 6.1.3. **Existing Vegetation.** High-quality specimens of existing vegetation should be considered for preservation whenever possible. Preservation reduces landscaping costs, provides mature landscape from the start of the project, and is an indication of existing site conditions. Existing plant material may include individual specimens or groups of trees, cacti, shrubs, forbs, vines, grasses, or perennials. Existing plant material that is considered invasive or a weed species by local or state jurisdictions should be removed using the most effective yet environmentally sensitive practices possible.
 - 6.1.4. **Climate Conditions.** Precipitation, wind, sun, and temperatures (as well as temperature fluctuations) should be considered when choosing plant material, paving materials, and site furniture. Exposure to particular climatic conditions may cause certain materials to deteriorate faster than others.

6020-1. General

- 1.1. For landscape design, follow all applicable current codes, standards, and laws. For a more general list of codes and standards that apply to BIA educational facilities, refer to Chapter 1, “General Information.” During design, report any required deviations from codes and standards to the Contracting Officer.
- 1.2. Where two codes, standards, or laws are applicable to the topic under review, use the more conservative or more stringent. Consult with the BIA Office of Facilities Management and Construction (OFMC) to resolve any questions or conflicts regarding application of codes and standards.

6020-2. Applicable Codes and Standards

- 2.1. The design criteria shall comply with the guidelines published by or contained in the following:
 - American Joint Committee on Horticultural Nomenclature *Standardized Plant Names*, Second Edition, 1942
 - American National Standards Institute (ANSI), specifically ANSI Z60.1 *American Standard for Nursery Stock*, developed by the American Nursery & Landscape Association (ANLA; formerly the American Association of Nurserymen)
 - American Society for Testing and Materials (ASTM)
 - Americans with Disabilities Act and Architectural Barriers Act Accessibility Guidelines (ADAABAAG)
 - ASTM F1292-99 Standard Specification for Impact Attenuation of Surface Systems Under and Around Playground Equipment
 - ASTM F1292-04 Standard Specification for Impact Attenuation of Surfacing Materials Within the Use Zone of Playground Equipment
 - ASTM F1487-01 Standard Consumer Safety Performance Specification for Playground Equipment for Public Use
 - ASTM F1951-99 Standard Specification for Determination of Accessibility of Surface Systems Under and Around Playground Equipment
 - Bureau of Indian Education *Educational Space Criteria Handbook*
 - Local and state building codes
 - National Electrical Code (NEC)
 - *National Best Practices Manual*
 - Occupational Safety & Health Administration (OSHA)
 - State, local, tribal, regulatory, health, and environmental agencies

- Underwriters Laboratories (UL)
- Uniform Plumbing Code (UPC)
- United States Department of Agriculture (USDA)
 - Rules and regulations under the Federal Seed Act
 - Hardiness zones per USDA publications
- U.S. Consumer Product Safety Commission (CPSC)
- Western Wood Products Association (WWPA)

6020-3. Personnel Qualifications

- 3.1. Persons qualified to provide landscape design services as described in this document must either:
 - 3.1.1. Hold a degree in landscape architecture or landscape design, or
 - 3.1.2. For each year short of graduation, have at least one year of experience under professional leadership and guidance to substitute satisfactorily for formal education.
- 3.2. The landscape Designer of Record must meet all requirements of registration and/or licensure in the state of the project.
- 3.3. The landscape contractor who will be installing the landscape must be appropriately registered as required by all state and local jurisdictions.
- 3.4. The irrigation designer and/or installer must be appropriately registered as required by all state and local jurisdictions. Work involving substantial plumbing for installation of copper piping, backflow prevention devices, and related work shall be executed by a plumber who is appropriately licensed by state and local jurisdictions.

6030-1. General

- 1.1. Landscape should be an integral part of the school site. Landscape materials will provide protection from sun and wind, provide a sensory experience, and improve the learning environment for students.
- 1.2. Vegetation will also define use areas and circulation routes, provide open-space buffers to adjacent land uses, supplement erosion control, and provide visual continuity between the buildings, the site, and the surrounding environment.

6030-2. Existing Vegetation

- 2.1. High-quality specimens of existing vegetation should be considered for preservation whenever possible. Preservation reduces landscaping costs, provides mature landscape from the start of the project, and is an indication of existing site conditions. It is the easiest and most cost-effective way to provide landscape on a site. Existing plant material may include individual specimens or groups of trees, cacti, shrubs, forbs, vines, grasses, or perennials.
- 2.2. Existing plant material that is considered invasive or a weed species by local or state jurisdictions should be removed using the most effective yet environmentally sensitive practices possible.
- 2.3. If existing landscape includes plants with thorns or spines, consider its proximity to activity areas and the hazards it may pose to children or other users of the site.
- 2.4. Existing vegetation that will remain should be protected during construction, using construction fencing and other means to clearly delineate areas of preservation.

6030-3. Plant Species Selection

- 3.1. Choose plants for their compatibility with and adaptability to the site's climate, soils, and use, and whenever possible, use vegetation that is drought tolerant and/or native to the school's climate.
- 3.2. Plants should be chosen for their durability and resilience. Schools provide a high-use, high-impact environment for plant material.
- 3.3. Group plant species with similar water requirements together.
- 3.4. No plants with spines or thorns should be placed in active-use areas. Use these plants only to screen or limit access to maintenance or service areas (detached from the school or dormitory buildings), or in an educational/teaching area.
- 3.5. Monocultures are not allowed. Plant variety promotes healthy plant communities and visual interest.
- 3.6. Conceptual plant locations, sizes, and types should be included as part of the preliminary landscape design.

- 3.7. A plant palette, including trees, shrubs, cacti, ornamental grasses, forbs, perennials, annuals, vines, and seed mixes should be nearly finalized at the final concept plan, but should be complete, and all plants labeled, for the final construction documents.

6030-4. Turf Areas

- 4.1. Consider the amount of anticipated foot traffic and water required when specifying turf areas.
- 4.2. When possible, use a turf blend with the lowest water requirements that will still achieve the desired affect.
- 4.3. On all sports field areas, specify a sports-turf blend compatible with the site's climate.
- 4.4. If an area is not located in a high-traffic area or intended to be used for frequent play, it is recommended that native or xeric seed mixes or gravel be used to reduce water use and the cost of installation and maintenance.

6030-5. Seeded Areas

- 5.1. Seeding is an excellent way to minimize cost and cover larger areas. Seeded areas will need to be monitored closely, specifically within the first year, for weeds.
- 5.2. Seeded areas can be irrigated or nonirrigated, but the seed type should be specified accordingly. All seed should meet United States Department of Agriculture rules and regulations under the Federal Seed Act.
- 5.3. The preferred method for seeding should be specified as drilling. If broadcast seeding is necessary, the chosen seed rate should be doubled, and if hydroseeding is necessary, the chosen seed rate should be multiplied by four. All seeded areas should be covered with a minimum of 1/4 inch of soil and rolled smooth.
- 5.4. Mowing is the best method to prevent the spread of weeds; areas should be mowed before weeds flower or go to seed and should be cut as high as possible while removing the seed or flower head. The frequency of mowing will be determined by whether the area is irrigated or nonirrigated and how rapidly weeds and the grasses are growing.

6030-6. Bed Areas

- 6.1. Schools provide a high-use, high-impact environment for plant material. Whenever possible, planting beds should be elevated or located around the edges and in corners of use areas. Do not create islands for bed areas unless they are elevated to a height that will not be walked over.
- 6.2. Carefully consider all plants' mature height and spread, and specify their placement appropriately.

- 6.3. Bed areas should not be tripping hazards; beds should be easily identifiable and delineated with edging. Edging can vary from rolled-edge metal to stone or masonry edging.
 - 6.3.1. Wood and plastic edging should not be used; they will require higher levels of maintenance and will weather and deteriorate more quickly than other materials.
 - 6.3.2. No metal edging without safe or rolled edges is allowed.
- 6.4. The edges of beds should be designed with smooth lines and not contain kinks or other shapes that are difficult to lay out in the field.
- 6.5. Weed fabric should be specified for all planting beds, except in areas of perennial or annual flowers. Fabric should be cut around plants, not tucked and folded.

6030-7. Foundation Plantings

- 7.1. Do not place shrubs, ornamental grasses, forbs, perennials, or annuals closer to a building than 5 feet from the center of the plant to the foundation of the building.
- 7.2. Vines that will be using the building or other vertical structure as a climbing surface should be placed approximately 1 foot from the structure.
 - 7.2.1. Consider the use of vines carefully. Maintenance, growth habit, and the structure's performance are some of the concerns involved in using and locating vines.
 - 7.2.2. Vines should be maintained to keep them from blocking windows, doors, signs, or light fixtures.
- 7.3. Do not place trees closer to a building than 15 feet from the center of the plant to the foundation of the building. Consider the mature spread of a tree, and place it appropriately. Do not place trees along steeply sloped terrain.
- 7.4. Minimize turf and seeded areas directly adjacent to building foundations. If these areas do contain turf or are seeded, provide a minimum 1-foot separation of concrete or rock mulch to allow for mowing and to prevent irrigation water from damaging the foundation and building walls.
- 7.5. Carefully consider the location of evergreen trees and shrubs, specifically in front of windows. Select species so that at maturity they will not be higher than the bottom of the window openings or wider than a wall face between windows.
- 7.6. Also carefully consider all plants' mature height and spread, and specify their placement appropriately.
- 7.7. If raised beds are included adjacent to the building, they should be designed with positive drainage away from the foundation, and waterproofing should be placed adjacent to the building. For these areas, coordinate with the architect and civil engineer.

- 7.8. Changes in the field may need to be coordinated with other Designers of Record to prevent conflicts between plant material and the building windows, utilities, and other design features.

6040-1. Water Conservation Concepts

- 1.1. Design landscapes that promote conservation and efficient use of water through plant selection and placement, irrigation product selection, and water management. All of these should be consistent with the specific site conditions. The use of native plant material is encouraged. Adapted plant material is also acceptable.
- 1.2. In areas where the annual natural average precipitation exceeds 30 inches a year, an automatic irrigation system is optional. However, a system for hand watering must be provided.
 - 1.2.1. For hand watering, specify hose spigots or quick-coupling valves. Place the spigots or quick-coupling valves at least 20 feet from building foundations.
- 1.3. In some regions, water conservation concepts may also be referred to as xeriscape (the term xeriscape is derived from the Greek word xeros, meaning dry, combined with landscaping; the term was coined by the Denver Water Department in 1981). The xeriscape concept provides seven principles for water conservation:
 - 1.3.1. **Planning and Design.** Site and landscape design should consider the future use of the space, existing sun and water availability, and other external influences such as views.
 - 1.3.2. **Soil Improvements.** The addition of soil amendments to improve the soil's water absorption properties is important for successful plant growth and efficient water use.
 - 1.3.3. **Efficient Irrigation.** Irrigation system methods that promote water conservation may include the appropriate use of the following water-efficient systems and components (also see "Irrigation System Design," below):
 - Drip irrigation systems
 - Pressure regulation systems
 - Low-head drainage controls
 - Reclaimed water systems
 - Rain override devices
 - 1.3.4. **Zoning of Plants.** Consider hydrozones as part of the landscape design. The hydrozone concept is to group species with similar light and water requirements together and within the same irrigation zones.
 - 1.3.5. **Mulches.** Mulching keeps plant roots cool and minimizes water evaporation. Mulches come in two types, organic (such as shredded cedar) and inorganic (such as rock or gravel). Organic mulches will need to be replaced over time, unless the plant material has covered the area and

replacement is not needed. Inorganic mulches should not be used on south or west sides adjacent to building walls, because these mulches tend to retain and radiate heat. However, they are an excellent choice for windy areas.

- 1.3.6. ***Turf Alternatives.*** Choosing a turf with low water needs may help reduce water consumption while still providing the appearance and benefit of conventional turf. However, turf chosen for play fields should be weighed first for its durability against the level of use, and for water use second.
- 1.3.7. ***Appropriate Maintenance.*** Regular maintenance, proper irrigation, and weed, pest, and disease management are all important components in a successful landscape.

6040-2. Water Source

- 2.1. The water source and water availability are the most important components of the landscape design. They will determine the amount of water available for all on-site design features.
 - 2.1.1. If using a limited water source, the quantity of irrigation water will be determined based on the remaining available water after the uses and needs of the buildings are finalized.
 - 2.1.2. Often the water for irrigation can be a different system from the one used for the buildings, and is not necessarily required to meet the highest standards of drinking water. This increases the options for irrigation water when potable water is limited.
- 2.2. If it is both cost effective and available, use reclaimed water for irrigation. Reclaimed water can be classified as nonpotable or graywater (conforming to applicable health codes).

6040-3. Irrigation System Design

- 3.1. For irrigation system design, consider soil types and infiltration rates. In order to avoid runoff, do not overspray onto nonirrigated or nonpermeable areas. Design for water application rates less than the infiltration rate of the soil.
- 3.2. The irrigation system design should consider site conditions, water pressure, potential fluctuations in pressure, water source, and other elements affecting the success of the system.
- 3.3. All irrigation equipment shall be institutional or commercial grade.
- 3.4. All products need to be compatible with other irrigation system components, and should function within the manufacturer's safe operating range.
- 3.5. The design of the irrigation system should include the use of drip irrigation for all trees and shrubs placed in nonturf areas.
- 3.6. Drip irrigation or misting spray heads (with adjustable heights) should be used in bed areas.

- 3.7. Spray irrigation should be used in turf areas.
- 3.8. Temporary irrigation methods can be considered for the establishment of native or other seed mixes. If permanent irrigation in seeded areas is desired, those areas can be irrigated using spray heads.
- 3.9. Conform to the requirements of the reference information listed below except where more stringent measures are required by local codes or specified in the contract documents:
 - American Society for Testing and Materials (ASTM) – Specifications and Test Methods
 - Underwriters Laboratories (UL) – UL Wires and Cables

3.10. Water Distribution Equipment

- 3.10.1. For efficiency and effectiveness, the design may incorporate spray, drip, or subsurface water distribution components.
- 3.10.2. Select sprinkler heads, drip irrigation, and subsurface equipment based on durability, ease of maintenance, and manufacturer's performance data, as well as on-site conditions.
- 3.10.3. Specify only sprinkler heads and drip irrigation equipment that has matched precipitation rates within each irrigation zone.
- 3.10.4. Design drip irrigation systems to meet the water requirements of plants from initial planting through maturity.
- 3.10.5. Where reclaimed water is used for irrigation, use the industry standard of equipment with purple markings or components—spray heads, valve boxes, and control valves (purple piping is not required)—to indicate that the water is nonpotable.

3.11. Control Systems/Control Valves

- 3.11.1. Include automatic electric control systems for efficient system operation on all irrigation systems.
- 3.11.2. Include automatic electric control valves to control flow to the various hydrozones.
- 3.11.3. Select the valves for reliable operation and to provide appropriate water quality.
- 3.11.4. Select pressure-regulating valves as needed.
- 3.11.5. Select isolation valves as appropriate to facilitate maintenance and repairs.
- 3.11.6. Use one valve box for each type of valve specified.
- 3.11.7. Use quick-coupling valves at the end of all main irrigation lines and elsewhere as needed to meet supplemental manual watering and maintenance requirements.

3.11.8. Specify air relief valves at the high points of all main lines as needed.

3.12. Filters

3.12.1. Incorporate filters that are recommended by the manufacturer of the primary irrigation system components.

3.12.2. Choose filters based on the characteristics of the water source.

3.12.3. Size filters based on system flow. Incorporate automatic purging of filters where warranted by water conditions.

3.13. Backflow Prevention Devices

3.13.1. Design systems to keep the pressure loss through the backflow prevention devices within the manufacturer's optimum operating specifications.

3.13.2. Install the devices according to local codes and Uniform Plumbing Code (UPC) guidelines.

3.14. Weather-Sensing Override Devices

3.14.1. To minimize automatic watering, specify rain-sensing override devices for all irrigation systems.

3.14.2. Optional weather-sensing devices include wind and/or freeze sensors. Freeze sensors may be beneficial in climates with common occurrences of early season freezing.

3.15. Piping

Figure 6040-1: Pipe Sizing

Pipe Classifications	Burying Depth
Main lines	18 inches minimum
Laterals	12 inches minimum
Drip tubing	4 inches minimum

3.15.1. Piping under paving should be designed and installed with a minimum cover of 18 inches between the top of the pipe and the bottom of the aggregate base under asphalt or concrete paving.

3.15.2. Careful consideration should be given to any irrigation piping that may need to be placed under existing pavement areas. The least intrusive and most efficient method shall be used. Any damage to existing pavement shall be repaired.

3.15.3. Coordinate pipe bury depths with frost line depth and local installation practices in cold weather climates to ensure proper installation.

3.16. Pressure and Velocity

- 3.16.1.** Size water meters to keep anticipated flows within the middle third of the operating range recommended by the system manufacturer so that pressure loss does not exceed 10 percent of the available static pressure.
- 3.16.2.** Do not allow the total system pressure loss to exceed the dynamic pressure minus the recommended operating pressure at the water distribution equipment.

3.17. Winterization

- 3.17.1.** Design irrigation system components for positive system drainage.
- 3.17.2.** The system shall be designed to be voided of water using compressed air or a similar method.

6040-4. As-Built Information

- 4.1.** In order to provide clear direction for maintenance personnel and the BIA, the following items should be provided at the time the irrigation system construction is completed.
- 4.2.** All as-built conditions should be documented, including:
- The installed configuration of connections to existing water lines
 - Sprinkler line routing
 - Sprinkler control valves
 - Quick-coupling valves
 - Manual drains and stop and waste valves
 - Drip-line blowout stubs
 - Control wire routing if not with the main line
 - Gate valves
 - Control wire and communication cable splices
 - Water meters
 - Flow sensors
 - Locations of all sleeving, including size, quantity, and depth
- 4.3.** Submit a set of three operating instructions, including winterization procedures and start-up procedures, with cut sheets of products and controller/watering operation instruction, to the owner's maintenance personnel.
- 4.4.** Provide one controller chart for each automatic controller installed. The chart may be a reproduction of a record drawing and, if scale permits, fit the controller door. The chart shall reflect the as-built conditions and show the area covered by that controller. All charts shall retain full legibility, even when reduced.

- 4.5. Provide the following items to use for maintenance at the time of construction completion:
- Two sets of special tools required for removing, disassembling, and adjusting each type of sprinkler head and valve installed on the project
 - Two 6-foot valve keys for operation of gate valves
 - Two keys for each automatic controller
 - Two quick-coupler keys and two matching hose swivels for each type of quick-coupling valve installed
 - Two aluminum drain valve keys of sufficient length for operation of drain valves

6050-1. Soil

- 1.1. As part of preliminary site analysis, soil testing should be initiated by the Designer of Record to determine the pH level, infiltration rate, salts, and the soil type. Preliminary testing is very beneficial, especially to determine any limitations that the soil type and pH may impose on plant species selections. Some of these tests may need to be repeated prior to installation to reassess disturbed areas. This will be in addition to any geotechnical or other soils testing.
- 1.2. Soils may vary in composition and saturation levels throughout the site; multiple areas should be checked, specifically areas with noticeably different elevations, microclimates, or vegetation.
- 1.3. Strip and save suitable existing soil for reuse in landscaped areas where possible.

6050-2. Soil Amendments

- 2.1. The addition of amendments to improve the soil's water absorption properties is important for successful plant growth and efficient water use.
- 2.2. Construction activity will disturb and/or compact soils; prior to landscape installation, an organic soil amendment should be added to disturbed and compacted soil areas.
- 2.3. The type and amount of soil amendment will be determined by soil testing as described above.
- 2.4. All soil amendments shall be evenly distributed and then appropriately tilled into the soil to provide an even mixture between existing soil and amendment material.

6050-3. Mulch

- 3.1. The use of mulches in planting beds and around newly planted trees will help keep plant roots cool and minimize water evaporation. Two types of mulch are acceptable, organic (such as shredded cedar) or inorganic (such as rock or gravel).
 - 3.1.1. Organic mulches will need to be replaced over time, unless the plant material has covered the area and replacement is not needed.
 - 3.1.2. The use of inorganic mulch should be minimized on south or west sides adjacent to building walls, because these mulches tend to retain and radiate heat. However, they are an excellent choice for windy areas.
- 3.2. Fine grade all planting beds to be mulched, allowing for a full depth of mulch.
- 3.3. Mulch in beds adjacent to walks and paved areas should not protrude above the paved surface.

THIS PAGE INTENTIONALLY LEFT BLANK

6060-1. General

- 1.1. Integrated pest management (IPM) is a practice that encourages the use of biological and cultural pest control and the minimized use of chemicals, herbicides, and pesticides to achieve acceptable pest levels with the smallest impact on human health, safety, and flora and fauna within the environment. IPM is the preferred method of weed, disease, and pest management for BIA school facility landscapes.

6060-2. Design Concepts

- 2.1. Select plant species for their adaptability to the site and the local climate.
- 2.2. Create and install an integrated and functional site design that minimizes the need for chemical applications.
- 2.3. Provide appropriate quantities of moisture through the correct design and installation of the irrigation system.
- 2.4. Use fencing and mesh during installation, as appropriate, to help control damage to young plants by deer, rodents, waterfowl, and other animals. As plants mature, these measures can be reevaluated on a case-by-case basis.

6060-3. Installation and Maintenance Considerations

- 3.1. Plants and seeded areas should be properly installed to minimize plant stress and help ensure that plant materials are successfully established.
- 3.2. Following through with good maintenance practices and appropriate fertilization applications will promote healthy plant material.
- 3.3. Not all weeds and pests will be eradicated using IPM, but reducing chemical applications will benefit the plants and humans on-site in the long run. Consequently, an acceptable level of pests and weeds on the site will need to be determined as part of reducing the need for chemicals. An integrated weed, disease, and pest management plan and maintenance plan should be developed between the BIA and on-site maintenance staff.
- 3.4. Weeding should be done frequently by hand or by mowing, so that weeds do not go to seed.
- 3.5. Mechanical and biological measures should be used first, with the careful addition of less-toxic sprays and a final consideration of the least-toxic chemicals.

THIS PAGE INTENTIONALLY LEFT BLANK

7000-1. Introduction

- 1.1. This chapter shall be used as a guideline in the design of all new BIA school facility buildings. The procedures and systems here will help the Designer of Record create attractive, durable, cost-effective buildings that will be economical to maintain and provide a healthy educational environment. Building design should be based upon recognized and sound commercial building practices. The design shall be in conformance with these guidelines unless exceptions to them are granted by the BIA.
- 1.2. Refer to Chapter 1, “General Information,” and Chapter 2, “Presentation of Data,” for required documents, drawing and specifications formats, and other design and submittal requirements not discussed in this chapter.
- 1.3. Additional design and submittal requirements may apply for projects with unusual or highly technical criteria.
- 1.4. As applicable, the Designer of Record shall incorporate the sustainability strategies identified in Chapter 3, “LEED Goals and Guidelines.”
- 1.5. The guidelines in this chapter should be used in conjunction with those in the other chapters in this handbook, and the Designer of Record should coordinate with the other project consultants to be sure all aspects of the school facility are effective and compatible.
- 1.6. All design features must be weighed carefully for their initial cost, long-term maintenance cost and needs, durability, and their impact on the environment.

7000-2. Content

- 2.1. To aid in the design process, a detailed collection of requirements and acceptable building systems has been compiled and is presented in the following sections. These standardized systems are not meant to unduly limit the design but rather to reduce costs and ensure a consistent level of quality for all BIA school facilities.

7000-3. Design Considerations

- 3.1. The Designer of Record shall ensure that building massing, forms, and layouts offer efficiency of initial and operating costs. Modular dimensions and standard sizes shall be used to the greatest extent possible.
- 3.2. Facility design shall consider building expansion. The Designer of Record shall coordinate the extent of this effort with the BIA.
- 3.3. Below-grade tunnels and crawl spaces are prohibited.
- 3.4. Combustible construction is prohibited without prior written approval of the BIA. All wood used, such as for blocking or substrates, shall be fire treated.
- 3.5. Where humidity levels remain at 60 percent or higher or walls are exposed to direct moisture for extended periods of time, the use of water resistant gypsum board is required. If such areas have limited air movement, gypsum board walls

shall be resistant to microbial growth.

- 3.6.** The Designer of Record shall develop the architectural design to minimize energy usage. Building systems and components must be coordinated from the project inception to produce an energy-efficient design. The envelope design must be incorporated into the energy model discussed in Chapter 10, "Mechanical."

7000-4. Compliance Requirements

- 4.1.** It is recognized that not all design professionals will agree with the choice of the systems shown in this chapter. However, the systems included have been identified through comprehensive performance evaluations and meet the goals of the BIA for their educational facilities. Consequently, the Designer of Record is required to use the specified building systems unless permission to do otherwise is stated in the following sections.

7010-1. Role of the Designer of Record in Systems Selection

- 1.1. While these guidelines present a selection of preapproved systems, it is ultimately the responsibility of the Designer of Record to determine which of the systems is most appropriate for any given project. The Designer of Record must analyze the various considerations included within the individual systems sections to make final recommendations to the BIA. It is not the role of the Designer of Record to analyze components outside of the preapproved systems unless specifically allowed elsewhere in this chapter to do so.
- 1.2. The Designer of Record is to make all efforts reasonable to avoid custom fabrications. Standard sizes and installation techniques are to be used whenever possible.

7010-2. Considerations

- 2.1. This chapter provides the Designer of Record with a menu of approved systems that meet the BIA performance standards. In most cases, the Designer of Record will have more than one option.
- 2.2. These guidelines recognize that many variables exist, depending on market conditions, regional considerations, and design concepts. Considerations for the designer to analyze include, but are not limited to:
 - First costs
 - Lifetime costs
 - Expected system life
 - Maintenance
 - Durability
 - Local availability
 - Local expertise
 - Local tribal customs and heritage
 - LEED compliance
 - Energy and resource conservation
 - Climate
 - Schedule
 - Acoustics
 - Aesthetics
 - Fire ratings

THIS PAGE INTENTIONALLY LEFT BLANK

7020-1. General

- 1.1. For architectural design, follow all applicable current codes, standards, and laws. For a more general list of codes and standards that apply to BIA educational facilities, refer to Chapter 1, “General Information.” During design, report any required deviations from codes and standards to the Contracting Officer.
- 1.2. Where two codes, standards, or laws are applicable to the topic under review, use the more conservative or more stringent. Consult with the BIA Office of Facilities Management and Construction (OFMC) to resolve any questions or conflicts regarding application of codes and standards.
- 1.3. NFPA 5000 Building Construction and Safety Code is the primary code to be followed.

7020-2. Applicable Codes and Standards

- 2.1. The design criteria shall also comply with the guidelines published by or contained in the following:
 - American National Standards Institute (ANSI) S12.60 Acoustical Performance Criteria, Design Requirements, and Guidelines for Schools
 - ANSI/American Society of Mechanical Engineers (ASME) A17.1 Safety Code for Elevators and Escalators
 - Americans with Disabilities Act and Architectural Barriers Act Accessibility Guidelines (ADAABAAG)
 - National Fire Protection Association (NFPA) 13 Standard for the Installation of Sprinkler Systems
 - Occupational Safety & Health Administration (OSHA)
 - U.S. Green Building Council’s Leadership in Energy and Environmental Design (LEED) program
 - U.S. Public Health Service (PHS) *Food Service Sanitation Manual*

7020-3. Miscellaneous Accessibility

- 3.1. The gripping surface of circular railing or pipe serving as handrails on accessible stairs or ramps shall be 2-inch outside diameter (O.D.) railing or an equivalent 1½-inch *nominal* inside diameter standard pipe (1.900 inch O.D.). The clearance between handrails and adjacent supporting structures shall be 2¼ inches, minimum.
- 3.2. In gymnasiums, sports stadiums, or equivalent facilities, spectators are expected to stand during events. When wheelchair spaces are located behind spectators at these facilities, they shall be sufficiently elevated to provide lines of sight, to the playing field, that traverse over or between the heads of the standing spectators.

THIS PAGE INTENTIONALLY LEFT BLANK

7030-1. General

1.1. Show all moveable and fixed furniture and equipment on equipment and furniture plans and in a schedule. Identify each piece by a number, size, and description, and indicate who is to furnish and install it. Where fixed or built-in seating, tables, or work surfaces are provided in accessible spaces, make at least one of the seating spaces, tables, or work surfaces (and not less than 5 percent of the total) handicapped compliant.

1.2. Accessibility

1.2.1. When children (ages 3–12) are primary users, dining surfaces and work surfaces as well as elements that must be reached and/or operated, for example shower controls, elevator controls, dispensers, coat hooks, marker boards, shall be provided in accordance with ADAABAAG guidelines for children's use. ADAABAAG adult anthropometrics apply to students older than 12 years.

1.2.1.1. All work surfaces for children ages 6–12, and included lavatories and sinks, shall have a frontal approach with a minimum 24-inch-high open knee space. Those primarily used by children 5 years old and younger, where a 30-inch-by-48-inch clear floor space is available, are permitted to utilize a parallel approach without a knee space. The top of children's work surfaces shall be 30 inches maximum above the finished floor.

1.2.1.2. Spaces involving use by children 12 years old and younger, and by adult staff (and/or students older than 12), shall have two sinks to meet both adult and child anthropometrics.

1.2.2. Within accessible spaces, i.e., classrooms, laboratories, home economics areas, nurses' offices, dormitory kitchenettes and living rooms, teachers' workrooms, media center circulation areas and media center storage/work rooms, and concession and concession storage areas, at least one of each type of fixed furnishing and element used by staff, for example, work surfaces, sinks, marker boards, demonstration units, fume hoods and ventilation hoods, both within student areas and in separate preparation rooms, shall be designed compliant to ADAABAAG adult technical specifications. In other than common use areas, work surface knee spaces may be arranged as "adaptable," capable of being readily altered to accommodate the needs of disabled persons. Adaptability may not be used in common use areas such as teacher's workrooms, dormitory kitchenettes and living rooms, media center circulation areas, media center storage/workrooms, concession areas, and concession storage rooms. The adaptability concept may not be used for student applications.

- 1.2.2.1. Knee space adaptability involves the capability of removing cabinetry without relocating sinks or work surface countertops, finished flooring extending under the cabinetry, and finished walls behind and surrounding the cabinetry.
 - 1.2.3. When one or more ovens are provided in an accessible space, at least one oven shall have an adjacent, fully accessible work surface with knee space.
 - 1.2.4. When fixed upper cabinets are provided, whether in classrooms or common use spaces such as teachers' workrooms, the lower shelf of at least one shall be positioned in accordance with ADAABAAG adult reach range criteria.
 - 1.2.5. When storage elements are provided at an accessible room or space, at least one of each type of element, for example closets, cabinets, shelves, clothes rods, hooks, and drawers, shall comply with ADAABAAG reach range, clear floor space, and accessible hardware requirements. When children are the primary users, ADAABAAG children's accessibility criteria shall be used.

7030-2. Furniture/Equipment Schedule

- 2.1. Use an appropriate format for the furniture and equipment schedule, and include all pertinent information. Although you are not restricted to it, Figure 7030-1 shows an example of an appropriate format.

Figure 7030-1: Sample Furniture/Equipment Schedule

Equip. No.	Quantity	Description	New (N) or Existing (E)	Size (w x l x h)	CFI ¹	GFI ²	GFCI ³
1	5	Work tables	N	915 mm (36 in.) x 1830 mm (72 in.) x 762 mm (30 in.)	X		
2	2	Dynamometer	E	915 mm (36 in.) x 1220 mm (48 in.)		X	
3	1	Paint spray booth	N	3 m (10 ft.) x 6 m (20 ft.) x 3 m (10 ft.)		X	

¹CFI Contractor furnished and installed

²GFI Government furnished and installed

³GFCI Government furnished and contractor installed (use this designation only when so directed by the Contracting Officer)

7030-3. Representation on Floor Plans

- 3.1.** For new construction provide a separate floor plan showing the location of all moveable and fixed equipment. Show graphically whether the equipment item is CFI, GFI, or GFCI. Show CFI equipment with solid lines, and GFI equipment with dashed lines. Provide and install all built-in utilities or services necessary for the proper use of contractor-furnished or government-furnished equipment.

THIS PAGE INTENTIONALLY LEFT BLANK

7040-1. General

- 1.1. In schools, proper room acoustics are essential to conducive learning environments for students and to a comfortable working environment for teachers and staff. In dormitories, proper acoustics contribute to a comfortable living environment. To ensure proper room acoustics, school and dormitory designs must meet the criteria outlined in this section.

7040-2. Acoustical Design Approach

- 2.1. Acoustical design for BIA school facilities should follow a structured approach at each stage of the planning and design process. The following is an outline of the process for acoustical design.

2.1.1. Conceptual/Schematic Design

- Selection of the site
- Noise survey to establish external noise levels if applicable
- Orientation of buildings in relation to noise sources
- Massing and form of the buildings
- Consideration of the need for external noise barriers, using buildings, fences and screens, and landscape features
- Preliminary calculation of sound insulation provided by the building envelope, including the effect of ventilation openings

2.1.2. Design Development/Construction Documents

- Determine appropriate noise levels and reverberation times for the various activities and room types.
- Consider the special educational needs of the students.
- Consider the design of music, vocational education, and other specialty spaces separately from that of normal classrooms, as the design criteria are very different.
- Architectural/acoustic zoning: Plan the disposition of “quiet” and “noisy” spaces, separating them wherever possible by distance, external areas, or neutral “buffer” spaces such as storerooms or corridors.
- Consider sound isolation separately from other aspects of room acoustics, using walls, floors, and partitions to provide adequate sound isolation.
- Consider the volume and shape of rooms and the acoustic properties of their surfaces when designing room acoustics.
- Specify the acoustic performance of doors, windows, and ventilation openings.
- Specify any sound reinforcement systems.

7040-3. Acoustical Certification

- 3.1. The Designer of Record shall submit a letter to the BIA certifying that the design meets the acoustical performance requirements outlined in this section.

7040-4. Room Acoustics Criteria

- 4.1. In Figure 7040-1, below, design goals for reverberation times (T_{60}) are provided for each space. To meet the criteria (and approach the goal), the Designer of Record shall select finish materials to provide the required space-averaged noise reduction coefficients (NRCs) shown in Figure 7040-1. The NRC values of some common construction materials are given in Figure 7040-2 and should be used for calculations unless another value can be supported by laboratory test data of the selected material. The NRC values for ceiling tile and other materials that are not listed should be acquired from the product manufacturer (and based on laboratory tests).

Figure 7040-1: Room Acoustics Criteria

Room Description	Minimum Space Averaged NRC	Design Goal T_{60} (seconds)
Classroom	0.23	0.5
Science classroom	0.20	0.6
Art classroom	0.20	0.8
Private office	0.16	0.5
Computer lab	0.20	0.6
Conference room	0.22	0.5
Teacher work area	0.18	0.5
Media center	0.23	1.0
Dining room	0.18	1.4
Gymnasium	0.21	2.0
Music practice room	0.25	0.3
Fitness room	0.18	0.8
Locker room	0.18	0.8
Vo-tech classroom	0.18	0.8
Instrumental music room	(see note)	
Vocal music room	(see note)	
Multi-purpose music room	(see note)	
Dorm sleeping room	0.18	0.5
Dorm study room	0.16	0.5
Dorm activity room	0.23	0.5
Dorm living room	0.18	1.4

Note: To provide proper acoustical characteristics for this room, the acoustical design goals should be established on a case-by-case basis by qualified personnel or acoustical consultants. The room features, including its shape, volume, and diffusive and absorptive treatments, should be selected to achieve the established design goals.

Figure 7040-2: NRC Values of Some Common Materials

Material	NRC
Brick, unglazed and unpainted	.05
Brick, unglazed, painted	.00
Carpet, 1/4-inch pile height	.25
Carpet, 1/8-inch pile height	.15
Carpet, 3/16-inch combined pile and foam	.25
Classroom marker or chalk board, wall mounted	.05
CMU, coarse, unpainted and unsealed	.35
CMU, painted or sealed	.05
Concrete, sealed or painted	.00
Door	.05
Floor, vinyl composite tile	.05
Floor, wood	.10
Gypsum board, painted	.05
Metal roof deck, acoustical deck (perforated with insulation fill)	.35
Metal roof deck, exposed	.05
Window	.10

7040-5. Sound Isolation Criteria

- 5.1.** Most rooms in a school or dormitory can be grouped into the following categories:

Type A: Classrooms; art classrooms; media center; principal's office; counselor's office; health office; science classrooms; dormitory study, activity, and living rooms

Type B: Assistant principal's office; teacher work rooms; conference rooms; computer lab; dormitory sleeping rooms

Type C: Stairways; locker rooms; staff restrooms; fitness room

Type D: Instrumental, vocal, and multi-purpose music rooms; music practice rooms; student restrooms

Type E: Corridors

Type F: Mechanical and electrical rooms

The airborne sound insulation requirements between each type of space are given in the matrix shown in Figure 7040-3 (with the exceptions shown in the numbered notes). The requirements are listed as sound transmission class (STC) values. The selected walls or floor-ceiling assemblies should meet these requirements, based on their laboratory STC ratings or ratings estimated by qualified professionals.

To ensure compliance, the partitions may be field tested per ASTM E336 Standard Test Method for Measurement of Airborne Sound Insulation in Buildings. Sound insulation test results will be reported as a field sound transmission class (FSTC) value in accordance with ASTM E413 Classification for Rating Sound Insulation. The measured FSTC should be no more than five points below the required STC rating (according to Figure 7040-3). For example, a wall separating two classrooms should have a laboratory STC rating of 40, or a minimum FSTC of 35.

Figure 7040-3: Sound Transmission Class (STC) Ratings Between Spaces

	Type A	Type B	Type C	Type D	Type E	Type F
Type A	40	45	45	55	40	Note 4
Type B		40	45	55	40	Note 4
Type C			40	55	30	Note 4
Type D				60 Notes 1, 2	45 Note 3	Note 4
Type E						Note 4
Type F						Note 4

Notes: Wherever practical, the following guidelines should be followed:

1. Instrumental, vocal, and multi-purpose music rooms should not be located directly adjacent to one another.
2. Sound isolation between restrooms should be STC-40 or greater.
3. Sound isolation between a restroom and a corridor should be STC-40 or greater.
4. Separation of Type F rooms from other occupied spaces should be analyzed on a case-by-case basis. Where practical, Type F rooms should be separated from occupied space with a buffer space (i.e., storage rooms or other unoccupied space). In any case, the partition(s) separating the Type F room from the occupied room should be designed to reduce the intrusive noise into the occupied room to 5 decibels below the required mechanical noise criterion (NC) level at each octave-band frequency.

5.2. General Sound-Isolation Requirements

- 5.2.1. Sound-isolating gypsum board partitions should be installed and sealed per ASTM E497 Standard Practice for Installing Sound-Isolating Lightweight Partitions, and ASTM C919 Standard Practice for Use of Sealants in Acoustical Applications.
- 5.2.2. Doors in sound-isolating walls shall be solid-core wood or insulated metal doors. Where the wall must be rated for STC-40, the doors should be equipped with a perimeter smoke seal. Where the wall is rated for STC-45, the doors should be equipped with a perimeter smoke seal, an automatic door bottom, and threshold (if the floor is carpeted). For walls rated STC-55 or higher, the doors shall be an acoustically rated door assembly having an STC rating no less than five points below the wall rating.

5.2.3. Floor-ceiling assemblies over classrooms, conference rooms, offices, music rooms, dormitory sleeping rooms, and dormitory study rooms should provide impact noise isolation equal to or greater than an impact insulation class (IIC) of 50.

7040-6. Mechanical System Noise Criteria

6.1. The mechanical system design shall include means and methods to reduce the mechanical noise levels in occupied spaces to the levels shown in Figure 7040-4. The criteria are given as noise criterion (NC) ratings. These ratings must be maintained at any location within the room that may be occupied by a person as part of the normal use of the room.

Figure 7040-4: Mechanical Noise Criteria

Room Description	Maximum NC Rating
Classroom	35 ¹
Science classroom	35 ²
Art classroom	35
Private office	35
Computer lab	35
Conference room	35
Teacher work area	35
Media center	40
Dining room	30
Gymnasium	40
Music practice room	30
Fitness room	40
Locker room	40
Vo-tech classroom	40 ²
Instrumental music room	30
Vocal music room	30
Multi-purpose music room	30
Dormitory sleeping room	35
Dormitory study room	35
Dormitory activity room	35
Dormitory living room	35

Notes:

1. NC-35 is the maximum allowable noise level. A noise level of NC-30 is preferred.
2. This noise level may be exceeded when a dedicated exhaust fan is on.

THIS PAGE INTENTIONALLY LEFT BLANK

7050-1. General

- 1.1. The exterior wall systems in this section have been analyzed with a combination of specific evaluation criteria and identified as building systems that will meet the minimum performance criteria for BIA educational facilities. These approved wall systems from which the Designer of Record may choose vary according to different building types—maintenance facilities, schools, gymnasiums, and dormitories.

7050-2. Exterior Wall Selection Criteria

- 2.1. When making selections for exterior wall systems, the Designer of Record must consider the criteria discussed in Section 7010.

7050-3. Finishes

- 3.1. Finishes for exterior wall surfaces must be selected to minimize routine maintenance. Cementitious materials such as concrete, stucco, and concrete masonry units (CMUs) are to be integrally colored. Manufactured products such as metal panel shall be factory finished.

7050-4. Sectional Diagrams

- 4.1. The cross-sectional diagrams presented in this section are included as diagrammatic images only. Proper placement of vapor and air/moisture retarders, thicknesses of insulation, and sizes of masonry units and metal framing must be determined by the Designer of Record based on project-specific requirements.

7050-5. Design Flexibility

- 5.1. While a limited number of exterior wall systems that meet minimum performance requirements have been preselected by the BIA, it is intended that there be sufficient variation between those systems to allow for some design freedom and flexibility. Design concepts as well as local and cultural considerations will greatly affect the systems selection process.

7050-6. School Structures

- 6.1. School structures include classroom, study, administrative, cafeteria, and media center spaces. The approved systems listed below provide a thorough representation of durable, low-maintenance, high-performance exterior walls for schools. Following this list are descriptions and cross sections of each of the approved exterior wall systems for school structures.

6.2. Approved Exterior Wall Systems for School Structures

- CMU wall with masonry veneer
- Metal stud wall with masonry veneer
- Insulated concrete panels
- Metal stud wall with metal panel system
- CMU wall with stucco finish system
- Metal stud wall with stucco finish system

**Figure 7050-6(1):
CMU Wall with Masonry Veneer**

This wall system is a cavity wall system consisting of a CMU wall and brick masonry veneer. The insulation in this system is placed within the cavity, allowing the inner CMU mass to aid in regulating changes in temperature. An air/moisture retarder (location of air/moisture retarder to be determined by local climatic conditions) is provided to prevent moisture and air migration. The interior face of the CMU shall be furred to a depth sufficient to conceal electrical and IT equipment. With prior approval of the BIA, the interior furring may be eliminated in part or in all locations.

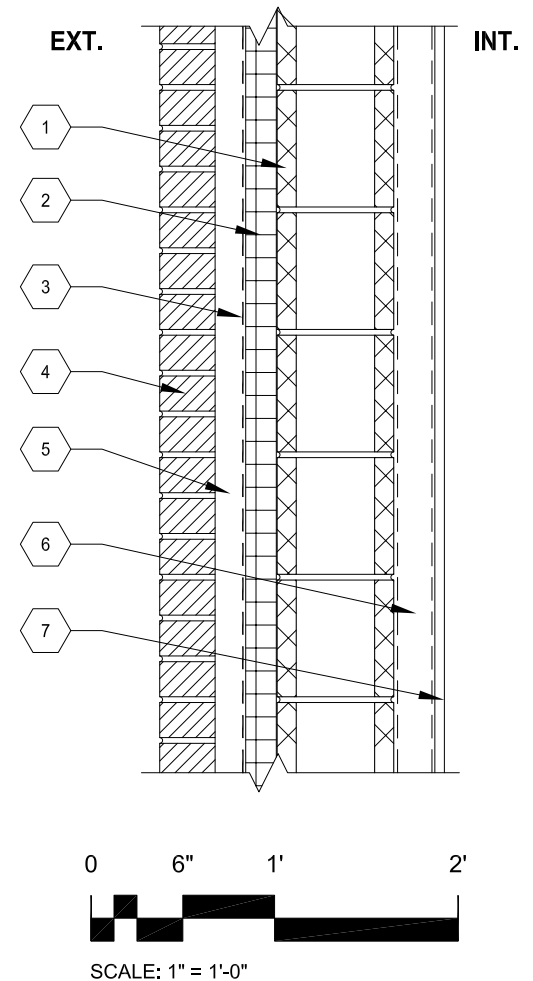

KEYNOTES:

1. CMU wall
2. Rigid insulation
3. Air/moisture retarder
4. Masonry veneer
5. Air space
6. Metal stud furring
7. Gypsum board

**Figure 7050-6(2):
Metal Stud Wall with Masonry
Veneer**

This wall system is a cavity wall system consisting of masonry veneer over stud infill or structural metal studs. The stud wall is provided with exterior wall sheathing in the cavity. An air/moisture retarder (location of air/moisture retarder to be determined by local climatic conditions) is provided to prevent moisture and air migration. A layer of rigid insulation is placed within the wall cavity to minimize thermal breaks at the studs. Additional batt insulation, if needed, is placed within the stud cavities.

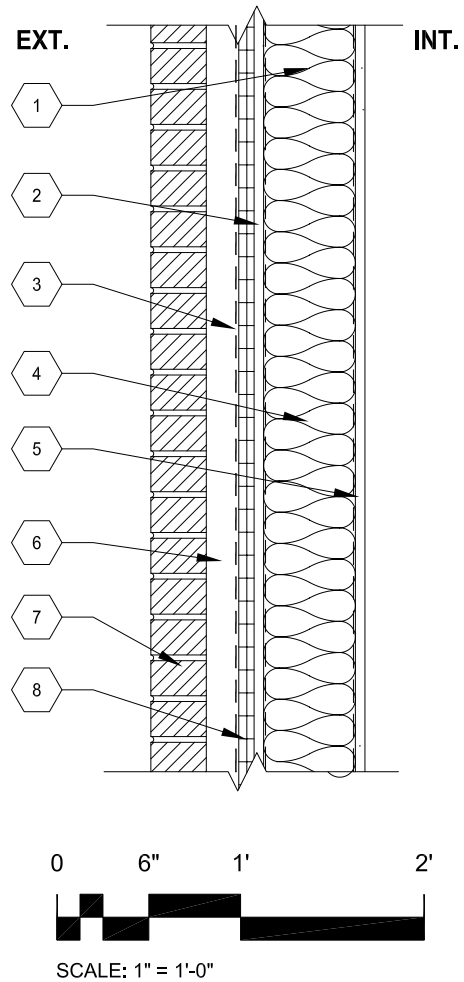

KEYNOTES:

1. Metal stud wall
2. Exterior sheathing
3. Air/moisture retarder
4. Batt insulation
5. Gypsum board
6. Air space
7. Masonry veneer
8. Rigid insulation

**Figure 7050-6(3):
Insulated Concrete Panels**

This wall system is a tilt-up or precast concrete insulated panel. A layer of rigid insulation and ties is sandwiched between a structural concrete panel and a veneer face panel. The interior face of the panel shall be furred to a depth sufficient to conceal electrical and IT equipment. With prior approval of the BIA, the interior furring may be eliminated in part or in all locations. Panel sizes and thicknesses will vary depending on structural loading and workable size.

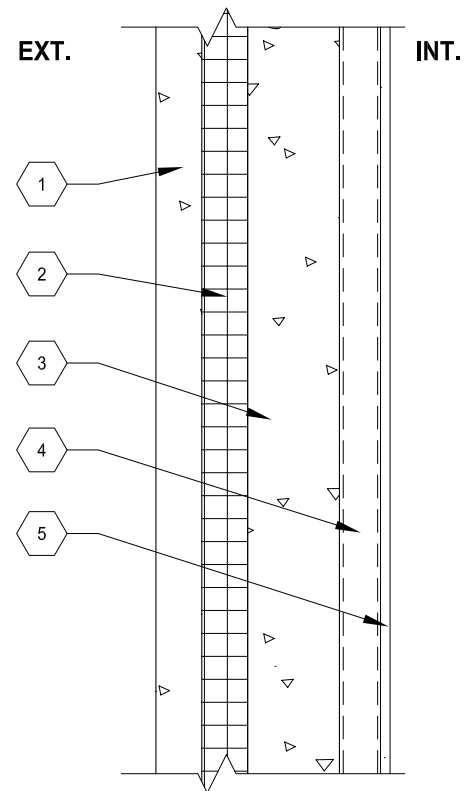

SCALE: 1" = 1'-0"

KEYNOTES:

1. Concrete face panel
2. Rigid insulation and tie system
3. Structural concrete panel
4. Metal stud furring
5. Gypsum board

**Figure 7050-6(4):
Metal Stud Wall with Metal Panel
System**

This system is a metal panel system applied over metal stud infill or structural studs. Exterior sheathing is applied to the outside face of the studs along with an air/moisture retarder (location of air/moisture retarder to be determined by local climatic conditions) is installed to minimize moisture and air migration. Thermal insulation is in the form of batt insulation placed within the stud wall. The metal panel system used may vary depending upon budget, aesthetic concerns, and constructability. The type of metal panels shall be determined by the Designer of Record. Metal panel systems must be installed a minimum of 10 feet above adjacent grades. All metal panel systems must be factory finished.

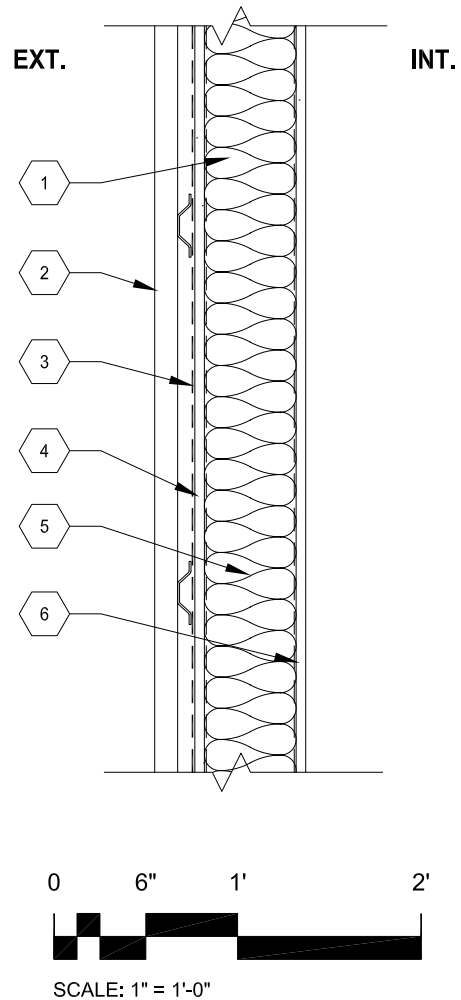

KEYNOTES:

1. Metal stud wall
2. Metal panel system
3. Air/moisture retarder
4. Exterior sheathing
5. Batt insulation
6. Gypsum board

**Figure 7050-6(5):
CMU Wall with Stucco Finish System**

This system consists of a 3-coat stucco system applied to a single-wythe CMU wall. The insulation in this system is rigid insulation applied to the exterior of the CMU wall and behind the stucco finish. This allows the mass of the CMU to aid in regulating temperature changes. An air/moisture retarder (location of air/moisture retarder to be determined by local climatic conditions) is installed to minimize moisture and air migration.. The stucco should be integrally colored or cement coated; the use of acrylic finishes on the stucco is not allowed. The interior face of the CMU shall be furred to a depth sufficient to conceal electrical and IT equipment. With prior approval of the BIA, the interior furring may be eliminated in part or in all locations.

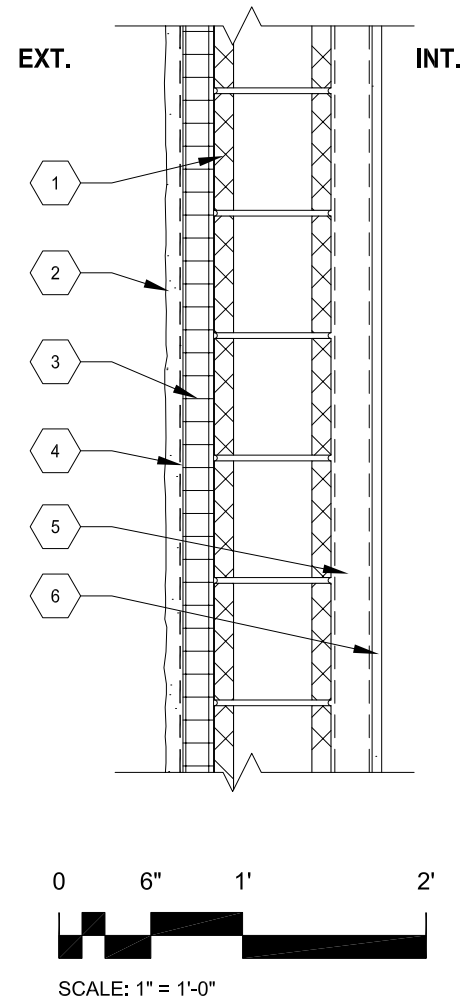

KEYNOTES:

1. CMU wall
2. 3-coat stucco system
3. Rigid insulation
4. Air/moisture retarder
5. Metal stud furring
6. Gypsum board

**Figure 7050-6(6):
Metal Stud Wall with Stucco Finish
System**

This wall system consists of a 3-coat stucco system applied to either a stud infill wall or a structural stud wall. Exterior sheathing is applied to the outside face of the studs along with an air/moisture retarder (location of air/moisture retarder to be determined by local climatic conditions) to minimize air and moisture migration. Batt insulation is placed within the stud wall and can be adjusted to meet regional requirements. The stucco system shall incorporate stucco lath over the air/moisture retarder. The stucco should be integrally colored or cement coated; the use of acrylic finishes on the stucco is not allowed.

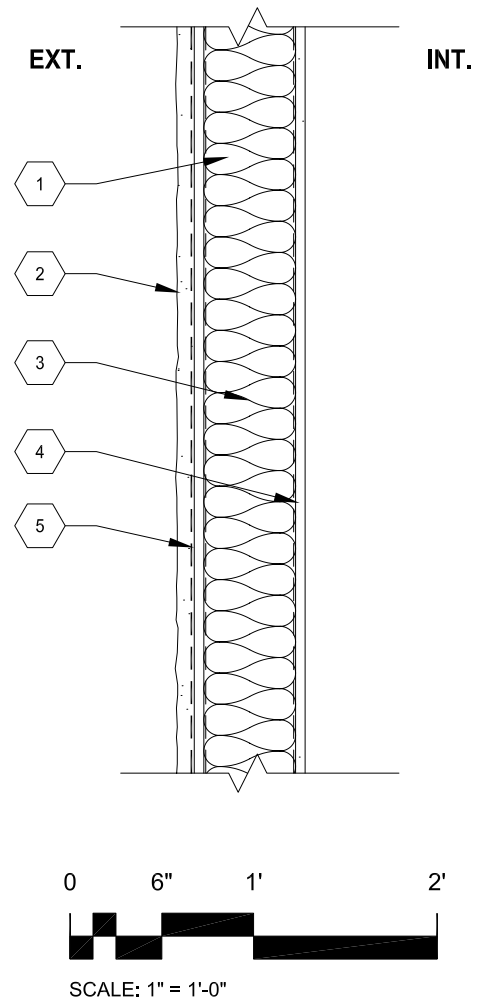

KEYNOTES:

1. Metal stud wall
2. 3-coat stucco system
3. Batt insulation
4. Gypsum board
5. Air/moisture retarder

7050-7. Gymnasium Structures

7.1. Gymnasium structures can be generally considered any space that contains athletic activities on a routine basis. The approved systems listed below provide a durable interior and exterior finish appropriate for gymnasium structures. To achieve the energy goals stated by the BIA, all of the selected systems also incorporate a high level of thermal performance similar to that recommended for school structures. Following this list are descriptions and cross sections of each of the approved exterior wall systems for gymnasiums.

7.2. Approved Exterior Wall Systems for Gymnasium Structures

- CMU wall with masonry veneer
- Insulated concrete panels
- CMU wall with insulated metal panel system
- CMU wall with stucco finish system
- Pre-engineered buildings (see below)

7.3. Pre-Engineered Buildings

7.3.1. Pre-engineered buildings may be acceptable for gymnasium structures. These will be allowed only if the gymnasium is a separate structure from the school, dormitory, or maintenance facilities. The use of pre-engineered systems for gymnasium structures must have prior approval from the BIA and if so approved, the following requirements must be met:

- 7.3.1.1. Interior finishes must be masonry up to 10 feet above the finished floor. Abuse-resistant gypsum board or metal panels are acceptable above the masonry.
- 7.3.1.2. Structural elements must be located so as not to cause hazards to the occupants. Intermediate supports not on the building perimeter will not be allowed.

**Figure 7050-7(1):
CMU Wall with Masonry Veneer**

This wall system is a cavity wall system consisting of a CMU wall and brick masonry veneer. The insulation in this system is placed within the cavity, allowing the inner CMU mass to aid in regulating changes in temperature. An air/moisture retarder (location of air/moisture retarder to be determined by local climatic conditions) is installed to minimize moisture and air migration. The interior surface of the CMU is exposed for durability.

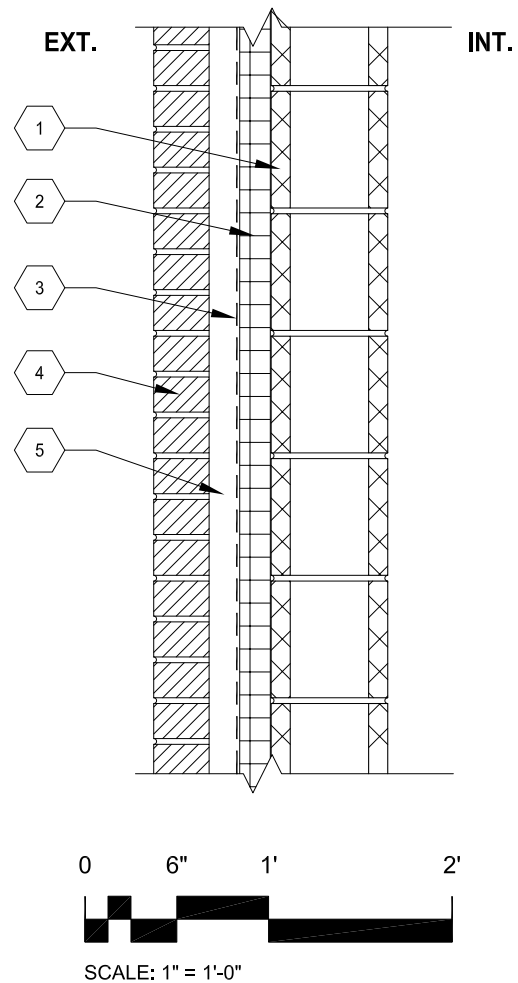

- KEYNOTES:**
1. CMU wall
 2. Rigid insulation
 3. Air/moisture retarder
 4. Masonry veneer
 5. Air space

**Figure 7050-7(2):
Insulated Concrete Panels**

This wall system is a tilt-up or precast concrete insulated panel. A layer of rigid insulation and ties are sandwiched between a structural concrete panel and a veneer face panel. The interior face of the panel shall be furred to a depth sufficient to conceal electrical and IT equipment. With prior approval of the BIA, the interior furring may be eliminated in part or in all locations. Panel sizes and thicknesses will vary depending on structural loading and workable size.

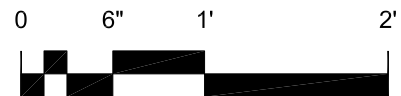
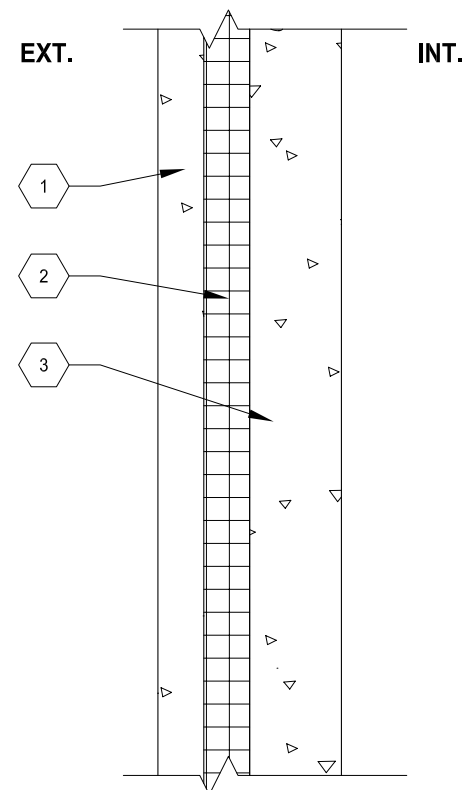

SCALE: 1" = 1'-0"

KEYNOTES:

1. Concrete face panel
2. Rigid insulation and tie system
3. Structural concrete panel

**Figure 7050-7(3):
CMU Wall with Insulated Metal Panel System**

This system consists of an insulated metal panel system applied over a single-wythe CMU wall. An air/moisture retarder (location of air/moisture retarder to be determined by local climatic conditions) is installed to minimize moisture and air migration. The thermal performance is provided by the insulated metal panels. The insulated metal panel system used may vary depending upon budget, aesthetic concerns, and constructability. The type of insulated metal panels shall be determined by the Designer of Record. Metal panel systems must be installed a minimum of 10 feet above adjacent grades. All metal panel systems must be factory finished. The interior surface of the CMU is exposed for durability.

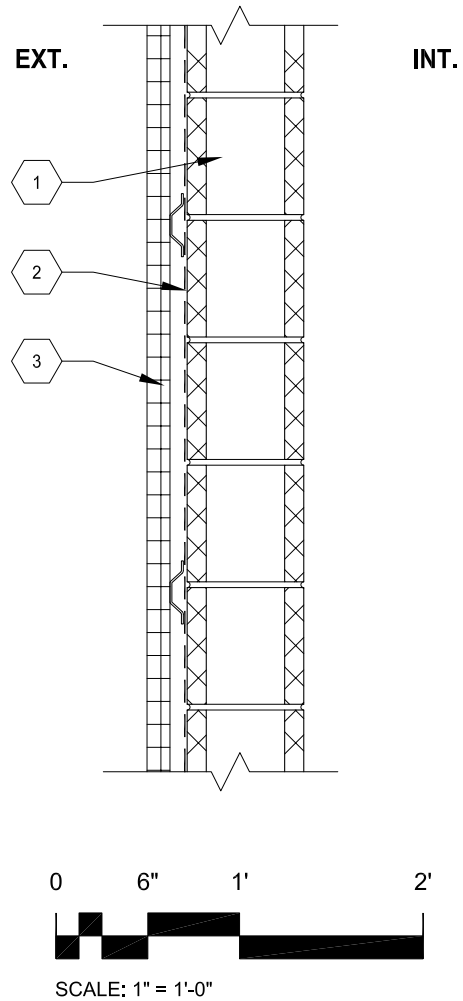

- KEYNOTES:**
1. CMU wall
 2. Air/moisture retarder
 3. Insulated metal panel system

**Figure 7050-7(4):
CMU Wall with Stucco Finish System**

This system consists of a 3-coat stucco system applied to a single-wythe CMU wall. The insulation in this system is rigid insulation applied to the exterior of the CMU wall and behind the stucco finish. This allows the mass of the CMU to aid in regulating temperature changes. An air/moisture retarder (location of air/moisture retarder to be determined by local climatic conditions) is installed to minimize moisture and air migration. The stucco should be integrally colored or cement coated; the use of acrylic finishes on the stucco is not allowed. The interior surface of the CMU is exposed for durability.

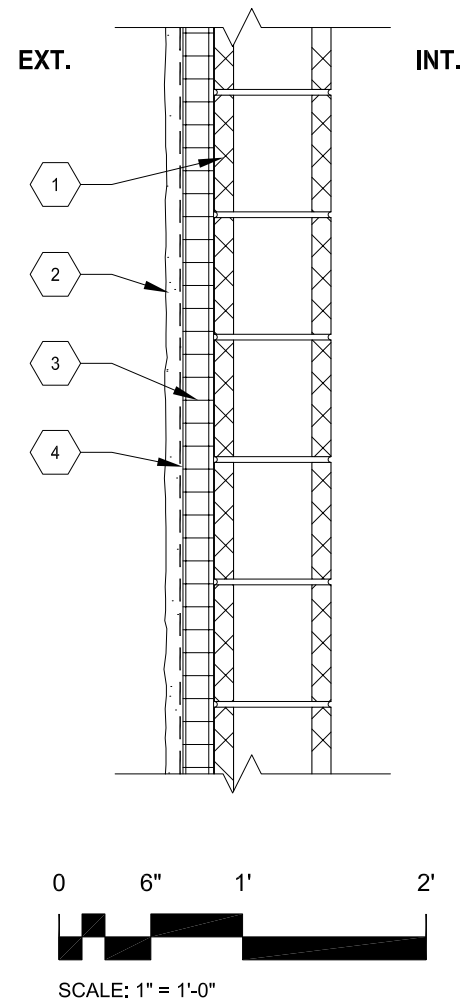

KEYNOTES:

1. CMU wall
2. 3-coat stucco system
3. Rigid insulation
4. Air/moisture retarder

7050-8. Dormitory Structures

8.1. Dormitory structures are facilities used for short- and long-term housing of students. The approved systems listed below are systems that provide a durable interior and exterior wall system. All the systems that include gypsum board finishes shall have abuse-resistant gypsum board. Following this list are descriptions and cross sections of each of the approved systems for dormitories.

8.2. Approved Exterior Wall Systems for Dormitory Structures

- CMU wall with masonry veneer
- Metal stud wall with masonry veneer
- Insulated concrete panels
- Metal stud wall with metal panel system
- CMU wall with stucco finish system
- Metal stud wall with stucco finish system

**Figure 7050-8(1):
CMU Wall with Masonry Veneer**

This wall system is a cavity wall system consisting of a CMU wall and brick masonry veneer. The insulation in this system is placed within the cavity, allowing the inner CMU mass to aid in regulating changes in temperature. An air/moisture retarder (location of air/moisture retarder to be determined by local climatic conditions) is installed to minimize moisture and air migration. The interior face of the CMU shall be furred to a depth sufficient to conceal electrical and IT equipment. Interior furring will also aid in creating a warmer and more hospitable environment. With prior approval of the BIA, the interior furring may be eliminated in part or in all locations. Interior gypsum board shall be abuse resistant.

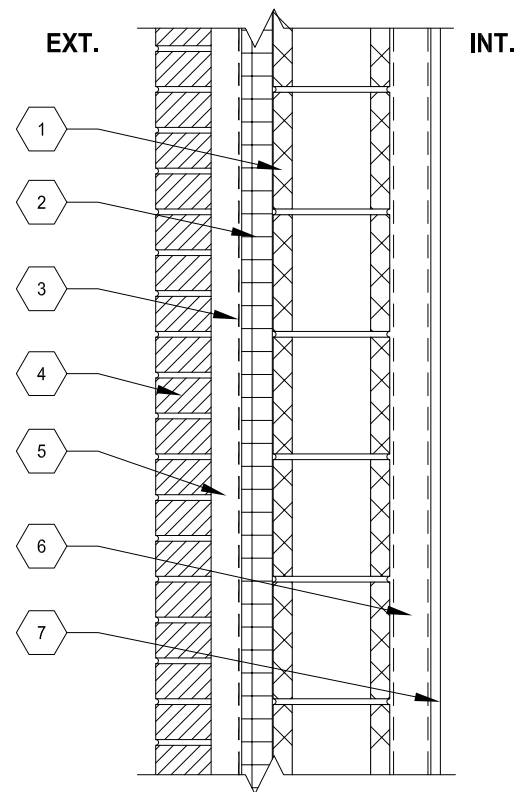

SCALE: 1" = 1'-0"

KEYNOTES:

1. CMU wall
2. Rigid insulation
3. Air/moisture retarder
4. Masonry veneer
5. Air space
6. Metal stud furring
7. Gypsum board

**Figure 7050-8(2):
Metal Stud Wall with Masonry
Veneer**

This wall system is a cavity wall system consisting of masonry veneer over stud infill or structural metal studs. The stud wall is provided with exterior wall sheathing in the cavity. An air/moisture retarder (location of air/moisture retarder to be determined by local climatic conditions) is installed to minimize moisture and air migration. A layer of rigid insulation is placed within the wall cavity to minimize thermal breaks at the studs. Additional batt insulation, if needed, is placed within the stud cavities. Interior gypsum board shall be abuse resistant.

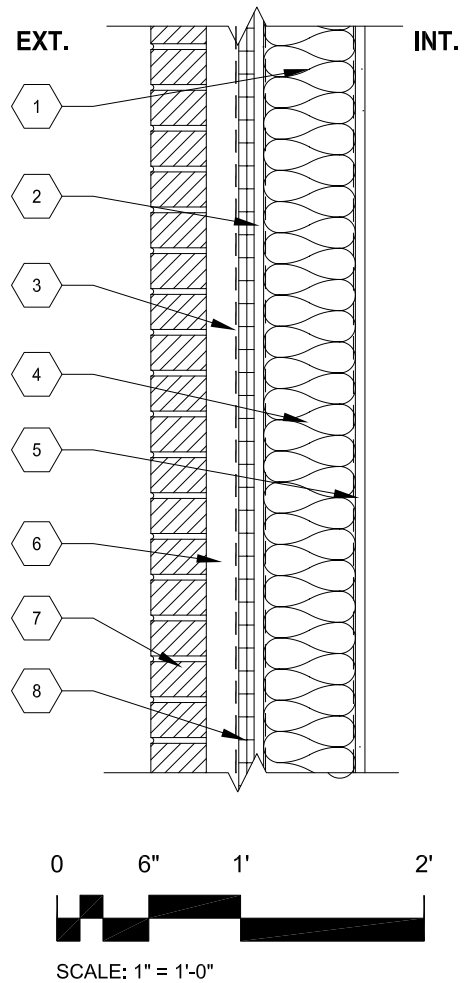

KEYNOTES:

1. Metal stud wall
2. Exterior sheathing
3. Air/moisture retarder
4. Batt insulation
5. Gypsum board
6. Air space
7. Masonry veneer
8. Rigid insulation

**Figure 7050-8(3):
Insulated Concrete Panels**

This wall system is a tilt-up or precast concrete insulated panel. A layer of rigid insulation and ties are sandwiched between a structural concrete panel and a veneer face panel. The interior face of the panel shall be furred to a depth sufficient to conceal electrical and IT equipment. With prior approval of the BIA, the interior furring may be eliminated in part or in all locations. Panel sizes and thicknesses will vary depending on structural loading and workable size. Interior gypsum board shall be abuse resistant.

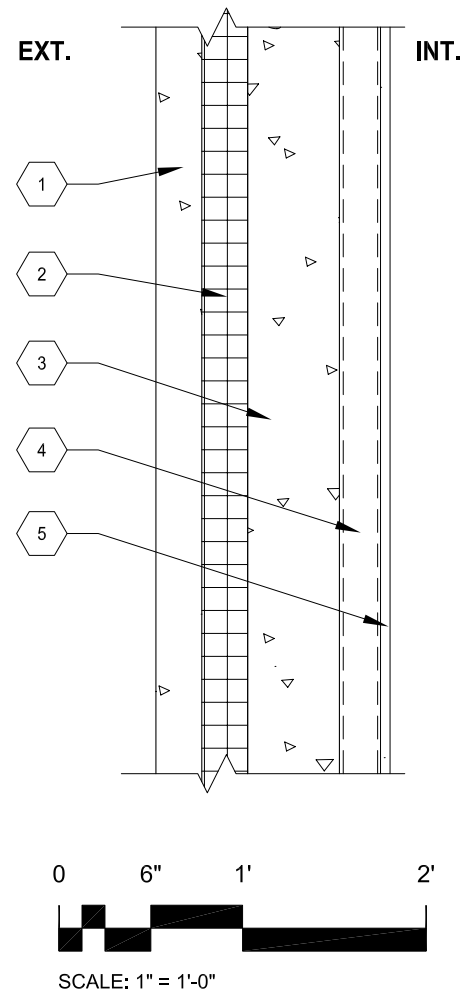

KEYNOTES:

1. Concrete face panel
2. Rigid insulation and tie system
3. Structural concrete panel
4. Metal stud furring
5. Gypsum board

**Figure 7050-8(4):
Metal Stud Wall with Metal Panel
System**

This system is a metal panel system applied over metal stud infill or structural studs. Exterior sheathing is applied to the outside face of the studs. An air/moisture retarder (location of air/moisture retarder to be determined by local climatic conditions) is installed to minimize moisture and air migration. Thermal insulation is in the form of batt insulation placed within the stud wall. Interior gypsum board shall be abuse resistant. The metal panel system used may vary depending upon budget, aesthetic concerns, and constructability. The type of metal panels shall be determined by the Designer of Record. Metal panel systems must be installed a minimum of 10 feet above adjacent grades. All metal panel systems must be factory finished.

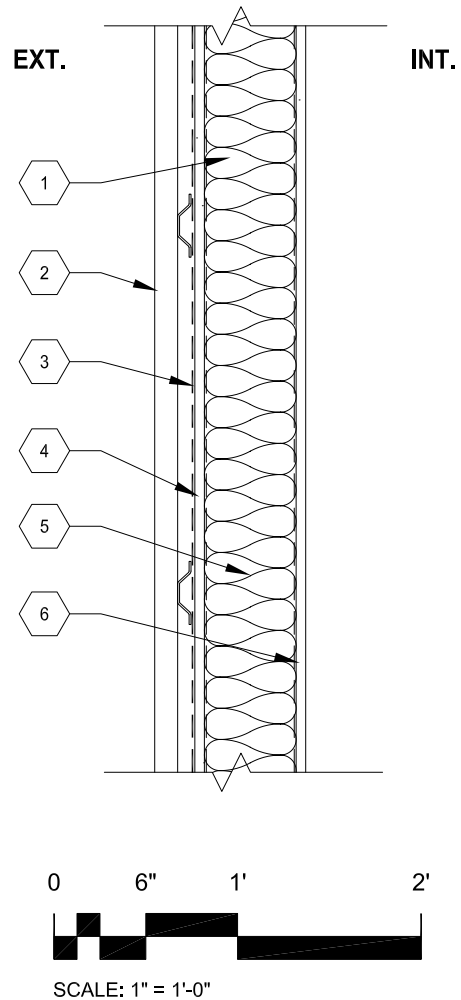

KEYNOTES:

1. Metal stud wall
2. Metal panel system
3. Air/moisture retarder
4. Exterior sheathing
5. Batt insulation
6. Gypsum board

**Figure 7050-8(5):
CMU Wall with Stucco Finish System**

This system consists of a 3-coat stucco system applied to a single-wythe CMU wall. The insulation in this system is rigid insulation applied to the exterior of the CMU wall and behind the stucco finish. This allows the mass of the CMU to aid in regulating temperature changes. An air/moisture retarder (location of air/moisture retarder to be determined by local climatic conditions) is installed to minimize moisture and air migration. The stucco should be integrally colored or cement coated; the use of acrylic finishes on the stucco is not allowed. The interior face of the CMU shall be furred to a depth sufficient to conceal electrical and IT equipment. With prior approval of the BIA, the interior furring may be eliminated in part or in all locations. Interior gypsum board shall be abuse resistant.

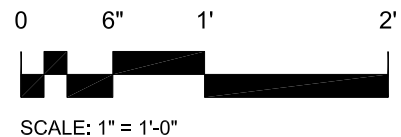
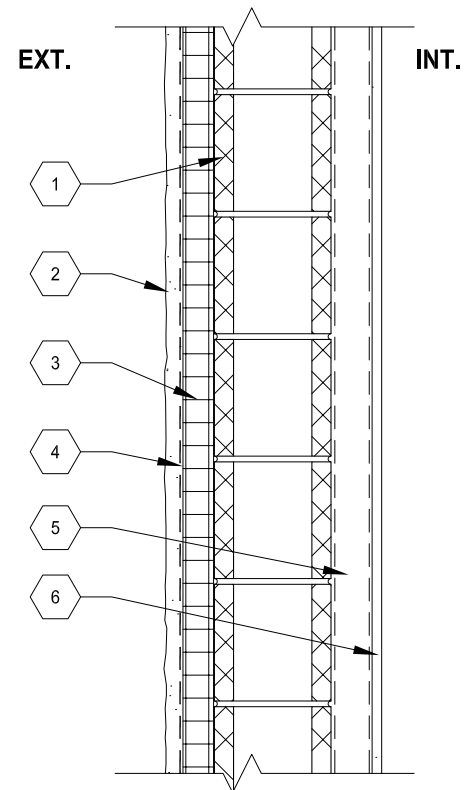

KEYNOTES:

1. CMU wall
2. 3-coat stucco system
3. Rigid insulation
4. Air/moisture retarder
5. Metal stud furring
6. Gypsum board

**Figure 7050-8(6):
Metal Stud Wall with Stucco Finish
System**

This wall system consists of a 3-coat stucco system applied to either a stud infill wall or a structural stud wall. Exterior sheathing is applied to the outside face of the studs. An air/moisture retarder (location of air/moisture retarder to be determined by local climatic conditions) is installed to minimize moisture and air migration. Batt insulation is placed within the stud wall and can be adjusted to meet regional requirements. Interior gypsum board shall be abuse resistant. The stucco system shall incorporate stucco lath over the air/moisture retarder. The stucco should be integrally colored or cement coated; the use of acrylic finishes on the stucco is not allowed.

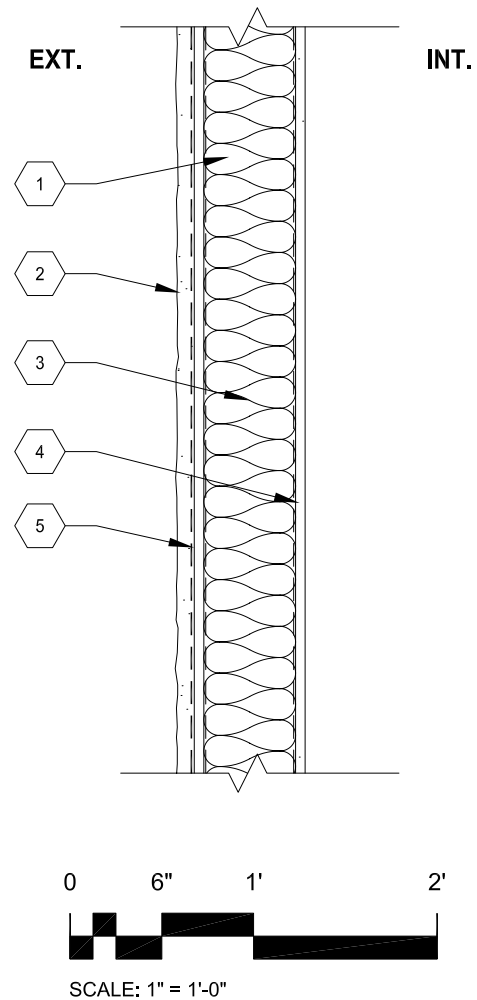

KEYNOTES:

1. Metal stud wall
2. 3-coat stucco system
3. Batt insulation
4. Gypsum board
5. Air/moisture retarder

7050-9. Maintenance Structures

9.1. Maintenance structures comprise a wide variety of facilities, including those used for maintenance shops, storage, and vehicle maintenance. The approved wall systems listed below are those that provide a durable interior and exterior system. All gypsum board in the following systems shall be abuse resistant. Following this list are descriptions and cross sections of each of the approved systems for maintenance structures.

9.2. Approved Exterior Wall Systems for Maintenance Structures

- Pre-engineered building
- Single-wythe CMU wall
- Metal stud wall with metal panel system

9.3. Pre-Engineered Buildings

9.3.1. Pre-engineered buildings offer a cost-effective solution for stand-alone maintenance structures. Pre-engineered structures must be separated from other structures on the project site.

**Figure 7050-9(1):
Single-Wythe CMU Wall**

This system is a single-wythe CMU wall with no insulation. The use of this wall type is limited to maintenance and storage structures that are not conditioned or regularly occupied.

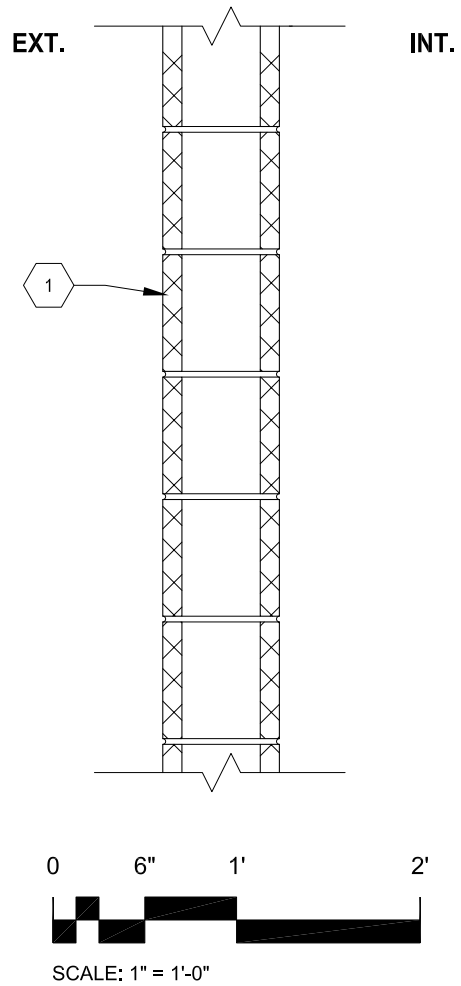

KEYNOTES:
1. CMU wall

**Figure 7050-9(2):
Metal Stud Wall with Metal Panel
System**

This system is a metal panel system applied over metal stud infill or structural studs. Exterior sheathing is applied to the outside face of the studs. An air/moisture retarder (location of air/moisture retarder to be determined by local climatic conditions) is installed to minimize moisture and air migration. Thermal insulation is in the form of batt insulation placed within the stud wall. Interior gypsum board shall be abuse resistant. The metal panel system used may vary depending upon budget, aesthetic concerns, and constructability. The type of metal panels shall be determined by the Designer of Record. Metal panel systems must be installed a minimum of 10 feet above adjacent grades. All metal panel systems must be factory finished.

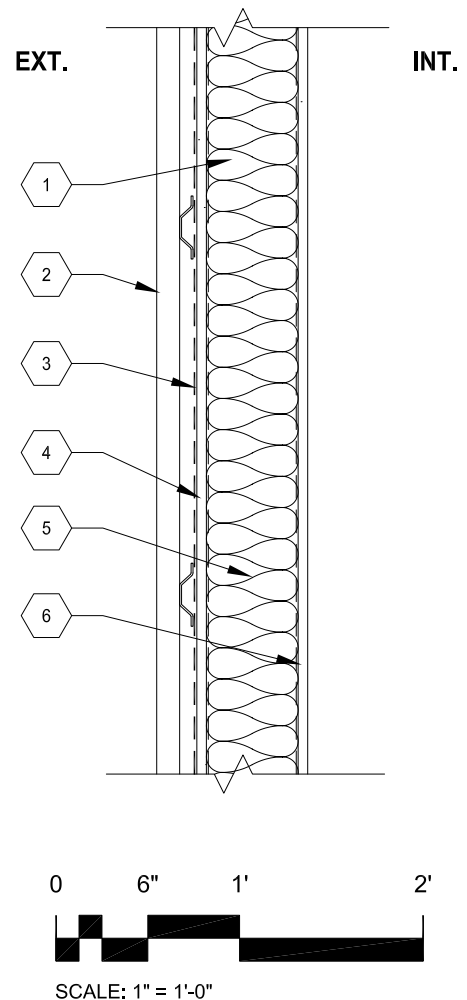

KEYNOTES:

1. Metal stud wall
2. Metal panel system
3. Air/moisture retarder
4. Exterior sheathing
5. Batt insulation
6. Gypsum board

THIS PAGE INTENTIONALLY LEFT BLANK

7060-1. General

- 1.1. Roof configurations and systems for BIA school facilities will vary between educational facilities in response to building size, design aesthetic, and local conditions. To offer the Designer of Record an appropriate selection of preselected options, roofing systems have been analyzed with a combination of specific evaluation criteria and identified as those that will meet the minimum performance criteria for BIA educational facilities.
- 1.2. For the purpose of analysis, roof systems are divided into two main categories: low-slope and steep-slope roofs. Low-slope roofs are roof systems that range from a minimum slope of 1/4 inch per foot to roofs that have a 3 in 12 pitch (a 3-inch rise in a 12-inch run). Steep-slope roofs are any roofs with a pitch greater than 3 in 12.

7060-2. Roof Systems Selection Criteria

- 2.1. When making selections for roofing systems, the Designer of Record must consider the criteria discussed in Section 7010.

7060-3. Sectional Diagrams

- 3.1. The cross-sectional diagrams presented in this section are included as diagrammatic images only. Proper placement of vapor retarders, thicknesses of insulation, roof substrates, and flashing details must be determined by the Designer of Record based on project-specific requirements.

7060-4. Design Flexibility

- 4.1. While a limited number of roofing systems that meet minimum performance requirements have been preselected by the BIA, it is intended that there be sufficient variations between those systems to allow some design freedom and flexibility. Design concepts as well as local and cultural considerations will greatly affect the systems selection process.

7060-5. Low-Slope Roof Systems

- 5.1. Low-slope roofs approved by the BIA for educational facilities consist of membrane roofs and shall meet the following conditions:
 - 5.1.1. The slope for low-slope roofs must be a minimum of 1/4 inch per foot.
 - 5.1.2. For energy performance, all low-slope roofs must be cool roofs.
 - 5.1.3. Cover boards are to be provided above the insulation for all low-slope roofs.
 - 5.1.4. All membrane roofs are to be fully adhered and should ideally slope toward the perimeter of the building.
 - 5.1.5. Where interior drains are used, consideration shall be given to eliminating potential water ponding, debris collection at the drain, etc.

5.2. The approved systems listed below are for low-slope roofing conditions. Following this list are descriptions and cross sections of each approved system for low-slope roofing conditions.

5.2.1. *Approved Systems for Low-Slope Roofs*

- Thermoplastic polyolefin (TPO) membrane roof – fully adhered
- Ketone ethylene ester (KEE) membrane roof – fully adhered

**Figure 7060-5(1):
Thermoplastic Polyolefin (TPO) –
Fully Adhered**

This system is a single-ply, fully adhered TPO membrane roof. TPO membranes are economical membranes that can be obtained in light colors to keep roofs cool. Welding of seams for TPO roofs requires more skill than do other single-ply membranes. TPO membranes have a high coefficient of expansion, so flashing details must be carefully designed and constructed. Fully adhered systems perform better in high winds than mechanically fastened or ballasted systems. Installation in cold climates can be problematic, because some adhesion can be lost when the temperature falls below recommended levels. Walkway pads to mechanical penthouses and equipment must be provided.

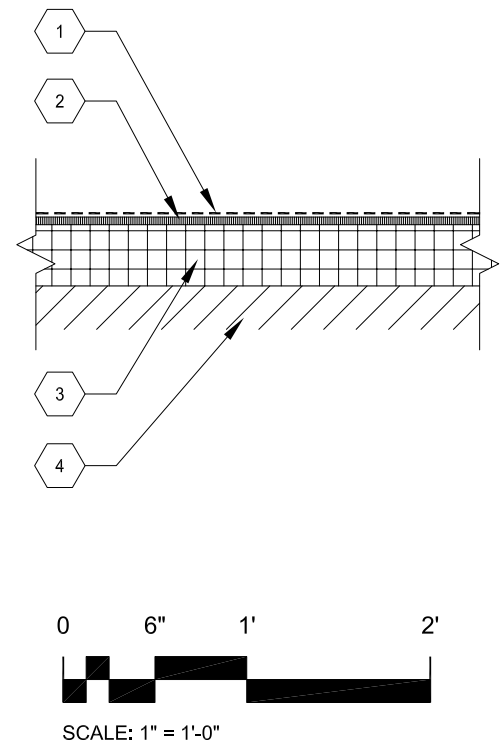

KEYNOTES:

1. Fully adhered TPO membrane
2. Cover board
3. Rigid insulation
4. Roofing substrate

**Figure 7060-5(2):
Ketone Ethylene Ester (KEE) – Fully
Adhered**

This system is a single-ply fully adhered KEE membrane roof. KEE membranes are available in light colors to keep roofs cool. Seams of KEE roofs are welded and repair is simple, requiring little special knowledge or skill. KEE roofing membranes are not as susceptible to chemical and solvent deterioration as other single-ply roofing membranes. KEE performs well in high winds because it has a durable woven layer that prevents the membrane from tearing easily. Fully adhered systems perform better in high winds than mechanically fastened and ballasted systems. Installation in cold climates can be problematic, because some adhesion can be lost when the temperature falls below recommended levels. Walkway pads to mechanical penthouses and equipment must be provided.

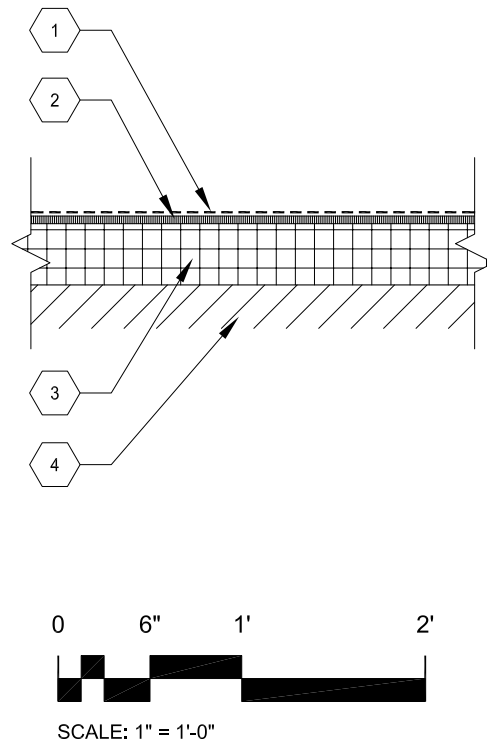

KEYNOTES:

1. Fully adhered KEE membrane
2. Cover board
3. Rigid insulation
4. Roofing substrate

7060-6. Steep-Slope Roof Systems

- 6.1.** Steep-slope roofs approved by the BIA for educational facilities consist of shingle and metal roofs and shall meet the following conditions:
- Slopes shall be a minimum of 3 units vertical in 12 units horizontal.
 - Ice and water shield shall be installed on steep-slope roofs in cold climates.
- 6.2.** The approved systems listed below shall be utilized for steep-slope roofing conditions. Following this list are descriptions and cross sections of each approved system for steep-slope roofing conditions.
- 6.2.1. *Approved Systems for Steep-Slope Roofs***
- Asphalt shingles
 - Concrete roof tiles
 - Metal roofing system

**Figure 7060-6(1):
Asphalt Shingles**

This roofing system is a steep-slope system of asphalt shingles. Asphalt shingles are available in a variety of colors, profiles, and quality levels, allowing flexibility of design and expense. Typical asphalt shingle systems are quick to install and economical solutions for steep-slope roofs. A roofing underlayment must be installed under the shingles, and an ice and water shield is required for locations that are exposed to cold and snow. Asphalt shingles are durable and have a long life expectancy. They are easily maintained and do not require a great deal of special knowledge to repair.

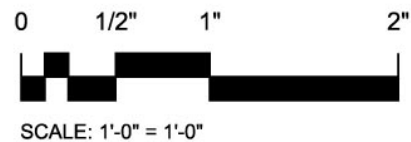
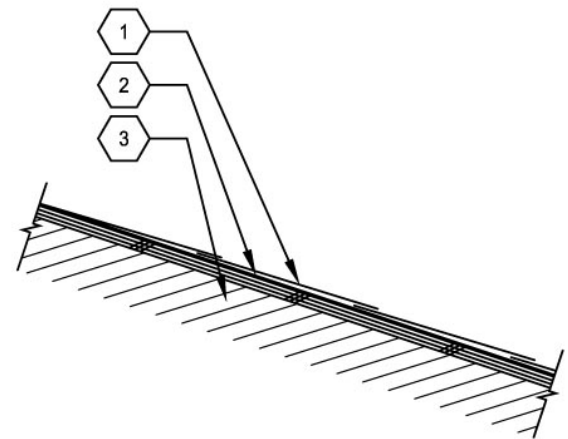

KEYNOTES:

1. Asphalt shingles
2. Roofing underlayment
3. Roofing substrate

**Figure 7060-6(2):
Concrete Roof Tiles**

This roofing system is a steep-slope system of concrete roofing tiles.

Concrete roofing tiles are available in a variety of colors and profiles, allowing flexibility of design. Concrete roof tiles can be used to mimic stone and clay roofing tiles and thus convey a greater sense of permanence than is possible with asphalt shingles. Concrete tiles are more expensive than asphalt tiles but are highly durable. Concrete tiles require wood substrates for nailing. A roofing underlayment must be installed under the tiles, and an ice and water shield is recommended for locations that are exposed to cold and snow. Concrete tiles are easily maintained and do not require a great deal of special knowledge to repair.

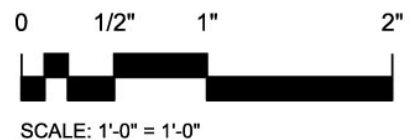
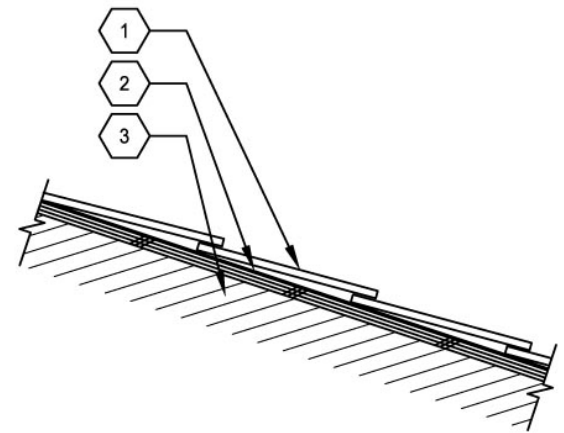
**KEYNOTES:**

1. Concrete roofing tiles
2. Roofing underlayment
3. Roofing substrate

**Figure 7060-6(3):
Metal Roofing System**

This is a metal roofing system. There are many different varieties of metal roofing systems, and it is up to the Designer of Record to determine which one is the most appropriate for a specific project. Metal roofing systems must be provided with a high-performance factory finish. A roofing underlayment must be installed under all metal roofing systems. Metal roofs are durable and have long life expectancies.

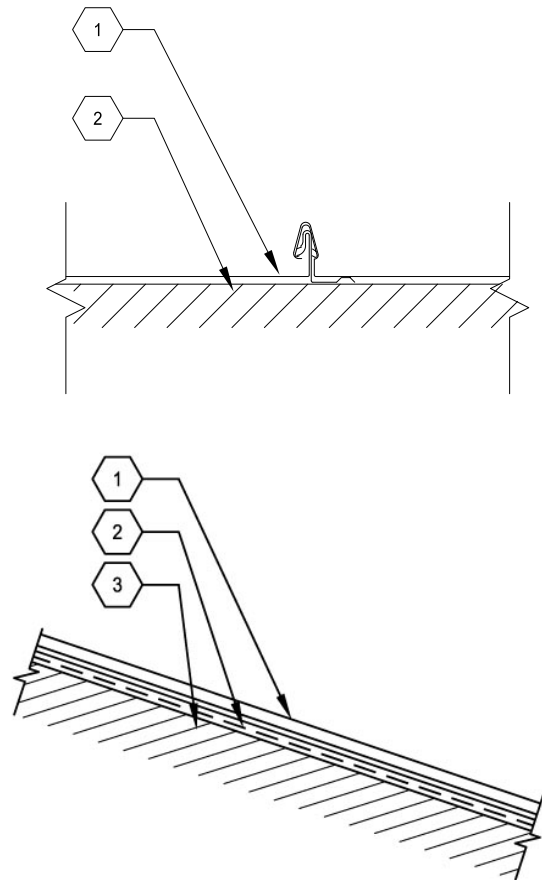

SCALE: 1'-0" = 1'-0"

KEYNOTES:

- 1. Metal roofing system
- 2. Roofing underlayment
- 3. Roofing substrate

7060-7. Roof Flashing

7.1. Roof flashings and associated components are vital to the success of the roofing system and must be carefully detailed and specified by the Designer of Record.

7.2. Standards

7.2.1. Use the *Architectural Sheet Metal Manual* produced by the Sheet Metal and Air Conditioning Contractors' National Association (SMACNA) as the standard for all roof flashing.

7.2.2. In order to qualify for roofing warranties, it is often necessary to follow manufacturers' published flashing and roofing details. The Designer of Record shall note any conflicts between typical manufacturer's details and those illustrated in the SMACNA standards and make recommendations to the BIA.

7.3. Finishes

7.3.1. Flashings for roofs shall be constructed of one of the following materials:

- Galvanized steel
- Copper
- Stainless steel
- Prefinished aluminum/steel

7.3.2. Galvanized steel flashings are not allowed when exposed to public view.

7.4. Repair

7.4.1. Flashings shall be detailed such that replacement and repair of roofs require minimum disruption to the building envelope. For example, the use of two-piece flashings and removable cap flashings makes roof replacement much easier.

THIS PAGE INTENTIONALLY LEFT BLANK

7070-1. General

- 1.1. The approved interior partition systems from which the Designer of Record may choose for BIA school facilities vary according to different building types—schools, gymnasiums, dormitories, and maintenance facilities. This collection of preapproved partition systems for these building types have been carefully chosen to assure that they meet minimum performance requirements for BIA school facilities while still allowing a measure of design freedom.

7070-2. Interior Partition Selection Criteria

- 2.1. When making selections for interior wall systems, the Designer of Record must consider the criteria discussed in Section 7010.

7070-3. Finishes

- 3.1. Interior finishes shall be highly durable, attractive, and easily maintained. Finishes for interior spaces are detailed in the space criteria sheets included in the *BIA School Facilities Space Templates* and in Chapter 8, “Interiors.”

7070-4. Sectional Diagrams

- 4.1. The cross-sectional diagrams presented in this section are included as diagrammatic images only. Fire and acoustical rating information is not shown in the diagrams; it is the responsibility of the Designer of Record to meet the levels required for specific projects.

7070-5. Design Flexibility

- 5.1. While a limited number of interior partition systems that meet minimum performance requirements have been preselected by the BIA, it is intended that there be sufficient variation between the systems to allow the designer to be creative and meet project budgets. Design concepts as well as local and cultural considerations will greatly affect the systems selection process.

7070-6. School Structures

- 6.1. Interior partitions within school structures include the walls of noncirculation spaces, such as administrative areas and classrooms, and of circulation spaces, such as corridors, hallways, and entry areas. In general, noncirculation spaces are the spaces used by students and administrative personnel when engaged in learning activities and daily work. The walls of circulation spaces must withstand a higher level of abuse than those of noncirculation spaces.
- 6.2. The approved interior partition systems listed below are grouped according to the use of each space. Following this list are descriptions and cross sections of each of the approved systems for school structures.

6.2.1. *Approved Interior Partition Systems for Noncirculation Administrative Areas*

- Metal stud framing with standard gypsum board

6.2.2. *Approved Interior Partition Systems for Noncirculation Student Spaces*

- Metal stud framing with abuse-resistant gypsum board
- Metal stud framing with standard gypsum board

6.2.3. *Approved Interior Partition Systems for Circulation Spaces*

- Concrete masonry unit (CMU) partition
- Metal stud framing with standard gypsum board and masonry veneer to 7 feet 4 inches
- Metal stud framing with abuse-resistant gypsum board

**Figure 7070-6(1):
Metal Stud Framing with Standard
Gypsum Board**

This interior partition system consists of metal stud framing with standard gypsum board on both sides. This is an economical system that provides good performance in areas not subject to high traffic and abuse. Modification flexibility is good with this system, as it allows electrical, data, etc., to be installed within the stud wall. To obtain acoustical and fire ratings it may be necessary to add layers of gypsum board, acoustical batt insulation, or resilient channels, or to increase stud size, among other modifications. The Designer of Record must determine any appropriate modifications needed to meet the acoustical and fire-resistance requirements of these guidelines and the applicable codes.

The Designer of Record must also consider building movement to avoid cracking or damage to partitions. Stud sizes and spacing will likely vary depending upon spans, acoustical requirements, and fire ratings.

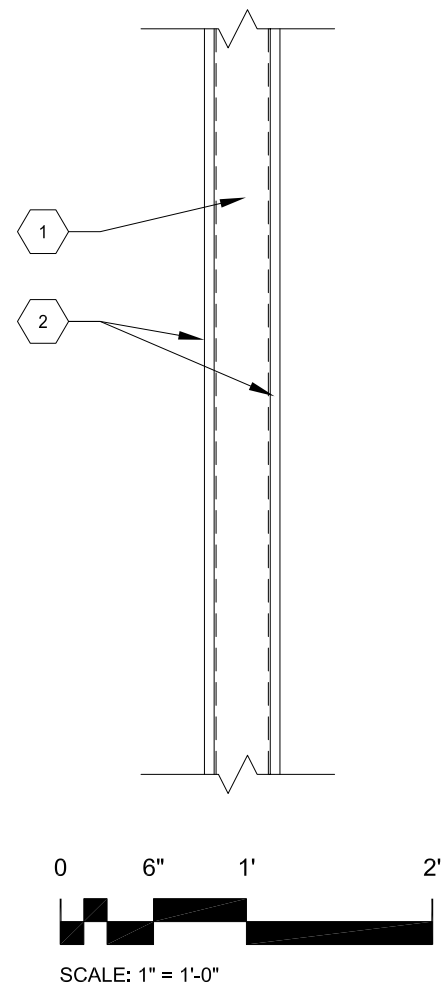

KEYNOTES:

1. Metal stud framing
2. Gypsum board

**Figure 7070-6(2):
Metal Stud Framing with Abuse-
Resistant Gypsum Board**

This interior partition system consists of metal stud framing with abuse-resistant gypsum board. This is an economical system that provides a more durable performance than standard gypsum board partitions. Abuse-resistant gypsum board has greater resistance to penetration and surface damage, and offers a higher security rating. Modification flexibility is good with this system, as it allows electrical, data, etc., to be installed within the stud wall. As with standard gypsum board partitions, the Designer of Record must determine any appropriate modifications needed to meet the acoustical and fire-resistance requirements of these guidelines and the applicable codes.

The Designer of Record must also consider building movement to avoid cracking or damage to partitions. Stud sizes and spacing will likely vary depending upon spans, acoustical requirements, and fire ratings.

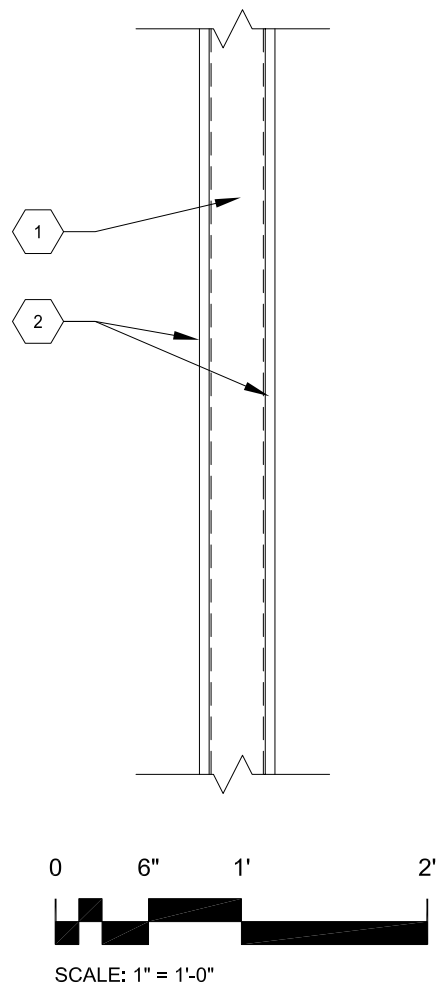

KEYNOTES:

1. Metal stud framing
2. Abuse-resistant gypsum board

**Figure 7070-6(3):
CMU Partition**

This interior partition system consists of a single-wythe CMU wall. This partition provides a high level of durability and requires little maintenance. Integral colored and ground face CMU provides a good finish and alleviates the need for maintenance of painted or coated surfaces, although durable paint finishes are also acceptable. Electrical, IT, and plumbing systems shall be recessed into the partitions. Surface mounting of these items is not permitted without BIA approval due to damage and vandalism concerns. In some instances, furring of one or both sides of CMU partitions may be considered. This is especially true when the CMU is serving as part of the structural system and the typical partitions are made of metal studs and gypsum board. As with gypsum board partitions, CMU partitions must meet the acoustical and fire-resistance requirements of these guidelines and the applicable codes.

The Designer of Record must also consider building movement to avoid cracking or damage to partitions. CMU sizes and reinforcing will likely vary depending upon building loads and fire ratings.

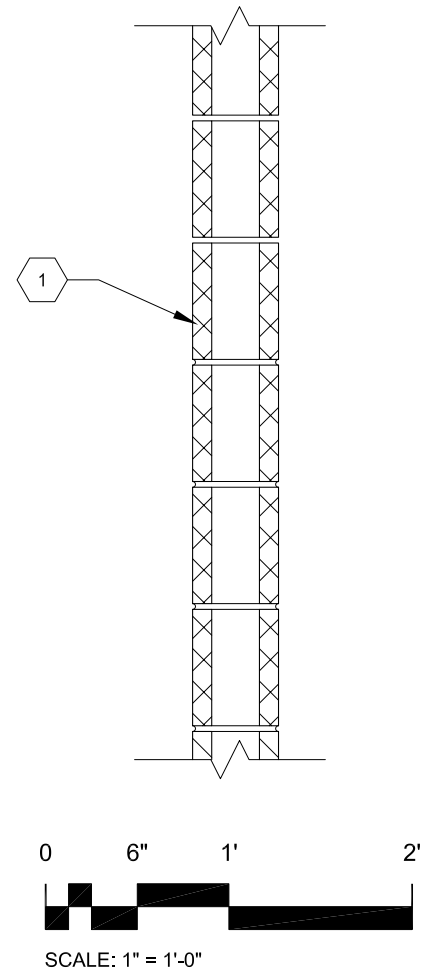

KEYNOTES:
1. CMU partition

Figure 7070-6(4)
Metal Stud Framing with Standard Gypsum Board and Masonry Veneer to 7 Feet 4 Inches

This interior partition system consists of metal stud framing with standard gypsum board and masonry veneer. This combination provides a highly durable masonry base at locations where abuse is more common. Masonry can be either clay units or CMUs. Integrally colored CMUs are preferred, although highly durable paint finishes are also acceptable. Modification flexibility is fairly good with this system, as it allows electrical, data, etc., to be installed within the stud wall, although it is more difficult to do so through the masonry base. As with CMU partitions, surface mounting of electrical, plumbing, and IT equipment is not allowed unless prior approval from the BIA is obtained. As with gypsum board and CMU partitions, the Designer of Record must determine any appropriate modifications needed to meet the acoustical and fire-resistance requirements of these guidelines and the applicable codes.

The Designer of Record must also consider building movement to avoid cracking or damage to partitions. Masonry sizes should conform to industry standard sizes and minimal width requirements to maximize use of the building space. Stud size and spacing will likely vary depending upon building loads and fire ratings.

The height of the masonry is based upon a typical door frame height. The mentioned masonry height may vary if approved by the BIA.

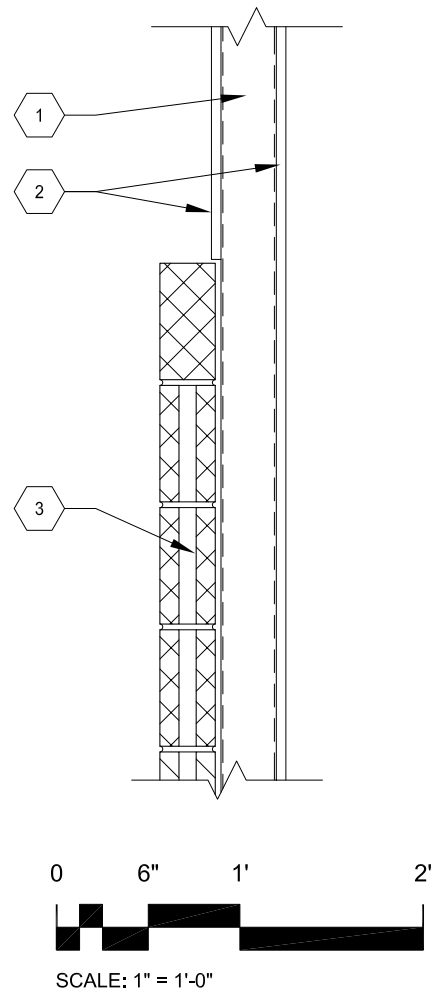

- KEYNOTES:**
1. Metal stud framing
 2. Gypsum board
 3. Masonry veneer

7070-7. Gymnasium Structures

- 7.1. Interior partitions within gymnasium areas are typically minimal, with a notable exception for locker areas.
- 7.2. As with the exterior walls of the gymnasium, interior partitions within the gymnasium and locker areas must be highly durable. Locker areas also have moisture considerations that are best addressed with CMU partitions.
- 7.3. The approved system listed below is a durable interior partition system. Following is a description and cross section of the approved system for gymnasium structures.

7.3.1. *Approved Interior Partition System for Gymnasiums*

- CMU partition

**Figure 7070-7(1):
CMU Partition**

This interior partition system consists of a single-wythe CMU wall. This partition provides a high level of durability and requires little maintenance. Integral colored and ground face CMU provides a good finish and alleviates the need for maintenance of painted or coated surfaces, although durable paint finishes are also acceptable. Electrical, IT, and plumbing systems shall be recessed into the partitions. Surface mounting of these items is not permitted without BIA approval due to damage and vandalism concerns. As with gypsum board partitions, the Designer of Record must determine any appropriate modifications needed to meet the acoustical and fire-resistance requirements of these guidelines and the applicable codes.

The Designer of Record must also consider building movement to avoid cracking or damage to partitions. CMU sizes and reinforcing will likely vary depending upon building loads and fire ratings.

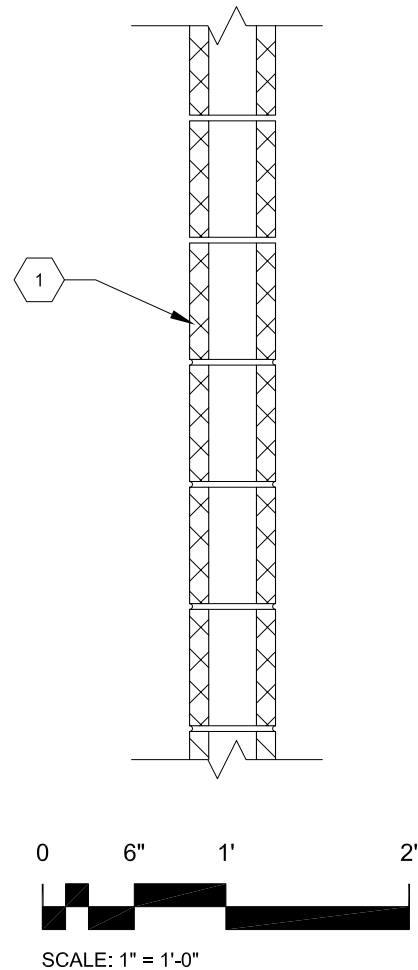

- KEYNOTES:**
1. CMU partition

7070-8. Dormitory Structures

- 8.1.** Interior partitions within dormitories comprise corridor walls, dividing walls between units, and walls within units and bathrooms. Corridor walls in dormitories are exposed, as they are in school structures, to greater traffic and require a higher level of durability. Due to the anticipated limited supervision within dormitories, walls within units and between units should also be constructed of durable materials. While CMU is the most durable and is appropriate for all dormitory spaces, gypsum board partitions create less institutional-feeling environments.
- 8.2.** The approved systems listed below are durable interior partition systems. All gypsum board partitions within dormitories must use abuse-resistant gypsum board. Following this list are descriptions and cross sections of each of the approved systems for dormitory structures.

8.2.1. *Approved Interior Partition Systems for Dormitories*

- CMU partition
- Metal stud framing with abuse-resistant gypsum board

**Figure 7070-8(1):
CMU Partition**

This interior partition system consists of a single-wythe CMU wall. This partition provides a high level of durability and requires little maintenance. Integral colored and ground face CMU provides a good finish and alleviates the need for maintenance of painted or coated surfaces, although durable paint finishes are also acceptable. Electrical, IT, and plumbing systems shall be recessed into the partitions. Surface mounting of these items is not permitted without BIA approval due to damage and vandalism concerns. In some instances, furring of one or both sides of CMU partitions may be considered. This is especially true when the CMU is serving as part of the structural system and the typical partitions are made of metal studs and gypsum board. As with gypsum board partitions, these partitions must meet the acoustical and fire-resistance requirements of these guidelines and the applicable codes.

The Designer of Record must also consider building movement to avoid cracking or damage to partitions. CMU sizes and reinforcing will likely vary depending upon building loads and fire ratings.

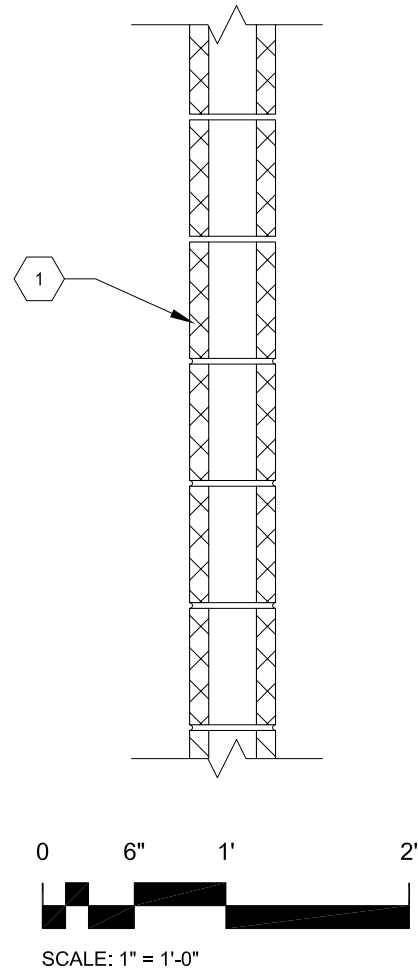

- KEYNOTES:**
1. CMU partition

**Figure 7070-8(2):
Metal Stud Framing with Abuse-
Resistant Gypsum Board**

This interior partition system consists of metal stud framing with abuse-resistant gypsum board. This is an economical system that provides a more durable performance than standard gypsum board partitions. Abuse-resistant gypsum board has greater resistance to penetration and surface damage, and offers a higher security rating. Modification flexibility is good with this system, as it allows electrical, data, etc., to be installed within the stud wall. As with standard gypsum board partitions, these partitions must meet the acoustical and fire-resistance requirements of these guidelines and the applicable codes.

The Designer of Record must also consider building movement to avoid cracking or damage to partitions. Stud sizes and spacing will likely vary depending upon spans, acoustical requirements, and fire ratings.

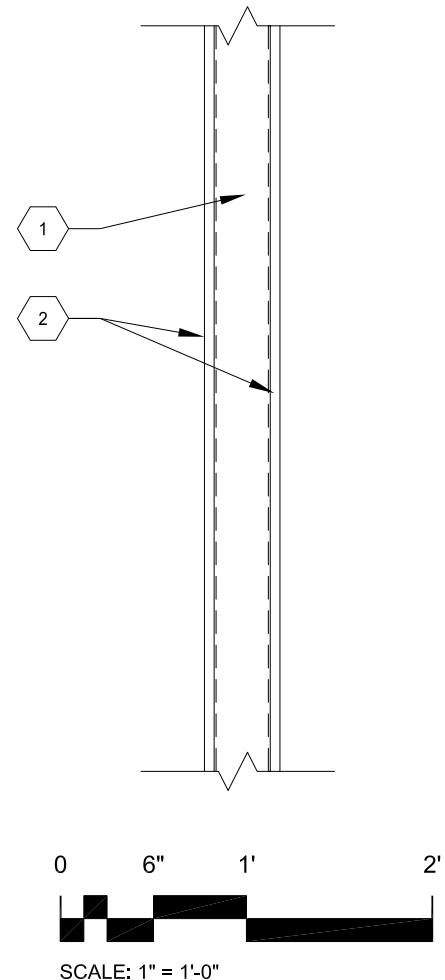

KEYNOTES:

1. Metal stud framing
2. Abuse-resistant gypsum board

7070-9. Maintenance Structures

- 9.1.** While interior partitions within maintenance facilities are limited, some maintenance facilities will house offices, restrooms, and storerooms. Maintenance facilities are subject to impact and potential interior damage due to the moving of equipment, vehicles, and materials. For this reason, interior partitions must be impact resistant.
- 9.2.** The approved systems listed below are durable interior partition systems. All gypsum board partitions within maintenance facilities must use abuse-resistant gypsum board. Following this list are descriptions and cross sections of each of the approved systems for maintenance structures.

9.2.1. *Approved Interior Partition Systems for Maintenance Structures*

- CMU partition
- Metal stud framing with abuse-resistant gypsum board

**Figure 7070-9(1):
CMU Partition**

This interior partition system consists of a single-wythe CMU wall. This partition provides a high level of durability and requires little maintenance. Integral colored and ground face CMU provides a good finish and alleviates the need for maintenance of painted or coated surfaces, although durable paint finishes are also acceptable. Electrical, IT, and plumbing systems shall be recessed into the partitions. Surface mounting of these items is not permitted without BIA approval due to concerns of damage from impact of moving equipment, vehicles, and materials. As with gypsum board partitions, CMU partitions must meet the acoustical and fire-resistance requirements of these guidelines and the applicable codes.

The Designer of Record must also consider building movement to avoid cracking or damage to partitions. CMU sizes and reinforcing will likely vary depending upon building loads and fire ratings.

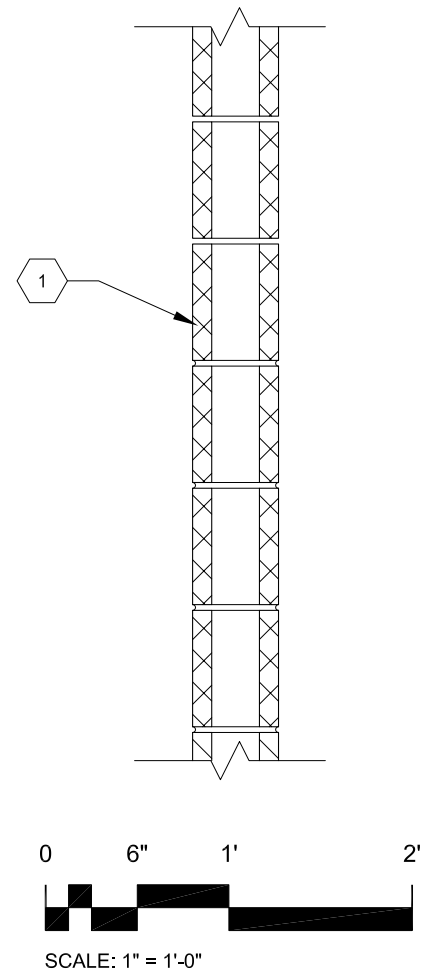

KEYNOTES:
1. CMU partition

**Figure 7070-9(2):
Metal Stud Framing with Abuse-
Resistant Gypsum Board**

This interior partition system consists of metal stud framing with abuse-resistant gypsum board. This is an economical system that provides a more durable performance than standard gypsum board partitions. Abuse-resistant gypsum board has greater resistance to penetration and surface damage, and offers a higher security rating. Modification flexibility is good with this system, as it allows electrical, data, etc., to be installed within the stud wall. As with standard gypsum board partitions, these partitions must meet the acoustical and fire-resistance requirements of these guidelines and the applicable codes.

The Designer of Record must also consider building movement to avoid cracking or damage to partitions. Stud sizes and spacing will likely vary depending upon spans, acoustical requirements, and fire ratings.

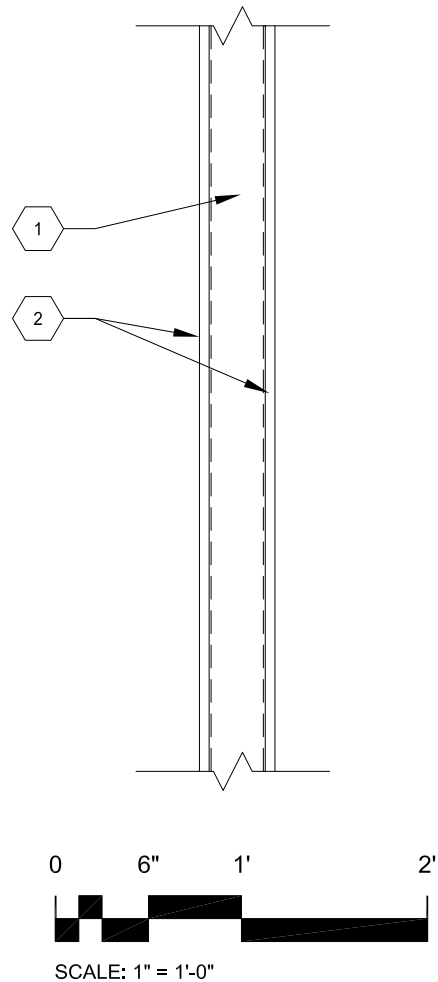

KEYNOTES:

1. Metal stud framing
2. Abuse-resistant gypsum board

7080-1. General

- 1.1. This section provides roof drainage guidelines for new BIA school facilities. Roof drainage is critical in designing low-maintenance buildings and shall be closely coordinated with the civil design to ensure proper drainage away from the building structure. Water cannot drain or pond on sidewalks where freezing occurs.

7080-2. Low-Slope Roof Drainage

- 2.1. Roofs shall be designed to provide positive drainage for all parts of the roof area. As discussed in Section 7060, the minimum acceptable roof slope is 1/4 inch per foot.
- 2.2. In designing low-slope roofs, the Designer of Record shall locate roof drains toward the perimeter of the roof whenever possible.
- 2.3. Each roof drain shall be accompanied by an overflow drain or overflow scupper to allow the roof to drain if the primary drain is not operable.
- 2.4. If storm sewer facilities exist on the site, it is preferable that the primary roof drains empty directly into the storm sewer. If the primary drain is discharged to the surface, the drain shall discharge a minimum of 10 feet from the building onto impervious material. Surface grading shall be such that no water can flow back to the structure. Overflow drains and scuppers must daylight so that it is readily apparent when a primary drain is not operable.

7080-3. Steep-Slope Roof Drainage

- 3.1. Steep-slope roofs are to be drained using a gutter and downspout system. Gutters and downspouts shall conform to the *Architectural Sheet Metal Manual* published by the Sheet Metal and Air Conditioning Contractors' National Association (SMACNA). Gutters shall be designed with an open face if icing is expected to occur.
- 3.2. If storm sewer facilities exist on the site, it is preferable that the downspouts drain directly into the storm sewer. If the downspout is discharged to the surface, the drain shall discharge a minimum of 10 feet from the building onto impervious material. Surface grading shall be such that no water can flow back to the structure.
- 3.3. Internal gutters are not allowed under any condition.

THIS PAGE INTENTIONALLY LEFT BLANK

7090-1. General

- 1.1. Thermal and moisture protection systems are integral to the performance, health, and safety of buildings. The variables that affect the design and selection of these systems for BIA school facilities must be analyzed by the Designer of Record to meet code requirements and energy and LEED goals.

7090-2. Fire Protection Systems

- 2.1. Structural building component protection, fire separation, and building penetrations must be designed to conform to the applicable codes described in these guidelines. Fire protection items are paramount in providing general life safety.
- 2.2. All fire-rated components must conform to testing and be certified by Underwriters Laboratories (UL), Warnock Hershey, or be as prescribed in NFPA 5000.
- 2.3. Penetrations through fire-rated assemblies shall be minimized to the greatest extent possible.

7090-3. Thermal Insulation

- 3.1. Thermal insulation will depend greatly upon environmental considerations for each specific project.
- 3.2. Building insulation must support the energy consumption goals of the BIA for heating and cooling.
- 3.3. Breaks in the thermal barrier should be avoided whenever possible. The Designer of Record shall provide design and details that allow for continuous insulation for all building components.
- 3.4. All fiberglass insulation shall be formaldehyde free and conform to ASTM C665 Standard Specification for Mineral-Fiber Blanket Thermal Insulation for Light Frame Construction and Manufactured Housing.
- 3.5. Rigid insulation must conform to ASTM C578 Standard Specification for Rigid, Cellular Polystyrene Thermal Insulation.

7090-4. Air Barriers

- 4.1. Air barriers are designed to prevent or reduce the flow of air through a building system. In some instances, air barriers may also serve as moisture barriers. An air barrier material must have an air permeance level of 0.004 cubic feet per minute per square foot at 1.57 pounds per square foot or less when tested in accordance with ASTM E2178 Standard Test Method for Air Permeance of Building Materials.
- 4.2. Air barriers must be continuous in order to properly work. The Designer of Record shall detail the building components such that the sealing of seams, penetrations, and openings is indicated.

- 4.3. The design of air barriers shall be closely coordinated with vapor and moisture barriers to ensure that moisture is not trapped in the building envelope.

7090-5. Vapor Retarder

- 5.1. Vapor retarders are designed to restrict the flow of water vapor through a material. Generally, these are placed on the warm side of the insulation. The Designer of Record shall coordinate the location of the vapor barrier with the mechanical designer, because in some climates, a vapor retarder may not be necessary. Vapor barriers shall be 1.0 perm or less when tested with ASTM E96 Standard Test Methods for Water Vapor Transmission of Materials.
- 5.2. Vapor retarders must be continuous. Penetrations, perimeters, and openings through vapor retarders must be sealed to maintain the vapor retarder envelope.

7090-6. Moisture Barrier

- 6.1. Moisture barriers, also known as drainage planes, are designed to prevent the bulk flow of water from such sources as rain and condensation into the building.
- 6.2. Moisture barriers shall be continuous with sealed joints, seams, penetrations, and openings. Flashing shall be incorporated into moisture barrier systems to allow any moisture to escape the wall system.
- 6.3. The design of moisture barriers shall be closely coordinated with vapor retarders and air barriers to ensure that moisture is not trapped in wall assemblies. In some cases, moisture barriers may also be used as air barriers.

7090-7. Flashing

- 7.1. Flashing systems are vital to the integrity of the moisture protection system; the Designer of Record shall take great care when specifying and detailing flashing systems.

7.2. Standards

- 7.2.1. Use the *Architectural Sheet Metal Manual* produced by the Sheet Metal and Air Conditioning Contractors' National Association (SMACNA) as the standard for all roof flashing.
- 7.2.2. The Designer of Record shall note any conflicts between typical manufacturer's details and those illustrated in the SMACNA standards and make recommendations to the BIA.

7.3. Finishes

- 7.3.1. Flashings shall be constructed of one of the following materials:

- Galvanized steel
- Copper
- Stainless steel
- Prefinished aluminum/steel

- 7.3.2. Galvanized steel flashings are not allowed when exposed to public view.
- 7.3.3. Flashing in contact with earth shall be stainless steel.
- 7.3.4. Flashing shall be designed with a slope so that water cannot pond. Slopes must be away from the building except for cap flashings, which should slope toward the roof.

THIS PAGE INTENTIONALLY LEFT BLANK

7100-1. General

- 1.1. Glazing systems consist of interior and exterior windows and entrance and storefront systems. The information in this section represents a standard of acceptable quality for glazing system components for BIA school facilities.
- 1.2. In new construction, when operable interior or exterior windows are provided in any residential or non-residential accessible space, as practical for the architectural design, at least one such window shall be arranged for use by disabled adult occupants, including staff. This window's operable parts shall be within ADAABAAG reach range criteria.

7100-2. Exterior Windows

- 2.1. To the extent possible, windows should be standard manufactured sizes. Custom-size windows should be used sparingly.
- 2.2. A minimum of one window per classroom will be operable. Provide insect screening on all operable windows.
- 2.3. Operable sashes shall not project into pedestrian paths.
- 2.4. Windows in food prep areas shall not be operable.
- 2.5. Window construction is to be aluminum and shall meet the following standards and criteria:
 - ANSI/American Architectural Manufacturers Association (AAMA) Heavy Commercial (HC) Class.
 - 6063 aluminum, T5 or better, with a minimum .125-inch extrusion wall.
 - Standard anodized finish.
 - ANSI/AAMA AW-50 rating or better.
 - Cut edges shall be deburred. Sharp edges and protruding screws are prohibited.
 - Window extrusions shall be of thermal break design.
 - Corner joints are to be flush, mitered, rigid, and weatherproof. Joints are to be hairline joints.
 - Windows shall drain internally and externally to the building exterior. Provide weeps in the frame so all water can escape the frame.
 - Window frames must be reinforced at hardware locations.
 - Fasteners throughout are to be stainless steel.
 - Hardware shall be institutional grade and vandal resistant.
- 2.6. Window manufacturers must have a minimum of 10 years experience manufacturing the specified window type.
- 2.7. Weather stripping shall not be exposed when windows are shut. All windows must be provided with appropriate weather stripping:

- For compression type weather stripping, nonferrous spring metal or vinyl gasket
- For sliding type weather stripping, woven pile wool, polypropylene, or nylon

7100-3. Interior Windows

- 3.1. When detailing and specifying interior windows, the Designer of Record must consider fire rating and student safety.
- 3.2. Interior window frames are to be steel hollow metal. The frames shall have anchors compatible with the partition system in which they are installed.
- 3.3. If interior windows are to be fire rated, the preferred method is to use fire-rated glass and frames. The use of wire glass is discouraged. Interior windows must conform to the following standards:
 - NFPA 80 Standard for Fire Doors and Other Opening Protectives
 - Underwriters Laboratories (UL) certification
- 3.4. Provide either tempered or laminated safety glass where required by code.

7100-4. Entry and Storefront Systems

- 4.1. The Designer of Record shall use standard manufactured systems when detailing and specifying storefront and entry systems.
- 4.2. It is preferable that major building entries be constructed of heavy-duty aluminum with ample vision glass for proper supervision.
- 4.3. Curtain-wall glazing systems are not allowed.
- 4.4. Storefront and entry systems shall be aluminum and shall meet the following requirements:
 - 4.4.1. Systems shall meet AAMA standards where information is not specifically called out in this section.
 - 4.4.2. Extrusions shall be a minimum of .188-inch-thick 6063-T5 or -T6 aluminum.
 - 4.4.3. Reinforcing must be provided at hardware locations.
 - 4.4.4. Stiles shall be a minimum of 2 inches thick; narrow stiles are not allowed.
 - 4.4.5. Corners shall be constructed with concealed welded reinforcement brackets.
 - 4.4.6. Aluminum shall have a standard anodized finish.
 - 4.4.7. There shall be center mullions at all double doors.

7100-5. Glass

- 5.1. Glazing properties are an integral part of the design of low-energy-use buildings and are highly dependent on climate zone and the design of the building and its

systems. While building design variables cannot be quantified in a design standards document, climate zones can be. Therefore, the recommended glazing properties are specific to each of the seven climate zones described in the *National Best Practices Manual for Building High Performance Schools*, published by the U.S. Department of Energy.

- 5.2. Although these values should be considered minimum standards, they may be adjusted for individual projects if the Designer of Record can demonstrate that, due to the design of the building and/or building systems, additional energy savings can be achieved by doing so.
- 5.3. Figure 7100-1 outlines the recommended glazing properties for the BIA design standards. These values are based upon exceeding ASHRAE 90.1 requirements by approximately 30 percent.

Figure 7100-1: Recommended Glazing Properties

Climate Zone ¹	Description	Representative City	ASHRAE Climate Zone ²	Property	Maximum Value ^{3,4}
1	Hot & humid	Orlando	2A	U-Value	fixed 0.94 operable 0.98
				SHGC	all 0.17 north 0.44
2	Temperate & humid	Atlanta	3A	U-Value	fixed 0.42 operable 0.47
				SHGC	all 0.19 north 0.26
3	Cool & humid	Boston	5	U-Value	fixed 0.42 operable 0.47
				SHGC	all 0.26 north 0.36
4	Cold & humid	Minneapolis	6A	U-Value	fixed 0.42 operable 0.47
				SHGC	all 0.26 north 0.38
5	Hot & dry	Phoenix	2B	U-Value	fixed 0.94 operable 0.98
				SHGC	all 0.17 north 0.44
6	Cool & dry	Denver	5B	U-Value	fixed 0.42 operable 0.47
				SHGC	all 0.26 north 0.36
7	Temperate & mixed	Seattle	4C	U-Value	fixed 0.42 operable 0.47
				SHGC	all 0.25 north 0.36

Notes:

1. Climate zones are as established in the *National Best Practices Manual for Building High Performance Schools*, published by the U.S. Department of Energy.
2. Corresponding ASHRAE climate zone for representative city from ASHRAE 90.1 Energy Standard for Buildings Except Low-Rise Residential Buildings.
3. *U-Value* = thermal conductance (Btu/hr-sf-F), *SHGC* = Solar Heat Gain Coefficient (unitless), *fixed* = fixed window, *operable* = operable window, *all* = all orientations except north, *north* = north orientation.

- 5.4. In addition to energy-use goals, each project will also have certain aesthetic and design objectives. Consequently, it is the responsibility of the Designer of Record to make the final determination of glass type within the framework of these guidelines. In order to achieve these goals, the following considerations apply:
- 5.4.1. Exterior glass shall meet the minimum performance criteria shown in Figure 7100-1. Glass criteria shall be analyzed in conjunction with the building envelope for overall energy performance of the building. Exterior glazing shall be, at minimum, 1-inch insulated units.
 - 5.4.2. Special performance-enhancing coatings shall be considered. Glazing types for each building will be limited to two types for ease of maintenance.
 - 5.4.3. Spandrel glass will be insulated units with the coating on the #3 surface.
 - 5.4.4. All glass in and around doors as well as locations specified in the code shall be tempered or laminated safety glass.

7100-6. Flashing

- 6.1. Flashing systems are vital to the integrity of the moisture protection system; the Designer of Record shall take great care when specifying and detailing flashing systems.
- 6.2. Flashing at windows shall be provided with an upturned leg on the interior of the window. Such flashings will also incorporate end dams.
- 6.3. Where flashing over masonry without precast or cast stone sills, continuous sheet metal flashing shall extend the full depth of the masonry and turn down. Unflashed masonry sills are not allowed.

6.4. Standards

- 6.4.1. Use the *Architectural Sheet Metal Manual* produced by the Sheet Metal and Air Conditioning Contractors' National Association (SMACNA) as the standard for all roof flashing.
- 6.4.2. The Designer of Record shall note any conflicts between typical manufacturer's details and those illustrated in the SMACNA standards and make recommendations to the BIA.

6.5. Finishes

- 6.5.1. Flashings shall be constructed of one of the following materials:
 - Galvanized steel
 - Copper
 - Stainless steel
 - Prefinished aluminum/steel

- 6.5.2.** Galvanized steel flashings are not allowed when exposed to public view.
- 6.5.3.** Flashing in contact with earth shall be stainless steel.
- 6.5.4.** Flashing shall be designed with a slope so that water cannot pond. Slopes must be away from the building except for cap flashing, which should slope toward the roof.

7110-1. Introduction

- 1.1. This section provides an overview of daylighting strategies that can be incorporated into the design of BIA school facilities. Daylight can be provided via windows and glazed doors, as well as via clerestories and other forms of toplighting. These glazed openings are collectively referred to as “fenestration.” The placement, design, and selection of materials for fenestration are extremely important and can make the difference between a high-performance and low-performance building. Fenestration impacts building energy efficiency by affecting cooling loads, heating loads, and lighting loads. Visual comfort is strongly affected by window location, shading, and glazing materials. Well-designed windows can be a visual delight. But poorly designed windows can create a major source of glare. Thermal comfort can also be compromised by poor fenestration design.

7110-2. Benefits of Daylighting

- 2.1. There are several advantages to the use of daylight in schools. Daylight contributes to:
 - Academic performance
 - Energy savings
 - Better light
 - Connection to nature
 - Improved health
 - Environmental education

7110-3. Basic Daylighting Principles

- 3.1. These six principles should be followed when designing daylit school facilities:
 - Prevent direct sunlight penetration into glare-sensitive teaching spaces.
 - Provide gentle, uniform light throughout each space.
 - Avoid creating sources of glare.
 - Allow teachers to control the daylight with operable louvers or blinds.
 - Design the electric lighting system to complement the daylighting design, and encourage maximum energy savings through the use of lighting controls.
 - Plan the layout of interior spaces to take advantage of daylight conditions.

7110-4. Daylighting Strategies

- 4.1. The following are acceptable daylighting strategies that may be incorporated in the design of school facilities:

4.1.1. *Sidelighting*

- 4.1.1.1. Sidelighting allows daylight to enter through windows in vertical walls. With windows, uniform illuminance is more difficult to provide, because there is always more light next to the window. Glare is also more difficult to control. But there are design techniques that can substantially reduce problems associated with sidelighting.
- 4.1.1.2. The depth of daylighting penetration from vertical windows is largely dependent on the height of the window head. For a simple sidelighting scheme, a rough rule of thumb is that usable daylight will be available about 1½ times the window head height. So for good daylight delivery, sidelighting windows should be located as high as possible in the wall. However, to provide exterior views, windows need to be at eye level. Since these requirements clearly conflict, advanced daylighting designs differentiate between the functions of view and task daylighting, frequently providing separate windows for each.
- 4.1.1.3. The orientation of a sidelighting aperture strongly affects the quantity, quality, and distribution of daylight. For sidelighting and no shading, north-facing windows provide the most even illuminance. The quantity of light is diminished, but a larger aperture will compensate, providing adequate and more even illumination.
- 4.1.1.4. Whenever possible, orient view windows toward the north or south to avoid low-angle east/west sun. Up to 15 degrees variance from true north or south is acceptable, but will reduce performance.
- 4.1.1.5. Angled ceilings in classrooms used in combination with high sidelighting will bring daylight farther back into the room. Careful integration of the structural system, HVAC ducts, and lighting in the plenum space is required.

4.1.2. *Exterior Shading Devices*

- 4.1.2.1. Shading devices for sidelighting strategies minimize solar gains and glare, and can also be designed to increase illumination levels. Shading devices—both overhangs and fins—can be either opaque or translucent, and solid or louvered. It is best to place shading devices outside the glazing to stop solar gains before they hit the window and to reduce potential glare from bright window views.
- 4.1.2.2. Exterior overhangs should be deep enough to minimize direct sun on the window for the hottest hours of the day during the cooling

season. For south-facing windows in sunny (clear sky) climates with very high air-conditioning loads, a good rule of thumb is to design the overhang with a shading cutoff angle about equal to 90 degrees minus the site latitude. This provides full shading between March 21 and September 21. Overhangs for climates with lower air-conditioning loads and/or more summer overcast can increase this angle by 5 to 15 degrees. Overhangs or fins for windows facing east or west do not lend themselves to simple rules of thumb and should be carefully designed for the specific site, climate, and space. North-facing windows usually do not need exterior overhangs or finish, but may occasionally require interior blinds or louvers to control glare.

4.1.3. *Interior Shading Devices*

- 4.1.3.1. Interior shading devices for windows reduce solar heat gain somewhat but are most effective at controlling glare. The most common interior glare control devices are horizontal mini-blinds, vertical blinds, shade screens, and curtains.

4.1.4. *Toplighting*

- 4.1.4.1. Providing daylight from above, generically referred to as “toplighting,” can generally create the most uniform illumination throughout a space. Examples of toplighting strategies include roof monitors and tubular skylights. Roof monitors must utilize vertical or high-slope glazing. South facing vertical glazing tends to be the most efficient in terms of optimizing yearly heating and cooling balance.
- 4.1.4.2. Unit skylights utilizing multiple pieces of glazing are *not permitted* under these guidelines. Due to long-term maintenance concerns and the potential for leakage, these systems are not allowed.
- 4.1.4.3. Small, single-opening skylights are permitted. These can be installed in patterns to create even, low-glare illumination across a large area.
- 4.1.4.4. Tubular skylights for use in areas with relatively deep roof cavities are permitted.
- 4.1.4.5. All toplighting schemes represent penetrations through the roof diaphragm, which is often a critical part of the building’s structural system. Similarly, toplighting apertures may intersect with HVAC ducting, electrical lighting layouts, and fire sprinkler systems. Careful coordination of the structural, mechanical, and electrical designs will ensure compatibility among these systems.

THIS PAGE INTENTIONALLY LEFT BLANK

7120-1. General

- 1.1. Because doors in educational facilities are subject to a great amount of use and possible abuse, they must be durable and low maintenance. This section will discuss the types of doors suitable for BIA school facilities and establish the door criteria to be considered and met by the Designer of Record.

7120-2. Fire Ratings

- 2.1. All rated doors and frames must meet the requirements of the following:
 - NFPA 80 Standard for Fire Doors and Other Opening Protectives
 - Underwriters Laboratories (UL)
- 2.2. All rated doors and frames must be provided with fire labels.

7120-3. Interior Doors

- 3.1. Two main interior door types will be used in BIA educational facilities—general use doors and service doors.
 - 3.1.1. General use doors include those leading into offices, classrooms, dormitory rooms, restroom facilities, and other locations used for non-service and equipment use. The following considerations apply to general use doors:
 - General use doors shall be solid core wood. Wood doors should be finished with a light-color stain so as not to show scratches and abrasions.
 - Vision panels are required on doors in schools leading into public spaces. These allow for safe entry and exit as well as observation. Vision panels in dorm rooms are not required. The glass in the vision panel must be tempered or laminated safety glass.
 - Steel frames are to be used for all general use doors.
 - 3.1.2. Service doors are those that lead into service and equipment areas, such as mechanical rooms, kitchens, custodial rooms, etc. The following considerations apply to service doors:
 - Service doors shall be hollow metal steel.
 - All service doors shall have steel frames.

7120-4. Exterior Doors

- 4.1. Exterior doors typically comprise public entrances and service entry doors.
 - 4.1.1. Preferably, public entry doors should be heavy-duty storefront entry systems. The requirements for storefront entry systems are covered in Section 7100.

- 4.1.2. Service entry doors for such spaces as mechanical rooms, storage spaces, and receiving areas are to be painted steel. All service entry doors must have steel frames.

7120-5. Steel Doors

- 5.1. Typical steel doors shall be ANSI A250.8/SDI-100 Recommended Specifications for Standard Steel Doors and Frames Level 3 Heavy Duty with 16-gauge faces.
- 5.2. Doors subject to heavy use shall be ANSI A250.8/SDI-100 Level 4 Extra Heavy Duty with 14-gauge faces.
- 5.3. For light-duty doors such as in-room closets, ANSI A250.8/SDI-100 Level 1 Standard Duty doors with 18-gauge faces are permitted.
- 5.4. Doors shall be 1¾ inches thick and flush type.
- 5.5. Doors shall be of fully welded construction.
- 5.6. Doors shall be factory reinforced and prepared for hardware attachment.
- 5.7. Standard size doors are preferable.
- 5.8. Exterior doors must be galvanized.
- 5.9. Steel doors are to be factory primed with rust inhibitive primer.

7120-6. Wood Doors

- 6.1. Doors must meet ANSI/Window & Door Manufacturers Association (WDMA) I.S. 1A Industry Standard for Architectural Wood Flush Doors.
- 6.2. Doors shall be Architectural Woodwork Institute (AWI) Quality Standards Extra Heavy Duty grade.
- 6.3. Doors shall be provided with a clear factory finish.
- 6.4. Doors shall be 1¾ inches thick and flush type.
- 6.5. Provide matching edge banding.
- 6.6. Face veneer must be:
 - Premium grade
 - Plain cut
 - Vertical grain
 - Slip matched
 - 1/50 inch minimum thickness
- 6.7. Wood doors are not allowed for exterior uses under any circumstance.

7120-7. Frames

- 7.1. Exterior frames shall be ANSI A250.8/SDI-100 Level 4 (14 gauge).
- 7.2. Interior frames shall be ANSI A250.8/SDI-100 Level 3 (16 gauge).
- 7.3. Frames shall have continuous welded mitered corners.
- 7.4. Frames shall be factory reinforced and prepared for door hardware.
- 7.5. Frames shall be factory primed with rust inhibiting primer.
- 7.6. Knockdown frames are not permitted.
- 7.7. Provide frame anchors to tie into adjacent construction per Steel Door Institute (SDI) standards.
- 7.8. Frames against masonry or concrete are to be slush filled.

7120-8. Hardware

- 8.1. Door hardware shall conform to Builders Hardware Manufacturers Association (BHMA) standards.
- 8.2. Door hardware shall be Grade 1, heavy duty, and vandal resistant.
- 8.3. Finishes shall be BHMA standard finish.
- 8.4. Door hardware design and mounting heights will conform to the accessibility standards.
- 8.5. Coordinate keying with the BIA.

THIS PAGE INTENTIONALLY LEFT BLANK

7130-1. General

- 1.1. Signage systems provide a safe and clear way to navigate through a building structure. Many types of signage are dictated by the accessibility guidelines and codes specified in this handbook. Exiting signs are discussed in Chapter 11, “Electrical.”

7130-2. Coordination

- 2.1. The Designer of Record shall include a signage schedule meeting the requirements of this section. It is important for the Designer of Record to coordinate signage locations, materials, colors, and numbering system with the BIA to ensure desirable results. The Designer of Record shall number the rooms on the plans to correspond to the eventual actual room numbers, and try to ensure that existing room signage would not require modification if the building were expanded.

7130-3. Locations

- 3.1. Signage shall be located where required by NFPA 5000 and the adopted accessibility codes discussed in Section 1040. Signage locations include but are not limited to restrooms, accessible entries, and locations of vertical circulation. At exits and elevators serving accessible space, but not providing approved accessible means of egress, install signage indicating the location of accessible means of egress. Install intermittent signage as needed to positively locate accessible exits.
- 3.2. Exterior building identification signage shall be provided. These signs can be either stand-alone or building-mounted systems. If the signage is building mounted, it shall conform to the following:
 - Finished aluminum
 - 10-inch-high letters
 - Helvetica medium font
- 3.3. Signage shall be provided at each room entry. This room identification sign shall be coordinated with the fire alarm system and building plans and shall have the following information:
 - Room name
 - Room number
- 3.4. Site signage, other than signs required by code, shall be installed to aid in site circulation. Such signage shall be located in all locations where a clear and concise message is needed for wayfinding. Locations for signage not required by code shall include, but not be limited to, the following:
 - Bus drop-off zones
 - Drop-off zones for parents

- Separated or restricted parking areas
- Directional signage for special building components

7130-4. Sign Construction

- 4.1. Signage systems should be durable and vandal resistant.
- 4.2. Room identification signs shall have flexible/removable inserts in permanent fixed frames. The signs shall be provided with a slot for the insertion of occupant or program identification.
- 4.3. Signs shall be 1/4-inch thick, integrally colored solid acrylic plastic.
- 4.4. For raised characters (tactile), letter height shall be not less than 1/32-inch thick. These characters can be etched, routed, or pin-mounted.
- 4.5. Die-cut characters shall be cut from vinyl film and applied to the face of acrylic plastic.
- 4.6. Provide Grade II Braille lettering.
- 4.7. Provide lettering in contrasting levels to meet accessibility standards.

7130-5. Installation

- 5.1. Install signage at heights and locations required to meet accessibility standards.
- 5.2. Install signage per manufacturer's recommended methods.

7140-1. General

- 1.1. Training related to elevator maintenance and evacuating mobility impaired persons shall be conducted or arranged by the building contractor. The following shall be used as a guideline for each project.
 - 1.1.1. The elevator contractor shall train local personnel in care, adjustment, and maintenance of elevator equipment immediately following acceptance of the system.
 - 1.1.2. Training will include evacuation of persons entrapped in elevators, including mobility impaired persons, and those trapped on upper floors, for example at areas of refuge, during emergency conditions. Coordinate this training with the local fire department.
 - 1.1.3. Written documentation that successful training on evacuating mobility impaired persons was accomplished shall be submitted through the Contracting Officer to the Division of Safety and Risk Management (Authority Having Jurisdiction).

THIS PAGE INTENTIONALLY LEFT BLANK

8000-1. Introduction

- 1.1. This chapter, in conjunction with the *BIA School Facilities Space Templates*, provides guidelines for developing attractive and effective building interiors for all new BIA schools. The design of BIA school interiors shall be in conformance with these guidelines unless exceptions to them are granted by the BIA.
- 1.2. Educational facilities must be durable, perform well acoustically, provide a healthy environment, and be easy and economical to maintain. To that end, their design should be based upon recognized and sound commercial building practices.
- 1.3. Refer to Chapter 1, “General Information,” and Chapter 2, “Presentation of Data,” for required documents, drawing and specifications formats, and other design and submittal requirements not discussed in this chapter.
- 1.4. Additional design and submittal requirements may apply for projects with unusual or highly technical criteria.
- 1.5. As applicable, the Designer of Record shall incorporate the sustainability strategies identified in Chapter 3, “LEED Goals and Guidelines.”
- 1.6. The guidelines in this chapter should be used in conjunction with those in the other chapters in this handbook, and the Designer of Record should coordinate with the other project consultants to be sure all aspects of the school facility are effective and compatible.
- 1.7. All design features must be weighed carefully for their initial cost, long-term maintenance cost and needs, durability, and their impact on the environment.

8000-2. Content

- 2.1. The following sections present the considerations to analyze before final selection of interior elements. These guidelines are not meant to unduly limit the design process; rather, they are intended to ensure a consistent level of quality for all facilities.

8000-3. Compliance Requirements

- 3.1. It is recognized that not all design professionals will agree with the choice of the interior systems and materials discussed and presented in this chapter and in the space templates. However, the items included have been identified through comprehensive performance evaluations and meet the goals of the BIA for their educational facilities. Consequently, the Designer of Record is required to use the specified systems and materials unless permission to do otherwise is stated in the following sections or in the *BIA School Facilities Space Templates*.

THIS PAGE INTENTIONALLY LEFT BLANK

8010-1. Role of the Designer of Record in Systems Selection

- 1.1. While the guidelines in this chapter and in the *BIA School Facilities Space Templates* present a selection of preapproved interior finish systems, it is ultimately the responsibility of the Designer of Record to determine which of the preapproved systems is most appropriate for any given project. The Designer of Record must analyze the various considerations included within the individual systems sections to make final recommendations to the BIA. It is not the role of the Designer of Record to analyze components outside of the preapproved systems unless allowed elsewhere in this chapter or in the space templates to do so.

8010-2. Considerations

- 2.1. This chapter and the space criteria sheets in the space templates volume provide the Designer of Record with a menu of approved interior finish systems that meet the BIA performance standards. In most cases, the Designer of Record will have more than one option to select from.
- 2.2. These guidelines recognize that many variables exist, depending upon market conditions, regional considerations, and design concepts. In selecting interior finish systems, considerations for the Designer of Record to analyze include, but are not limited to:
- First costs
 - Lifetime costs
 - Expected system life
 - Maintenance
 - Durability
 - Local availability
 - Local expertise
 - Local tribal customs and heritage
 - LEED compliance
 - Energy and resource conservation
 - Climate
 - Schedule
 - Acoustics
 - Aesthetics
 - Fire ratings

THIS PAGE INTENTIONALLY LEFT BLANK

8020-1. General

- 1.1. For the design of interiors, follow all applicable current codes, standards, and laws. For a more general list of codes and standards that apply to BIA educational facilities, refer to Chapter 1, “General Information.” During design, report any required deviations from codes and standards to the Contracting Officer.
- 1.2. Where two codes, standards, or laws are applicable to the topic under review, use the more conservative or more stringent. Consult with the BIA Office of Facilities Management and Construction (OFMC) to resolve any questions or conflicts regarding application of codes and standards.
- 1.3. NFPA 5000 Building Construction and Safety Code is the primary code to be followed.

8020-2. Applicable Codes and Standards

- 2.1. The design criteria shall also comply with the guidelines published by or contained in the following:
 - American National Standards Institute (ANSI) S12.60 Acoustical Performance Criteria, Design Requirements, and Guidelines for Schools
 - ANSI/American Society of Mechanical Engineers (ASME) A17.1 Safety Code for Elevators and Escalators
 - Americans with Disabilities Act and Architectural Barriers Act Accessibility Guidelines (ADAABAAG)
 - National Fire Protection Association (NFPA) 13 Standard for the Installation of Sprinkler Systems
 - Occupational Safety & Health Administration (OSHA)
 - U.S. Green Building Council’s Leadership in Energy and Environmental Design (LEED) program
 - U.S. Public Health Service (PHS) *Food Service Sanitation Manual*

THIS PAGE INTENTIONALLY LEFT BLANK

8030-1. General

- 1.1. Wall finishes in BIA educational facilities are required to be durable and cost effective and create a pleasing and healthy educational environment. Considerations for the selection of finish materials are listed in Section 8010.

8030-2. Working with the Space Criteria Sheets

- 2.1. The *BIA School Facilities Space Templates* volume contains space criteria sheets for all major spaces that may be required in BIA school facilities. The space criteria sheets show a group of acceptable finish materials for each space. Each of the materials listed has been deemed acceptable by the BIA and determined to meet necessary quality, durability, and functional requirements. It is the role of the Designer of Record to analyze and select a finish material from the given list that is most appropriate for the project at hand. The range of materials listed is intended to provide the designer with a limited freedom to express a design aesthetic as well as local and regional influences.

8030-3. LEED Coordination

- 3.1. Finish materials and methods shall be investigated and chosen by the Designer of Record to help achieve the BIA's Leadership in Energy and Environmental Design (LEED) objectives as outlined in Chapter 3.

8030-4. Acoustics

- 4.1. Acoustics play a major role in healthy and effective educational environments. The Designer of Record shall ensure that the acoustical performance requirements described in Section 7040 are met. In many cases this will impact the choice of finish materials.
- 4.2. In spaces with no ceilings and that are consequently exposed to structure, the Designer of Record shall perform an acoustical analysis to confirm acoustical performance as required by this handbook. In some cases, acoustical design strategies such as acoustical structural decking, batts, or baffles may be required. The Designer of Record will have final responsibility to meet acoustical requirements.

THIS PAGE INTENTIONALLY LEFT BLANK

8040-1. General

- 1.1. Corridor design is critical to efficient and safe circulation throughout school facilities. The design of corridors will vary depending upon the grade levels housed in the building.

8040-2. Corridor Width

- 2.1. The minimum width for primary corridors in elementary schools is 8 feet clear.
- 2.2. The minimum width for primary corridors in middle schools is 10 feet clear.
- 2.3. The minimum width for primary corridors in high schools is 12 feet clear.
- 2.4. The width of primary corridors should not restrict to below the required clearance at any point.
- 2.5. The Designer of Record shall analyze code requirements and traffic loads to determine minimum corridor widths in nonprimary corridors.
- 2.6. In all cases, corridor widths shall conform to code-related exiting requirements.

8040-3. Corridor Finishes

- 3.1. Finishes for both dormitory and school corridors shall be durable and require little maintenance. Approved finishes for floors, walls, and ceilings for both dormitories and schools are listed below.

3.1.1. Floors

- Carpet
- Sheet vinyl/linoleum
- Vinyl composition tile (VCT)
- Sealed concrete

3.1.2. Walls

- Painted concrete masonry units (CMUs)
- Ground face/integrally colored CMUs
- Painted standard gypsum board
- Painted abuse-resistant gypsum board

3.1.3. Ceilings

- Painted gypsum board
- Acoustical lay-in tile system

THIS PAGE INTENTIONALLY LEFT BLANK

9000-1. Introduction

- 1.1. This chapter provides structural design criteria, requirements, and guidance for all new BIA school projects. The design shall be in conformance with these guidelines unless exceptions to them are granted by the BIA.
- 1.2. Refer to Chapter 1, “General Information,” and Chapter 2, “Presentation of Data,” for required documents, drawing and specifications formats, and other design and submittal requirements not discussed in this chapter.
- 1.3. Additional design and submittal requirements may apply for projects with unusual or highly technical criteria.
- 1.4. As applicable, the Designer of Record shall incorporate the sustainability strategies identified in Chapter 3, “LEED Goals and Guidelines.”
- 1.5. The guidelines in this chapter should be used in conjunction with those in the other chapters in this handbook, and the Designer of Record should coordinate with the other project consultants to be sure all aspects of the school facility are effective and compatible.
- 1.6. All design features must be weighed carefully for their initial cost, long-term maintenance cost and needs, durability, and their impact on the environment.

9000-2. Personnel Qualifications

- 2.1. Structural engineers designing or performing structural evaluations for BIA projects must be licensed and qualified by education and relevant experience. All documents must meet professional engineering standards and be stamped by a professional engineer registered in the state of the project.

THIS PAGE INTENTIONALLY LEFT BLANK

9010-1. All Structures

- 1.1. Consider the following factors in the selection of structural and building enclosure systems for all BIA school facilities:
 - 1.1.1. Life-cycle costs, safety, durability, constructability, availability of materials, and aesthetic considerations.
 - 1.1.2. Total initial cost, including materials costs, transportation costs, and labor costs.
 - 1.1.3. Constructability, including speed of construction and impact on project construction schedule, simplicity of construction, the number of trades required to build the structure, and the required interaction among trades. Fewer structural trades are preferred.
 - 1.1.4. Structural performance, including load capacity, span range, deflection, vibration, and acoustics.
 - 1.1.5. Local availability of construction materials.
 - 1.1.6. Local expertise, including knowledge, experience, and expertise with construction materials and methods.
 - 1.1.7. Local construction season. Where local conditions exist that limit the length of the construction season, consider using construction practices that will allow for rapid completion of the building (road restrictions, for example, may prevent truck hauling during the spring thaw). These practices include prefabricated construction and structural systems that can be erected over the winter.
 - 1.1.8. Building systems accommodation, including mechanical, electrical, and plumbing systems; capability of supporting mechanical equipment; and accommodation of conduit and ductwork routing, lighting, ceilings, moving partitions, and other hung loads.
 - 1.1.9. Structural durability, including corrosion, decay, and abuse. Consider maintenance and expected system life.
 - 1.1.10. Flexibility for future modifications, including mechanical equipment; floor, roof, and wall openings; future hung partitions; future increased loading; and future adjacent additions.
 - 1.1.11. Fire resistance, including combustibility of the structural system, fire rating of the structural system, and other materials that may be required to achieve the required fire rating. Use structural systems that achieve the required construction type and fire resistance required by the building code.
 - 1.1.12. Self-weight, with respect to foundations and seismic loads.
 - 1.1.13. Structural depth, with respect to floor-to-floor height and building envelope thickness.

1.1.14. Leadership in Energy and Environmental Design (LEED) compliance, to maximize LEED points.

9010-2. Schools

2.1. Consider the following factors in the selection of systems for schools:

- Large, open, column-free spaces for the gymnasium, cafeteria, auditorium, and possibly library
- Acoustics
- Vibration from footfall
- Flexibility for future renovations and modifications

9010-3. Dormitories

3.1. Consider the following factors in the selection of systems for dormitories:

- Durability relative to student abuse, to reduce maintenance
- Acoustic transmission through floors and walls

9010-4. Maintenance Facilities

4.1. Consider the following factors in the selection of systems for maintenance facilities:

- Anchoring lightweight structures for wind uplift
- Large doors
- Durability of floor slab and walls
- Support of equipment
- Materials handling

9020-1. General

- 1.1. Design all structural elements in accordance with all applicable current codes, standards, and laws. For a more general list of codes and standards that apply to BIA educational facilities, refer to Chapter 1, “General Information.” During design, report any required deviations from codes and standards to the Contracting Officer.
- 1.2. Where two codes, standards, or laws are applicable to the topic under review, use the more conservative or more stringent. Consult with the BIA Office of Facilities Management and Construction (OFMC) to resolve any questions or conflicts regarding application of codes and standards.
- 1.3. NFPA 5000 Building Construction and Safety Code is the primary code to be followed.
- 1.4. The Designer of Record shall be responsible for the adequacy, economy, and serviceability of all structures for which they are assigned design responsibility. Good engineering judgment shall be used in addition to compliance with all applicable codes.

9020-2. Applicable Codes and Standards

- 2.1. The design criteria shall comply with the guidelines contained in the following:
 - American Concrete Institute (ACI) 302.1R *Guide for Concrete Floor and Slab Construction*, ACI 318 *Building Code Requirements for Structural Concrete and Commentary*, and ACI 360R *Design of Slabs on Ground*
 - American Institute of Steel Construction (AISC) Design Guide 3 *Serviceability Design Considerations for Steel Buildings* and Design Guide 11 *Floor Vibrations Due to Human Activity*
 - American Iron and Steel Institute (AISI) Standard for Cold-Formed Steel Framing – Lateral Design
 - American National Standards Institute (ANSI)/American Society of Mechanical Engineers (ASME) A17.1 Safety Code for Elevators and Escalators
 - American Society of Civil Engineers (ASCE) 7 *Minimum Design Loads for Buildings and Other Structures* (use the edition referenced by NFPA 5000)
 - Applied Technology Council (ATC) Design Guide 1 *Minimizing Floor Vibration*
 - Federal Emergency Management Agency (FEMA) 361 *Design and Construction Guidance for Community Shelters*
 - Metal Building Manufacturers Association (MBMA) *Metal Building Systems Manual*

- National Fire Protection Association (NFPA) 5000 Building Construction and Safety Code
- Occupational Safety & Health Administration (OSHA) Part 1926 Safety and Health Regulations for Construction

9020-3. Local Practices

- 3.1. The codes and requirements herein take precedence over local and tribal codes or laws. The exception to this is local jurisdiction requirements for snow loads and wind speed, which shall be used if larger than those required by NFPA 5000. Other local design practices that are of special interest include local foundation systems, commonly used structural systems and materials, and accommodations for temperature range.

9020-4. Design Loads

- 4.1. All loads shall be determined according to NFPA 5000 and ASCE 7. All dead, live, snow, wind, seismic, soil, temperature, rain, and ice loads shall be shown on the design drawings.

4.2. Dead Loads

- 4.2.1. In classrooms, administrative areas, kitchens, etc., design the structure above using at least 10 pounds per square foot hung load for ceilings, lights, and mechanical loads.
- 4.2.2. In mechanical rooms and mechanical penthouses, design the structure above using 25 pounds per square foot hung load for piping and equipment, in addition to specific mechanical equipment loads.
- 4.2.3. In the auto shop, metal shop, wood shop, and other shop areas where equipment may be hung from the structure above, include point loads imposed from such equipment.
- 4.2.4. In gyms, include loads imposed from basketball goals. Include vertical and horizontal point load effects from these goals.
- 4.2.5. Moveable walls must be supported from the structure above. Use the weight provided by the manufacturer. Consider the concentrated effects of the wall in its stacked position. The stiffness of the supporting structure shall be compatible with the clearance at the base of the wall.
- 4.2.6. For structures supporting mechanical equipment, design for 125 percent of the operating weight of the equipment to account for possible equipment substitutions during construction and future equipment replacement or modifications. Mechanical penthouses require a concrete floor for acoustics and a concrete housekeeping pad under the equipment for maintenance. Include the weight of the concrete pad in the dead load.

4.3. Live Loads

- 4.3.1. Minimum live loads shall be determined according to ASCE 7.
- 4.3.2. For interstitial spaces and penthouses, use a minimum live load of 40 pounds per square foot (and a 1,000-pound point load) in the spaces around the equipment.

4.4. Snow Loads

- 4.4.1. Determine snow loads in accordance with ASCE 7.
- 4.4.2. In regions of high variability as shown on the ASCE 7 map, obtain snow load information from local building officials.
- 4.4.3. Consider unbalanced snow load, snow drifts at lower roofs and projections, roof valley snow drifting, ice dams, and sliding snow as appropriate, in accordance with ASCE 7. New roofs shall not be built adjacent to existing lower roofs without structural modifications to the existing lower roof to avoid overloading the existing roof with drifted snow.

4.5. Wind Loads

- 4.5.1. Determine wind loads in accordance with ASCE 7.
- 4.5.2. In special wind regions as shown in ASCE 7, obtain wind load information from local building officials.
- 4.5.3. In hurricane-susceptible regions, schools and dormitories need *not* be designed as designated hurricane shelters.
- 4.5.4. In tornado-prone regions, tornado shelters are required in schools, subject to written direction by the BIA. The BIA will evaluate this on a case-by-case basis. Tornado-prone regions include those in Zones III and IV, and hurricane-susceptible regions are as shown in Figure 2-2 in FEMA 361. Tornado shelters shall be sized for the occupant load of the school. Design of tornado shelters shall be in accordance with FEMA 361. See Figure 9020-1.

4.6. Seismic Loads

- 4.6.1. Determine seismic loads in accordance with ASCE 7.

4.7. Soil Loads

- 4.7.1. Soil loads acting on the structure shall be obtained from the recommendations provided by the geotechnical engineer. Each project shall be provided with a geotechnical report from the BIA.

4.8. Temperature Loads

- 4.8.1. Structures shall be designed for thermal effects, including expansion and contraction of structural and nonstructural components.

4.9. Rain Loads

- 4.9.1. Determine rain load in accordance with ASCE 7.
- 4.9.2. Ponding instability shall be prevented.
- 4.9.3. Intentional ponding on the roof for detention purposes is not allowed.

4.10. Ice Loads

- 4.10.1. Ice-sensitive structures, such as guy wires, shall be designed for ice loads in accordance with ASCE 7.

9020-5. Material-Specific Requirements

- 5.1. All material-specific structural requirements are described in NFPA 5000, Chapters 41 through 45, and the appropriate material-specific codes and standards referenced by NFPA 5000.
- 5.2. The following exceptions, modifications, and exclusions are made to NFPA 5000:
 - 5.2.1. *Section 41.6.2* – The slab-on-ground minimum thickness shall be 4 inches.
 - 5.2.2. *Section 41.8* – Gypsum concrete shall not be permitted for structural use in BIA facilities.
 - 5.2.3. *Chapter 43* – Unreinforced masonry shall not be permitted for use.
 - 5.2.4. *Chapter 43* – The use of masonry below grade is permitted only if the underground space is unoccupied. All masonry below grade shall be solid grouted with open-end units. See Figure 9020-2.
 - 5.2.5. *Chapter 43* – Reinforced masonry shall be specified with the following minimum reinforcement requirements: Vertical reinforcement of at least 0.2 square inches in cross-sectional area shall be provided at corners, within 16 inches of each side of openings, within 8 inches of each side of movement joints, within 8 inches of the ends of walls, and at a maximum spacing of 10 feet. Reinforcement adjacent to openings need not be provided for openings smaller than 16 inches in either the horizontal or vertical direction, unless the spacing of distributed reinforcement is interrupted by such openings. Horizontal joint reinforcement shall consist of at least two wires of W1.7 spaced not more than 16 inches, or bond beam reinforcement shall be provided of at least 0.2 square inches in cross-sectional area spaced not more than 10 feet. Horizontal reinforcement shall also be provided at the bottom and top of wall openings and shall extend not less than 24 inches nor less than 40 bar diameters past the opening; continuously at structurally connected roof and floor levels; and within 16 inches of the top of walls.
 - 5.2.6. *Chapter 45* – Light frame wood construction is not permitted. Glue-laminated timber construction, laminated timber decking, and structural wood sheathing are permitted.

9020-6. Quality Assurance

- 6.1. A quality assurance program is required for all structures. The Designer of Record shall define the observations, special inspections, tests, and other procedures that provide an independent record to the BIA and the Designer of Record that the construction is in general conformance with the approved construction documents.
- 6.2. Quality assurance procedures, inspections, and testing shall be as stated in NPFA 5000, Chapter 40, with the following clarifications:
 - 6.2.1. The “owner” shall be the Bureau of Indian Affairs (BIA).
 - 6.2.2. The “authority having jurisdiction” shall be the Bureau of Indian Affairs Division of Safety and Risk Management.
 - 6.2.3. Inspection and testing agencies shall be hired by and paid for by the BIA.
- 6.3. **Geotechnical Certification Letter**
 - 6.3.1. Provide to the BIA a letter of certification stamped and signed by the project Designer of Record, stating that the foundation design meets the stated requirements herein and complies with the recommendations of the project geotechnical report.

Figure 9020-1: Tornado-Prone Regions (from FEMA 361)



Figure 9020-2: Open-End Concrete Masonry Unit (CMU)

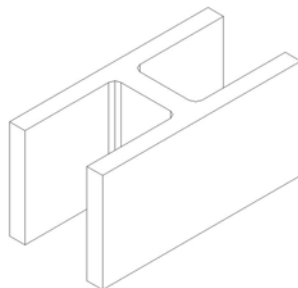

9030-1. General

- 1.1. Structural systems shall be selected on the basis of performance, life cycle costs, safety, maintenance, durability, constructability, availability of materials, coordination and accommodation of other building systems, and aesthetic considerations.
- 1.2. Expansion joints shall be provided in building elements as required to reduce the effects of thermal loads and isolate for seismic movement.
- 1.3. For structures that are anticipated to be renovated or expanded in the future, provide structural elements capable of resisting future loads. The drawings shall identify the location and loading assumptions of future expansions.

9030-2. Remote Site Considerations

- 2.1. Many BIA school sites are located far from facilities that provide construction materials or populations that provide certain labor skills. Consider the effects of lengthy transportation of products, such as delaying the set of ready-mixed concrete, and selecting precast concrete components that are optimized for transportation size and weight. Use simple, interchangeable rebar, formwork, and other products to reduce special trips from the material supplier. Specialized labor skills that may not be available include concrete post-tensioning, steel welding, and structural systems that require specialized extensive inspection for quality control.

9030-3. Corrosion

- 3.1. Consider the durability of structural elements subject to corrosion.
- 3.2. Refer to ACI 318 for concrete subject to corrosive salt and sulfate requirements. Do not place black rebar in exterior stair nosing.
- 3.3. Exterior carbon steel exposed to weather shall be protected with one of the following systems, as a minimum:
 - 3.3.1. Hot-dip galvanized per ASTM A123.
 - 3.3.2. Protected with an appropriate Society for Protective Coatings (SSPC) paint system and steel surfaces prepared using SSPC surface preparation SP-6 Commercial Blast Cleaning, or an equivalent or superior system.
- 3.4. If metal deck is used in exterior applications, the deck shall be specified with G90, minimum, coating and shall be 20 gauge or thicker.
- 3.5. Metal decking in interior applications in humid parts of the country shall be galvanized G60, minimum. Humid areas are defined as those that receive an average of 30 inches or more of precipitation annually, or those that are within 10 miles of an ocean. For average annual precipitation data, see <http://nationalatlas.gov/>
- 3.6. Steel lintels in exterior walls shall be hot-dip galvanized.

9030-4. Foundation Systems

4.1. General Structural Considerations

- 4.1.1. The Designer of Record shall review foundation systems recommendations as provided by the geotechnical engineer, in accordance with Section 4120, “Geotechnical Evaluation,” and shall recommend a foundation type, based upon an economical and performance-based comparison of the recommended systems. Consider and discuss local construction practices, risk, and cost in written recommendations to the BIA for their review and approval.
- 4.1.2. Many BIA school sites have expansive soils or poor soil-bearing pressure. The Designer of Record shall be sensitive to this issue and recognize that soil movement can often cause substantial building damage. The Designer of Record shall provide a foundation system to prevent damage. Past solutions to this problem include providing a deep foundation that will not move with soil movement, a mat foundation that can reduce the damaging effects of soil movement, or providing a flexible superstructure and finishes that can accommodate foundation movement. Brittle structures and finishes should be used only if they are compatible with the expected soil and foundation movement.
- 4.1.3. At sites where the geotechnical report indicates that expansive soils or settlement potential are present, consider whether the movement of a concrete slab on grade is within acceptable limits. If not, provide alternate solutions. Past solutions for this problem include modifying the soil properties below the slab, providing a structural floor capable of spanning to nonmoving supports, or a mat foundation that also serves as the floor. Also consider the effect of expansive soil or settlement potential on below-grade utility connections.
- 4.1.4. Where the geotechnical report indicates that slabs on grade are a recommended floor system, design and detail slabs on grade in accordance with ACI 302.1R and 360R. The use of underslab vapor barriers shall be considered and installed in accordance with ACI recommendations.
- 4.1.5. Design and detail slabs on grade, mat foundations, and crawl spaces for radon mitigation, where required, in conformance with NFPA 5000, Chapter 49.
- 4.1.6. The effect of groundwater on foundation systems shall be considered, both during construction and during the design life. Construction below the highest potential groundwater elevation shall be protected by a redundant dewatering system, or shall be made watertight and designed for the effects of hydrostatic loads and buoyancy.
- 4.1.7. In areas of deep fill, or at sites where the geotechnical report indicates collapsible soils, consider whether structures, including slabs on grade and site structures and sidewalks, will be damaged by settlement. If damaging

settlement is likely to occur, provide alternate solutions that prevent damaging movements. Also consider the effect of settlement on below-grade utility connections. Deep fill includes a depth of fill that exceeds 6 feet.

- 4.1.8. Foundation walls shall be constructed of reinforced masonry or concrete and designed in accordance with NFPA 5000. See Section 9020 for limitations on below-grade masonry construction.
- 4.1.9. Thresholds at exterior doors shall be detailed to provide support for site slabs such that the outward door swing is not impeded by frost heave or heave of expansive soils, and such that a tripping hazard due to a vertical offset between the interior and exterior slabs is prevented.
- 4.1.10. See Section 5030, "Site Design and Earthwork," for site retaining walls.

4.2. **Types of Foundation Systems.** The following systems have been successfully used on past projects. Other foundation systems may also be acceptable and shall be considered by the Designer of Record.

4.2.1. *Footings and Mats*

- 4.2.1.1. Concrete footings and mats shall be designed and installed in accordance with NFPA 5000, Chapter 36, Section 4, and in accordance with the geotechnical report.

4.2.2. *Drilled Piers, Caissons, and Auger Cast Piles*

- 4.2.2.1. Drilled piers and caissons shall not be longer than 30 times their diameter.
- 4.2.2.2. Drilled piers, caissons, and auger cast piles shall be designed and installed in accordance with NFPA 5000, Chapter 36, Section 5, and in accordance with the recommendations of the geotechnical report.

4.2.3. *Driven Piles*

- 4.2.3.1. Driven piles, constructed of steel, concrete-filled steel, precast concrete, or wood, shall be designed and installed in accordance with NFPA 5000, Chapter 36, Section 5, and in accordance with the geotechnical report.

THIS PAGE INTENTIONALLY LEFT BLANK

9040-1. General

- 1.1. Floor systems shall be coordinated with architectural, mechanical, plumbing, electrical, and other trades to provide sufficient space between floors for routing of utilities. Consider the structural depth of the floor system and routing of utilities through structural elements as necessary.
- 1.2. Floor systems shall achieve the fire rating as required by code.
- 1.3. Concrete slabs on metal deck shall have a minimum thickness of 3 inches. Concrete topping on precast floor members shall have a minimum thickness of 2 inches. Concrete may be normal weight or lightweight. Lightweight concrete density shall range from 90 pounds per cubic foot to 115 pounds per cubic foot.
- 1.4. Conduit may be run inside concrete slabs, in accordance with diameter and spacing limits as specified in ACI 318, Chapter 6, and as limited by Steel Deck Institute requirements.
- 1.5. Floor flatness shall be specified in accordance with ACI 302.1R.

9040-2. Performance Criteria**2.1. Vertical Deflection**

- 2.1.1. The maximum deflection for interior floor framing elements shall be in accordance with NFPA 5000.
- 2.1.2. The maximum deflection for spandrel beams and girders shall be in accordance with AISC Design Guide 3.

2.2. Vibration

- 2.2.1. Floor systems shall be designed to minimize vibration. For steel beam and/or steel joist framed floors, design for vibration shall be in accordance with AISC Design Guide 11. At classroom and administrative areas, design for walking excitation, according to AISC Design Guide 11 Chapter 4, with a maximum acceleration of 0.5 percent of gravity. For concrete floors, design for vibration shall be in accordance with ATC Design Guide 1.

2.3. Acoustics

- 2.3.1. Acoustical transmissions through floors due to occupants or equipment shall be minimized. Floors of mechanical penthouses shall be constructed with a minimum of 4 inches of normal-weight concrete.

9040-3. Preapproved Structural Systems

- 3.1. Preapproved structural systems are ranked into two categories. All other factors being equal, Tier 1 systems are preferred over Tier 2 systems, but both are acceptable.
- 3.2. **Schools.** The following are preapproved structural systems for above-grade floor construction in schools:

- 3.2.1. Concrete slab on composite metal deck on composite steel beams with headed shear studs welded through the floor deck to the beam flange. (Tier 1)
- 3.2.2. Concrete slab on metal floor deck on metal joists, supported by steel beams or masonry bearing walls or precast concrete bearing walls. Metal floor deck shall be form deck or composite deck. Metal joists may be composite or noncomposite. (Tier 1)
- 3.2.3. Concrete topping slab on precast double-tees or precast slabs on precast beams or precast bearing walls or masonry bearing walls. Concrete topping shall have a minimum thickness of 2 inches and shall be normal-weight concrete. Topping thickness may vary to level the floors. (Tier 2)
- 3.2.4. Cast-in-place concrete slab on cast-in-place columns or masonry or precast bearing walls. The cast-in-place slab may be flat slab, flat plate, or one-way joists, and shall be reinforced with mild steel. Post-tensioned concrete floor systems shall not be used. (Tier 2)
- 3.3. **Dormitories**. The following are preapproved structural systems for above-grade floor construction in dormitories:
 - 3.3.1. Concrete slab on composite metal deck on composite steel beams with headed shear studs welded through the floor deck to the beam flange. (Tier 1)
 - 3.3.2. Concrete slab on metal floor deck on metal joists supported by steel beams or masonry bearing walls or precast concrete bearing walls. Metal floor deck shall be form deck or composite deck. Metal joists may be composite or noncomposite. (Tier 1)
 - 3.3.3. Concrete topping slab on precast slabs (solid or hollow core) on precast beams or precast bearing walls or masonry bearing walls. Concrete topping shall have a minimum thickness of 2 inches and shall be normal-weight concrete. Topping thickness may vary to level the floors. (Tier 2)
 - 3.3.4. Cast-in-place concrete slab on cast-in-place columns or masonry bearing walls. The cast-in-place slab may be flat slab, flat plate, or one-way joists, and shall be reinforced with mild steel. Post-tensioned concrete floor systems shall not be used. (Tier 2)
 - 3.3.5. Lightweight concrete slab on metal floor deck on light-gauge steel “C” joists, supported by steel beams or bearing walls. Metal deck shall be 0.6 inches tall, minimum. Joists shall be spaced at 24 inches on center, maximum. Joist depths may range up to 12 inches deep. (Tier 2)
- 3.4. Other structural systems for floor construction are not permitted without prior written approval from the BIA.

9050-1. General Structural Considerations

- 1.1. Roof framing systems shall be coordinated with architectural, mechanical, plumbing, electrical, and other trades to provide sufficient space for routing of utilities and building services. Consider the structural depth of the roof system and routing of utilities through structural elements as necessary.
- 1.2. Roof systems shall achieve the fire rating as required by the building code.
- 1.3. Steep-slope and low-slope roofs are permitted. The use of steep-slope roofs in areas of substantial snow loading can help to reduce the snow retained on roof surfaces.
- 1.4. Roof overhangs shall be designed for wind uplift. Roof eaves shall be designed for ice dams and icicles along eaves. See ASCE 7.
- 1.5. Both internally drained roofs and externally drained roofs are permitted.
- 1.6. For large areas of metal roof deck that are exposed during construction, consider and accommodate length changes caused by temperature changes.

9050-2. Performance Criteria**2.1. Vertical Deflection**

- 2.1.1. The maximum deflection for interior floor framing elements shall be in accordance with NFPA 5000.
- 2.1.2. The maximum deflection for spandrel beams and girders shall be in accordance with AISC Design Guide 3.

2.2. Acoustics

- 2.2.1. Acoustical transmissions through roofs due to equipment shall be minimized.

9050-3. Preapproved Structural Systems

- 3.1. Preapproved structural systems are ranked into two categories. All other factors being equal, Tier 1 systems are preferred over Tier 2 systems, but both are acceptable.
- 3.2. **Schools.** The following roof framing systems are preapproved for roof construction in schools:
 - 3.2.1. Metal roof deck on metal joists supported by steel beams or masonry or precast concrete bearing walls. Roof deck shall be acoustic where required. (Tier 1)
 - 3.2.2. Structural wood sheathing (oriented-strand board or plywood) or metal deck on proprietary, factory-built, light-gauge steel trusses or light-gauge "C" roof joists pitched to achieve the sloped roof profile. (Tier 1)
 - 3.2.3. Precast double-tees or slabs on precast beams or precast or masonry bearing walls. (Tier 2)

- 3.3. Gymnasiums and Auditoriums.** The following roof framing systems are preapproved for roof construction in gymnasiums and auditoriums:
- 3.3.1.** Metal roof deck on long-span metal joists supported by masonry or precast concrete bearing walls. Acoustic roof deck shall be used unless an alternate acoustic treatment is specified by the architect. (Tier 1)
 - 3.3.2.** Precast double-tees on precast beams or precast or masonry bearing walls. (Tier 1)
 - 3.3.3.** Timber decking on glue-laminated timber beams. Decking shall be laminated, tongue-and-groove exposed timber decking, spanning to glue-laminated wood beams. Beams shall be supported on columns or load-bearing masonry or precast walls. (Tier 1)
 - 3.3.4.** Pre-engineered metal buildings are partially preapproved for the gymnasium structure. Because these systems are economical, the BIA acknowledges that using them may sometimes be necessary to meet the project budget. However, in such cases the Designer of Record must submit a written request for their use that outlines the steps taken to assure student safety (relative to projecting columns) and durability of the wall surfaces. The request shall also define the estimated cost savings. Metal building gym structures shall be independent of the surrounding structure to allow the metal building to deflect as designed. If it is not removed from the school, an expansion joint will be required. Metal buildings shall be designed and constructed in accordance with the MBMA *Metal Building Systems Manual*. The metal building manufacturer shall be certified under the American Institute of Steel Construction's Category MB Certification Program. (Tier 2)
- 3.4. Dormitories.** The following roof framing systems are preapproved for roof construction in dormitories:
- 3.4.1.** Metal roof deck on metal joists supported by steel beams or masonry or precast concrete bearing walls. Roof deck shall be acoustic where required. (Tier 1)
 - 3.4.2.** Structural wood sheathing (oriented-strand board or plywood) or metal deck on proprietary, factory-built, light-gauge steel trusses or light-gauge "C" roof joists pitched to achieve the sloped roof profile. (Tier 1)
 - 3.4.3.** Precast double-tees or slabs (hollow core or solid) on precast beams or precast or masonry bearing walls. (Tier 2)
- 3.5. Maintenance Buildings and Vehicle Storage Buildings.** The following roof framing systems are preapproved for roof construction in maintenance buildings and vehicle storage buildings:
- 3.5.1.** Pre-engineered metal building. Metal buildings shall be designed and constructed in accordance with the MBMA *Metal Building Systems Manual*. The metal building manufacturer shall be certified under the

American Institute of Steel Construction's Category MB Certification Program. (Tier 1)

- 3.5.2.** Metal roof deck on metal joists supported by steel beams or masonry bearing walls. (Tier 2)
- 3.5.3.** Structural wood sheathing (oriented-strand board or plywood) or metal deck on proprietary, factory built, light-gauge steel trusses pitched to achieve the sloped roof profile. (Tier 2)
- 3.6.** Other structural systems for roof construction are not permitted without prior written approval from the BIA.

THIS PAGE INTENTIONALLY LEFT BLANK

9060-1. General

- 1.1. Lateral load resisting systems shall be coordinated with architectural, mechanical, plumbing, electrical, and other trades to provide sufficient space for routing of utilities and building services.

9060-2. Performance Criteria**2.1. Strength**

- 2.1.1. Lateral load resisting systems shall be designed and detailed to resist wind loads, seismic effects, and unbalanced soil loads applied to the building structure.

2.2. Drift

- 2.2.1. The maximum allowable story drift resulting from wind loads shall be in accordance with AISC Design Guide 3.
- 2.2.2. The maximum allowable story drift resulting from seismic loads shall be as stated in ASCE 7.

9060-3. Preapproved Structural Systems

- 3.1. Preapproved structural systems are ranked into two categories. All other factors being equal, Tier 1 systems are preferred over Tier 2 systems, but both are acceptable.
- 3.2. **Schools.** The following are preapproved lateral load resisting systems in schools:
 - 3.2.1. Reinforced masonry shear walls. (Tier 1)
 - 3.2.2. Precast concrete shear walls. (Tier 1)
 - 3.2.3. Structural steel braced frames or moment frames. (Tier 1)
 - 3.2.4. Reinforced concrete shear walls. (Tier 1)
 - 3.2.5. Light-gauge steel stud shear walls with wood structural panels or sheet steel sheathing. See AISI Standard for Cold-Formed Steel Framing – Lateral Design for design of sheet steel shear walls. (Tier 2)
- 3.3. **Gymnasiums and Auditoriums.** The following are preapproved lateral load resisting systems in gymnasiums and auditoriums:
 - 3.3.1. Reinforced masonry shear walls. (Tier 1)
 - 3.3.2. Precast concrete shear walls. (Tier 1)
 - 3.3.3. Tension-only cross-bracing and moment frames in pre-engineered metal buildings (partially approved; see discussion in Section 9050, “Roof Framing Systems”). (Tier 2)
- 3.4. **Dormitories.** The following are preapproved lateral load resisting systems in dormitories:

- 3.4.1. Reinforced masonry shear walls. (Tier 1)
 - 3.4.2. Precast concrete shear walls. (Tier 1)
 - 3.4.3. Structural steel braced frames or moment frames. (Tier 1)
 - 3.4.4. Reinforced concrete shear walls. (Tier 1)
 - 3.4.5. Light-gauge steel stud shear walls with wood structural panels or sheet steel sheathing. See AISI Standard for Cold-Formed Steel Framing – Lateral Design for design of sheet steel shear walls. (Tier 2)
- 3.5. **Maintenance Buildings and Vehicle Storage Buildings.** The following are preapproved lateral load resisting systems in maintenance buildings and vehicle storage buildings:
- 3.5.1. Tension-only cross-bracing and moment frames in pre-engineered metal buildings. (Tier 1)
 - 3.5.2. Reinforced masonry shear walls. (Tier 1)
 - 3.5.3. Light-gauge steel stud shear walls with wood structural panels or sheet steel sheathing. See AISI Standard for Cold-Formed Steel Framing – Lateral Design for design of sheet steel shear walls. (Tier 2)
 - 3.5.4. Structural steel braced frames or moment frames. (Tier 2)
- 3.6. Other types of lateral load resisting systems are not permitted without prior written approval from the BIA.

9070-1. General**1.1. Columns**

- 1.1.1. Interior and exterior column locations and sizes shall be coordinated among all design disciplines.
- 1.1.2. Steel columns, cast-in-place concrete columns, precast concrete columns, or masonry columns are permitted for use.
- 1.1.3. Minimum forces for steel column anchorage to foundations shall be in accordance with OSHA 1926 – Subpart R.

1.2. Walls

- 1.2.1. Either bearing or nonbearing walls may be used. Bearing walls can be a more efficient use of material, because they serve multiple purposes, carrying gravity loads and lateral loads as well as serving as walls for architectural purposes. The use of bearing walls, however, may diminish flexibility for future modifications, because modifications affect gravity and lateral load carry capacities.

1.3. Stairs and Elevators

- 1.3.1. Structural framing around stair and elevator shafts may be used to carry gravity and lateral loads, either with bearing/shear walls or steel-braced frames.
- 1.3.2. Provide framing to support elevator guide rails.
- 1.3.3. If stairs are specified with a performance specification, clearly define how and where the stair can be supported from the building structure.

THIS PAGE INTENTIONALLY LEFT BLANK

9080-1. General

- 1.1. Structural wall systems shall be coordinated with architectural, mechanical, plumbing, electrical, and other disciplines.

9080-2. Performance Criteria**2.1. Deflection Out-of-Plane Due to Wind Loads**

- 2.1.1. The maximum deflection of metal stud walls shall conform to NFPA 5000, Table 35.1.2.8.1.1, except the deflection under the code-specified wind load for gypsum board and stucco walls shall be 1/360th of the length of the element.
- 2.1.2. The maximum deflection of metal stud walls supporting masonry or other brittle materials shall be 1/600th of the length of the element.

2.2. Acoustics

- 2.2.1. Acoustical transmissions through walls due to occupants or equipment shall be minimized. Refer to architectural sections for specific requirements.

9080-3. Preapproved Exterior Wall Systems

- 3.1. Preapproved structural exterior wall systems are ranked into two categories. All other factors being equal, Tier 1 systems are preferred over Tier 2 systems, but both are acceptable.
- 3.2. **Classrooms and Administrative Areas.** The following are preapproved exterior wall systems in school classrooms and administrative areas:
 - 3.2.1. Non-load-bearing metal stud walls composed of galvanized metal “C” studs with pre-punched webs. Studs are attached to the frame with proprietary slip clips. Studs shall be spaced at 16 inches on center, maximum. Metal stud galvanizing shall be G60, minimum, in arid climates and G90, minimum, in humid climates. Slip clips shall not allow more than 1/8 inch out-of-plane deflection under lateral wind loads. (Tier 1)
 - 3.2.2. Load-bearing masonry walls composed of lightweight or normal-weight concrete masonry or clay masonry, partially or fully grouted and reinforced with steel rebar. Thickness may range from 6 inches up to 12 inches. Walls may have pilasters as required to support heavy point loads. (Tier 1)
 - 3.2.3. Load-bearing precast concrete wall panels composed of insulated sandwich panels or noninsulated panels made from normal-weight or lightweight concrete. Thickness ranges from 6 inches to greater than 12 inches. Sandwich panels have a face of concrete, rigid insulation, and a backing of concrete. Panels may be site cast or plant cast. (Tier 2)

- 3.2.4.** Load-bearing metal stud walls composed of galvanized metal “C” studs with pre-punched webs. Studs are centered under roof trusses or “C” joist rafters for load-bearing applications. Studs shall be spaced at 16 inches on center, maximum. Metal stud galvanizing shall be G60, minimum, in arid climates and G90, minimum, in humid climates. Load-bearing metal stud walls shall not be used to support classroom floors. (Tier 2)
- 3.3. Gymnasiums and Auditoriums.** The following are preapproved exterior wall systems in gymnasiums and auditoriums:
- 3.3.1.** Load-bearing masonry walls composed of lightweight or normal-weight concrete masonry or clay masonry, partially or fully grouted and reinforced with steel rebar. Thickness may range from 6 inches up to 12 inches. Walls may have pilasters as required to support heavy point loads. Pilasters shall be positioned to avoid interior wall projections that could be a safety hazard to students. (Tier 1)
- 3.3.2.** Load-bearing precast wall panels composed of insulated sandwich panels or noninsulated panels with normal-weight or lightweight concrete. Thickness ranges from 6 inches to greater than 12 inches. Sandwich panels have a face of concrete, rigid insulation, and a backing of concrete. Panels may be site cast or plant cast. (Tier 1)
- 3.3.3.** Metal wall panels at metal building (see Section 9050, “Roof Framing Systems,” for discussion). (Tier 2)
- 3.4. Dormitories.** The following are preapproved exterior wall systems in dormitories:
- 3.4.1.** Load-bearing masonry walls composed of lightweight or normal-weight concrete masonry or clay masonry, partially or fully grouted and reinforced with steel rebar. Thickness may range from 6 inches up to 12 inches. Walls may have pilasters as required to support heavy point loads. (Tier 1)
- 3.4.2.** Load-bearing precast wall panels composed of insulated sandwich panels or noninsulated panels of normal-weight or lightweight concrete. Thickness ranges from 6 inches to greater than 12 inches. Sandwich panels have a face of concrete, rigid insulation, and a backing of concrete. Panels may be site cast or plant cast. (Tier 2)
- 3.4.3.** Load-bearing or non-load-bearing metal stud walls composed of galvanized metal “C” studs with pre-punched webs. Studs are attached to the frame with proprietary slip clips for non-load-bearing walls and are centered under joists for load-bearing applications. Studs shall be spaced at 16 inches on center, maximum. Metal stud galvanizing shall be G60, minimum, in arid climates and G90, minimum, in humid climates. Slip clips shall not allow more than 1/8 inch out-of-plane deflection under lateral wind loads. (Tier 2)

- 3.5. Maintenance Buildings and Vehicle Storage Buildings.** The following are preapproved exterior wall systems in maintenance buildings and vehicle storage buildings:
- 3.5.1.** Metal panel walls at metal buildings. (Tier 1)
 - 3.5.2.** Load-bearing or non-load-bearing metal stud walls composed of galvanized metal “C” studs with pre-punched webs. Studs are attached to the frame with proprietary slip clips for non-load-bearing walls and are centered under joists for load-bearing applications. Studs shall be spaced at 16 inches on center, maximum. Metal stud galvanizing shall be G60, minimum, in arid climates and G90, minimum, in humid climates. Slip clips shall not allow more than 1/8 inch out-of-plane deflection under lateral wind loads. (Tier 2)
 - 3.5.3.** Load-bearing masonry walls composed of lightweight or normal-weight concrete masonry or clay masonry, partially or fully grouted and reinforced with steel rebar. Thickness may range from 6 inches up to 12 inches. Walls may have pilasters as required to support heavy point loads. (Tier 2)
- 3.6.** Other types of exterior wall systems are not permitted without prior approval from the BIA.

9080-4. Preapproved Interior Structural Wall Systems

- 4.1.** Preapproved interior wall structural systems are ranked into two categories. All other factors being equal, Tier 1 systems are preferred over Tier 2 systems, but both are acceptable.
- 4.2. Classrooms and Administrative Areas.** The following are preapproved interior structural wall systems in school classrooms and administrative areas:
- 4.2.1.** Load-bearing masonry walls composed of lightweight or normal-weight concrete masonry or clay masonry, partially or fully grouted and reinforced with steel rebar. Thickness may range from 6 inches to 12 inches. Walls may have pilasters as required to support heavy point loads. (Tier 1)
 - 4.2.2.** Load-bearing precast wall panels composed of reinforced normal-weight or lightweight concrete. Thickness may range from 6 inches to 12 inches. Wall panels may be site cast or plant cast. (Tier 1)
 - 4.2.3.** For support of roof structural only, load-bearing metal stud walls composed of galvanized metal “C” studs with pre-punched webs. Studs are centered under joists for load-bearing applications. Studs shall be spaced at 16 inches on center, maximum. Metal stud galvanizing shall be G60, minimum, in arid climates and G90, minimum, in humid climates. (Tier 2)

- 4.3. Gymnasiums and Auditoriums.** The following are preapproved interior structural wall systems in gymnasiums and auditoriums:
- 4.3.1.** Load-bearing masonry walls composed of lightweight or normal-weight concrete masonry or clay masonry, partially or fully grouted and reinforced with steel rebar. Thickness may range from 6 inches to 12 inches. Walls may have pilasters as required to support heavy point loads. Pilasters shall be positioned to avoid interior wall projections that could be a safety hazard to students. (Tier 1)
 - 4.3.2.** Load-bearing precast wall panels composed of reinforced normal-weight or lightweight concrete. Thickness may range from 6 inches to 12 inches. Wall panels may be site cast or plant cast. (Tier 1)
- 4.4. Dormitories.** The following are preapproved interior structural wall systems in dormitories:
- 4.4.1.** Load-bearing masonry walls composed of lightweight or normal-weight concrete masonry or clay masonry, partially or fully grouted and reinforced with steel rebar. Thickness may range from 6 inches to 12 inches. Walls may have pilasters as required to support heavy point loads. (Tier 1)
 - 4.4.2.** Load-bearing precast wall panels composed of reinforced normal-weight or lightweight concrete. Thickness may range from 6 inches to 12 inches. Wall panels may be site cast or plant cast. (Tier 1)
 - 4.4.3.** Load-bearing metal stud walls composed of galvanized metal “C” studs with pre-punched webs. Studs are centered under joists. Studs shall be spaced at 16 inches on center, maximum. Metal stud galvanizing shall be G60, minimum, in arid climates and G90, minimum, in humid climates. (Tier 1)
- 4.5.** Other types of interior structural wall systems are not permitted without prior approval from the BIA.

9090-1. General

1.1. Appurtenances to building structures include, but are not limited to:

- Canopies
- Sunscreens
- Covered walkways
- Ground-supported screen walls

1.2. Consider the following:

- 1.2.1. Snow loads may be significantly increased due to drifting from higher roofs onto lower surfaces.
- 1.2.2. Appurtenances are often open and are subjected to special wind load effects.
- 1.2.3. Appurtenances are often exposed to weather. Provide protection from corrosion. See Section 9030 for more information.
- 1.2.4. Appurtenances are often composed of multiple materials, including steel, stainless steel, galvanized steel, and aluminum. Consider the effects of galvanic corrosion due to dissimilar metals.

THIS PAGE INTENTIONALLY LEFT BLANK

10000-1. Introduction

- 1.1. This chapter shall be used as a guideline in the development of the HVAC, plumbing, and temperature controls/energy management design documents for all new BIA school facilities. The design shall be in conformance with these guidelines unless exceptions to them are granted by the BIA.
- 1.2. Refer to Chapter 1, “General Information,” and Chapter 2, “Presentation of Data,” for required documents, drawing and specifications formats, and other design and submittal requirements not discussed in this chapter.
- 1.3. Additional design and submittal requirements may apply for projects with unusual or highly technical criteria.
- 1.4. As applicable, the Designer of Record shall incorporate the sustainability strategies identified in Chapter 3, “LEED Goals and Guidelines.”
- 1.5. The guidelines in this chapter should be used in conjunction with those in the other chapters in this handbook, and the Designer of Record should coordinate with the other project consultants to be sure all aspects of the school facility are effective and compatible.
- 1.6. All design features must be weighed carefully for their initial cost, long-term maintenance cost and needs, durability, and their impact on the environment.

10000-2. Design Team Goals

- 2.1. The design team shall accomplish the following:
 - Design all school facilities and dormitories to meet LEED Silver certification requirements. (Refer to Chapter 3.)
 - Meet energy and environmental performance criteria.
 - Optimize design choices through simulations, models, and other design tools.
 - Employ life-cycle cost analysis (LCCA) in all decision making.
 - Design all systems for ease of maintenance and operation.
 - Provide clear guidance, documentation, and training for operation and maintenance staff.

10000-3. Documents

- 3.1. Specific design submittal requirements in this chapter supplement the requirements in Chapter 2. All documents, including drawings, specifications, calculations, and analyses shall be submitted in phases in accordance with Chapter 2.

3.2. Specifications

- 3.2.1. Describe each system and all equipment to the greatest extent possible. Equipment shall be selected from among three manufacturers who meet specified requirements.

3.3. Drawings

- 3.3.1. Provide complete plans, elevations, and sections at a minimum scale of 1/8 inch equals 1 foot for all HVAC and plumbing systems. HVAC and plumbing shall not be combined on the same drawings.
- 3.3.2. Do not superimpose mechanical equipment, ductwork, and piping on architectural plans.
- 3.3.3. Provide plan(s) and elevations(s) of all mechanical equipment rooms that are used for primary equipment such as boilers, chillers, and air handlers. A scale of not less than 3/8 inch equals 1 foot shall be used.
- 3.3.4. Provide details as needed to illustrate or to clarify equipment installation. Details shall include piping diagrams for pumps, coils, chillers, and boilers.
- 3.3.5. Provide complete and separate legends for plumbing and for HVAC systems.
- 3.3.6. Control drawings shall be consolidated on one or more sheets. The drawings shall include control diagrams and the location of all sensors, controlled devices, and direct digital controllers.
- 3.3.7. Equipment schedules shall, as a minimum, include all equipment listed in this mechanical guide. All capacities, power requirements (horsepower, phase, voltage, frequency, speeds), sizes, and special requirements shall be shown. Schedules shall be consolidated on one or more sheets.
- 3.3.8. Schematic flow diagrams shall be provided for each HVAC and piping system. Flow diagrams shall indicate flows, temperatures, and pressures, as appropriate. The diagrams shall indicate all devices, including valves (balancing and shutoff), strainers, check valves, temperature/flow indicators, control valves, drain valves, expansion tanks, etc. These diagrams may be combined with control drawings.
- 3.3.9. Plumbing plans shall also include roof drainage systems and waste, vent, and water piping, including fixtures, cleanouts, wall hydrants, isolation valves, and service entrance location. The minimum scale shall be 1/8 inch equals 1 foot.
- 3.3.10. For kitchens, toilet areas, and shower areas, plans and sections shall use a minimum scale of 1/4 inch equals 1 foot.
- 3.3.11. Provide isometric diagrams for waste/vent and water piping systems as required by the Uniform Plumbing Code (UPC) and local authorities.

3.4. Energy Budget Analysis

- 3.4.1.** The energy budget shall be established early in the design process. It shall be determined through preliminary building energy modeling, which begins in the schematic design process.
- 3.4.2.** Refer to Section 10010 for minimum requirements.

3.5. Design Analysis

- 3.5.1.** Refer to Section 10010, “Mechanical Systems Selection Criteria,” for energy simulation evaluations, evaluation tools, and energy goals/concepts.
- 3.5.2.** Justification for system and equipment selections shall be based on energy consumption reduction from an established baseline, in accordance with ASHRAE 90.1; from an LCCA on selected items; and from an evaluation of critical issues such as system flexibility, simplicity, and ease of maintenance/operation. To evaluate such items, a matrix comparing life-cycle costs with other selected criteria shall be developed. A narrative that discusses evaluated options, conclusions, and recommendations along with supportive calculations shall also be submitted.
- 3.5.3.** Systems/equipment requiring a design analysis shall include:
- Building envelope/orientation optimization
 - Daylighting and lighting system optimization
 - HVAC system selection optimization
 - Optimization of system design parameters that affect operating efficiencies, such as part load efficiencies
 - Selection of optimum fuels
- 3.5.4.** Also perform a design analysis when considering the following options:
- Dedicated outside air systems with heat recovery
 - Cooling towers compared to air-cooled condensers
 - Variable speed pumping
 - Solar domestic hot water systems
 - Other systems identified in this chapter requiring a design analysis

3.6. Required Design Calculations

- 3.6.1.** Heating/cooling loads.
- 3.6.2.** Design pressure drop and velocities for ductwork, hydronic piping, and gas piping.
- 3.6.3.** Building utilities pipe sizing.
- 3.6.4.** Plumbing fixture counts.

- 3.6.5.** Piping stress calculations for hot water systems (operating temperatures over 150°F).
- 3.6.6.** Seismic calculations as required.
- 3.6.7.** Water treatment tests and evaluations.
- 3.6.8.** Acoustical evaluations and recommendations for rotating equipment and distribution systems.
- 3.6.9.** Other calculations required in this guide and by identified codes.

10000-4. Quality Control

- 4.1.** Quality control review shall include, but not be limited to, the following:
 - 4.1.1.** Perform a complete, independent review for errors, omissions, and coordination within and between disciplines.
 - 4.1.2.** Verify that equipment locations are indicated.
 - 4.1.3.** Verify that all equipment that is indicated on schedules, one-line diagrams, and specifications is indicated on the plans.
 - 4.1.4.** Verify that all equipment is properly identified.
 - 4.1.5.** Verify that ducts or piping are not routed over electrical equipment.
 - 4.1.6.** Verify that power is supplied to all equipment.
 - 4.1.7.** Coordinate data and requirements with the electrical design.
 - 4.1.8.** Verify that all motors and power-consuming equipment are shown on the plans and schedules.
 - 4.1.9.** Verify that the legend matches the symbols used on the plans.
 - 4.1.10.** Verify that the design meets the scope of work and complies with the design guideline requirements.
 - 4.1.11.** Verify that building utilities are coordinated with outside utilities.

10000-5. Building Types

- 5.1.** Designs shall be modified as appropriate for code compliance and best practices for the building type. Possible building types and special areas include:
 - Elementary schools
 - Middle schools
 - High schools
 - Dormitories
 - Bus garages
 - Maintenance facilities
 - Kitchens
 - Gymnasiums

10000-6. Local Parts Availability

- 6.1.** Verify that local availability of spare parts, replacement parts, and service technicians for equipment is specified.
- 6.2.** If equipment is not locally available, determine the response time for obtaining it and verify with the BIA that the time is acceptable.

10000-7. Warranty

- 7.1.** Additional or extended warranties are noted in other sections of this chapter. As a minimum, warranties for refrigerant compressors and domestic hot water heaters shall be 5 years and shall include parts, labor, and refrigerant.

THIS PAGE INTENTIONALLY LEFT BLANK

10010-1. Systems Evaluation

- 1.1. This section presents guidelines for mechanical ventilation, heating, and cooling systems, along with the goals the BIA has established for their schools and dormitories.
- 1.2. **Energy Simulation Evaluation.** The following standards and programs are acceptable for use in generating a detailed evaluation of proposed heating, ventilating, and air-conditioning systems.
 - 1.2.1. ***ASHRAE 90.1.*** This standard evaluates building envelopes, building orientation, and mechanical and electrical systems.
 - 1.2.2. ***Building Loads Analysis and System Thermodynamics (BLAST).*** This program has been developed by the United States Department of Defense and is available through the University of Illinois, www.bso.uiuc.edu.
 - 1.2.3. ***Carrier's Hourly Analysis Program (HAP).*** This is a software system network. Use of this program to generate the building load data will be considered, but must be submitted for approval prior to use.
 - 1.2.4. ***DOE-2.*** This program analyzes the energy efficiency of buildings using an hourly weather file and simulating energy performance during a typical year. Contact Lawrence Berkeley National Laboratory, www.lbl.gov. Visual DOE, Power DOE, and eQuest are available user graphic interfaces for DOE-2.
 - 1.2.5. ***Energy Plus.*** This program is being developed by the U.S. Department of Energy and is a successor to both DOE-2 and BLAST. Contact Lawrence Berkeley National Laboratory, www.lbl.gov.
 - 1.2.6. ***Trane Trace 700.*** This program has been developed by the Trane Company and is available through their Customer Direct Service (CDS).
- 1.3. **Energy Goals and Concepts**
 - 1.3.1. All schools and dormitories shall be designed to obtain a LEED Silver certification.
 - 1.3.2. The ASHRAE 90.1 energy standards and requirements **shall be exceeded by at least 30 percent or shall be less than 50,000 Btu's per square foot per year**, whichever is less.
 - 1.3.3. Items identified for life-cycle cost analysis (LCCA) shall be evaluated in accordance with the Code of Federal Regulations Title 10: Energy.

- 1.3.4. Use the latest version of the *National Best Practices Manual for Building High Performance Schools* as a reference for design strategies. The following are high-performance building concepts that shall be included in each design:
- Individual temperature controls for classrooms and significant spaces.
 - Continuous measurement of all energy sources.
 - Direct digital control (DDC) and energy management systems. Use local area networks and the Internet for remote control and monitoring.
 - Occupancy sensors to control HVAC and lighting systems.
 - Carbon dioxide sensors to control ventilation air quantities.
 - Premium-efficiency motors.
- 1.3.5. The following should be considered in each design through an LCCA evaluation:
- Dedicated outside air systems with heat recovery.
 - Domestic hot water (DHW) solar preheaters.
 - Variable-frequency drives on pumps and fans that are 10 horsepower and larger when systems need variable quantities.
 - Renewable energy sources such as photovoltaic, wind, and geothermal exchange. Consider including these technologies as classroom demonstration projects.

10020-1. General

- 1.1. The mechanical design for schools and dormitories shall comply with all applicable current codes, standards, and laws. For a more general list of codes and standards that apply to BIA educational facilities, refer to Chapter 1, “General Information.” During design, report any required deviations from codes and standards to the Contracting Officer.
- 1.2. Where two codes, standards, or laws are applicable to the topic under review, use the more conservative or more stringent. Consult with the BIA Office of Facilities Management and Construction (OFMC) to resolve any questions or conflicts regarding application of codes and standards.

10020-2. Applicable Codes and Standards

- 2.1. The design criteria shall comply with the guidelines published by or contained in the following:

2.1.1. *Air-Conditioning and Refrigeration Institute (ARI)*

- Standard 210-240 – Performance Rating of Unitary Air-Conditioning & Air-Source Heat Pump Equipment
- Standard 310/380 – Standard for Packaged Terminal Air-Conditioners and Heat Pumps (CSA-C744-04)
- Standard 320 – Water-Source Heat Pumps
- Standard 410 – Forced-Circulation Air-Cooling and Air-Heating Coils

2.1.2. *American National Standards Institute (ANSI)*

- B31.1 Power Piping
- S12.60 Acoustical Performance Criteria, Design Requirements, and Guidelines for Schools

2.1.3. *American Society of Heating, Refrigerating, and Air-Conditioning Engineers (ASHRAE)*

- Latest edition of the following handbooks: *Fundamentals*, *HVAC Applications*, *HVAC Systems and Equipment*, and *Refrigeration*
- Standard 15 Safety Standard for Refrigeration Systems
- Standard 55 Thermal Environmental Conditions for Human Occupancy
- Standard 62.1 Ventilation for Acceptable Indoor Air Quality
- Standard 90.1 Energy Standard for Buildings Except Low-Rise Residential Buildings
- Standard 90.2 Energy Efficient Design of Low-Rise Residential Buildings

- Standard 100 Energy Conservation in Existing Buildings
 - Standard 135 BACnet – A Data Communication Protocol for Building Automation and Control Networks
- 2.1.4. *American Society of Mechanical Engineers (ASME)***
- CSD-1 – Controls and Safety Devices for Automatically Fired Boilers
 - Section IV – Rules for Construction of Heating Boilers
 - Section VIII – Rules for Construction of Pressure Vessels Division 1
- 2.1.5. *Code of Federal Regulations (CFR)***
- Title 10, Chapter II, Part 435 Energy Conservation Voluntary Performance Standards for New Buildings
 - Title 10, Chapter II, Part 436 Federal Energy Management and Planning Programs
- 2.1.6. *International Association of Plumbing and Mechanical Officials (IAPMO)***
- Uniform Mechanical Code (UMC)
 - Uniform Plumbing Code (UPC)
- 2.1.7. *National Fire Protection Association (NFPA)***
- NFPA 5000 Building Construction and Safety Code
 - NFPA 90A Standard for the Installation of Air-Conditioning and Ventilating Systems
 - NFPA 101 Life Safety Code
- 2.1.8. *National Institute of Standards and Technology (NIST)***
- Handbook 135 *Life-Cycle Costing Manual for the Federal Energy Management Program*
 - Public Law 109-58 Energy Policy Act of 2005
- 2.1.9. *Sheet Metal and Air Conditioning Contractors' National Association (SMACNA)***
- Latest edition *HVAC Duct Construction Standards – Metal and Flexible*
 - Latest edition *HVAC Systems – Testing, Adjusting & Balancing*
- 2.1.10. *United States Access Board***
- Americans with Disabilities Act and Architectural Barriers Act Accessibility Guidelines (ADAABAAG)

2.1.11. U.S. Green Building Council – Leadership in Energy Performance and Environment Design (LEED)

- *LEED Reference Guide for New Construction & Major Renovations*
- *LEED-NC Green Building Rating System for New Construction & Major Renovations*

THIS PAGE INTENTIONALLY LEFT BLANK

10030-1. General

- 1.1. Use the ASHRAE heating, ventilation, and air-conditioning (HVAC) handbooks to develop the HVAC design.

10030-2. Outdoor Air Design Values

- 2.1. Summer and winter outside air design values shall be derived from standard ASHRAE-compiled weather data located in the latest edition of the *ASHRAE Handbook – Fundamentals*. Use the 2½ percent design values for heating design dry-bulb, the 97½ percent design values for cooling design dry-bulb, and the mean coincidental wet-bulb temperatures.

10030-3. Indoor Air Design Values

- 3.1. The occupied temperatures used for building load calculations shall be within the range denoted for summer and winter values. Summer design values shall range from 75°F to 78°F. Winter design values shall range from 70°F to 72°F. The relative humidity of the building spaces shall be targeted at 50 percent or less. Humidification shall not be added to spaces unless specifically required by specialized equipment.
- 3.2. Night setback temperatures shall be used for all systems. Winter setback temperatures shall be 60°F.

10030-4. Outdoor Air Ventilation Requirements

- 4.1. Outdoor ventilation rates shall be calculated for each occupied space and shall conform to the requirements of ASHRAE 62.1.
- 4.2. Each system shall be evaluated for the use of a 100 percent air economizer cycle to cool the building when outside air conditions are conducive to cooling. ASHRAE 62.1 shall be used to determine whether enthalpy or sensible controlled economizers shall be used.
- 4.3. Energy recovery systems shall be considered in the ventilation design for heat pump systems, classrooms, gymnasiums, locker rooms, and student dining/cafeteria systems for reducing energy consumption.
- 4.4. Demand-controlled ventilation (DCV) systems shall be used to control the quantity of outside air. Carbon dioxide sensors shall be located in the most densely occupied spaces where an air handling system is supplying air. Levels shall be monitored through the direct digital control (DDC) system to verify that the system is maintaining a carbon dioxide level in the occupied rooms relative to the outdoors of no more than 400 plus or minus 50 parts per million (ppm).

10030-5. Designing Systems at Elevations Above Sea Level

- 5.1. Equipment and distribution systems are typically rated at sea level conditions. At elevations above sea level, equipment and systems shall be sized to compensate for changes in air density.

10030-6. Selection of HVAC Systems

6.1. In selecting the HVAC systems, evaluate the environmental criteria of the facility. Combinations of systems and central equipment shall be considered. A computerized energy analysis of at least three systems will be required for each facility at the schematic design stage, unless this requirements is specifically excluded by the BIA.

6.2. Equipment Selection

6.2.1. To ensure that the design performs well, it is important to integrate the HVAC systems with the building envelope/orientation and daylighting/lighting systems. The design strategies shall be appropriate for the different climatic zones of the project.

6.2.2. When selecting systems and equipment, take into account part-load operation and part-load efficiency. The choice of the optimal system type for a specific school shall be based on the following factors:

- Life-cycle cost (includes first cost, maintenance cost, and operations cost)
- Maintainability
- Simplicity of operation
- Durability
- Reliability
- Acceptable sound levels
- Space requirements
- Water conservation
- Classroom environmental control
- Indoor air quality
- Cooling/heating effectiveness

6.2.3. School HVAC systems to be considered for life-cycle cost analysis (LCCA) justification are:

- Packaged air handling units with chilled water cooling and with variable air volume (VAV) terminal reheat hot water heating
- Same system as above, except with integral direct expansion (DX) refrigeration/air condensate system
- Ground source heat pump systems

6.2.4. Dormitories shall be designed with a four-pipe heating/cooling fan coil system with reverse-return piping. The preferred zoning shall be two rooms per fan coil unit. The maximum number of rooms per fan coil unit shall be four, subject to BIA approval. For bathrooms, consider central

makeup air systems combined with a central exhaust system that utilizes a heat recovery system. A two-pipe system for heating/cooling shall not be used.

- 6.2.5. Alternative HVAC systems that are not listed above shall be permitted, provided they prove beneficial relative to energy analysis, life-cycle cost analysis, and maintainability. Alternative systems shall be evaluated against the preapproved systems described in this handbook.
- 6.2.6. Unit ventilator and fan coil units for primary cooling/heating shall not be used in schools.
- 6.2.7. Evaporative cooling systems for kitchen makeup air are the preferred systems. Verify that the climatic area is conducive to evaporative cooling.
- 6.2.8. Gymnasium designs shall use one air handling unit, demand ventilation utilizing carbon dioxide sensor control, and shall consider the use of a sock duct distribution system.
- 6.2.9. Large assembly spaces shall be designed with dedicated air handling units to accommodate high ventilation loads. A carbon dioxide monitor/control system shall be used.
- 6.2.10. Administrative areas shall be designed to operate independently of other areas year round.

6.3. Year-Round Cooling Requirements

- 6.3.1. If an air-conditioning system serves areas that have high internal heat gains, such as electronic equipment areas (e.g., telecommunications rooms), consider possible year-round cooling requirements and design the system accordingly. This will include provisions for low ambient operation of air-cooled condensers. Provide for reheating of supply air where justified. For environmental considerations pertaining to telecommunications rooms, refer to Section 13030.

10030-7. Air Systems

7.1. Air Handling Units

- 7.1.1. Locate air handling units (AHUs) strategically throughout the building for good air distribution and to facilitate partial building operation. Desirable locations are inside the building near the building's center and at an outside, accessible wall location. AHUs shall be located in mechanical rooms, mezzanines, or in rooftop penthouses. Non-enclosed rooftop units are not permitted.
- 7.1.2. As a minimum, each AHU shall include the following components: a supply/return air fan, cooling coil, preheating coil, Minimum Efficiency Reporting Value (MERV) 13 filters (use two stages of filtration), a mixing box, DDC stand-alone controls, an access section, an economizer, and a

variable frequency drive (VFD). The maximum capacity for each system shall be limited to 30,000 cubic feet per minute.

- 7.1.3. The AHU shall be designed to deliver a minimum of 55°F supply air to the terminal units. For morning warm-up, heating coils shall be sized to deliver a minimum of 100°F supply air to the terminal units.
- 7.1.4. To vary the air volume available to the system, each variable air volume AHU shall use a VFD fan motor.
- 7.1.5. Energy recovery methods shall be evaluated to temper the outside air.
- 7.1.6. VAV systems shall be used for classrooms, media centers, gymnasiums, student dining, cafetorium and food service, music, and administration areas.
- 7.1.7. Air handler system zoning shall conform to LEED-NC Indoor Environmental Quality credit requirements for controllability of systems and thermal comfort. Zoning plans shall be developed and shall be submitted with the Design Development package. General administrative areas (up to 500 square feet), individual offices/support rooms (more than 300 square feet), each classroom/related support room, each conference room, gymnasiums, and dining halls shall be single zones.
- 7.1.8. Packaged AHUs with integral DX refrigeration systems shall use scroll compressors. Multiple compressors shall be used to allow operation down to 25 percent of design without using hot gas bypass.

7.2. Ductwork Distribution Systems

- 7.2.1. Ductwork shall be designed in accordance with applicable SMACNA standards and ASHRAE recommendations. Internally lined ductwork is not allowed. All supply and return air (in unconditioned space) shall be insulated in accordance with ARCOM MASTERSPEC 23 07 00 HVAC Insulation.
- 7.2.2. *Variable Air Volume Reheat Terminal Units*
 - 7.2.2.1. Terminal units shall be located above the ceiling and shall control the flow of air to the space based on a space temperature sensor. Terminal units should be located in an accessible location above the ceiling (where ceilings exist) to allow for maintenance.
 - 7.2.2.2. On a rise in space temperature, the damper in the terminal unit will open and allow air from the duct system into the space. As the space temperature falls, the damper will close to a minimum predetermined position before heating (ASHRAE 90.1). The minimum position shall be set to maintain the required ventilation rate in the space. On a continued fall in space temperature, the heating coil control valve at the terminal unit shall be opened to maintain the space set point.

- 7.2.2.3.** If the terminal unit described above when in compliance with ASHRAE 90.1 fails to achieve the necessary space heating, a parallel fan-powered box system shall be used in conjunction with the variable air volume terminal. The fan-powered box shall return ceiling plenum air through a heating coil to the space.

7.2.3. *Low-Pressure Supply Air Ductwork*

- 7.2.3.1.** Air will be distributed to terminal air devices located throughout the space via a low-pressure ductwork system. The maximum air velocity in this part of the ductwork system shall be less than 1,200 feet per minute.
- 7.2.3.2.** Supply-air ductwork connections to ceiling-mounted air devices may be completed with flexible ductwork. Duct lengths shall not exceed 10 feet.
- 7.2.3.3.** Air devices shall be ceiling mounted wherever possible. If spaces do not include ceilings, the air devices should be wall or duct mounted and shall be out of the reach of students.
- 7.2.3.4.** Each low-pressure duct leading to an air device shall include a manual volume damper to balance the system. Dampers on air devices shall not be used for balancing.

7.2.4. *Return/Relief Air Systems*

- 7.2.4.1.** Return air may be ducted to the AHUs or transferred by return air plenums as allowed by codes.
- 7.2.4.2.** All AHUs shall have a return/relief air fan for maintaining positive building pressurization.
- 7.2.4.3.** The return/relief air fan shall be variable volume and sized to maintain under all operating conditions a slight positive pressure in the general spaces. Building pressure shall be maintained by controlling the return air fan discharge pressure at a constant setting, and by then controlling the relief/exhaust damper to maintain a set building pressure with respect to the outdoors.

7.2.5. *Electric Resistance Heating*

- 7.2.5.1.** Electric resistance heating for comfort applications is not allowed, except for unusual situations and where approval is obtained from the BIA. Supplemental resistance electric heaters can be used with water source heat pump systems.

- 7.2.6.** Ductwork shall not pass through a telecommunications room or an electrical room.

7.3. Exhaust Air Systems

- 7.3.1. General exhaust systems shall be provided to exhaust restrooms, electrical rooms, mechanical rooms, custodial closets, and storage rooms. Exhaust discharge shall be located downwind of air handler intakes and operable windows.
- 7.3.2. Roof-mounted fans are not recommended but may be used on low-profile roofs.
- 7.3.3. Interior fans shall be used for general building exhaust. Fans shall not be located over sound-sensitive areas such as classrooms, media centers, and conference rooms. Fans shall be installed within 2 feet of an accessible ceiling (where ceilings exist) to allow for maintenance.

7.3.4. *Special Exhaust Systems*

- 7.3.4.1. Science and art rooms shall have general exhaust systems in addition to a supply/return air system to remove odors associated with experiments, paint, and chemicals. These exhaust systems shall be manually controlled using 2-hour timer switches within the space. A slight negative pressure in the room with respect to the surrounding area shall be maintained. Makeup air systems interlocked with the general exhaust may be necessary to maintain a slight negative pressure.
- 7.3.4.2. Kitchen canopy systems shall be provided over kitchen cooking equipment where required by applicable codes. Kitchen canopies shall include exhaust and makeup air as required by applicable codes. The kitchen ventilation and exhaust system shall be designed in accordance with the latest edition of the *ASHRAE Handbook – HVAC Applications* and shall comply with NFPA 96 Standard for Ventilation Control and Fire Protection of Commercial Cooking Operations.
- 7.3.4.3. Dishwasher exhaust shall be designed to meet the requirements set forth by the dishwasher manufacturer. Direct-connected system or overhead exhaust hood arrangements shall be used as appropriate.

7.3.5. *Locker Room Exhaust Systems and Equipment Rooms Ventilation*

- 7.3.5.1. Locker room spaces shall be exhausted independently from the building general exhaust systems. The quantity of exhaust shall be designed to meet the minimum code requirements, but shall not be less than 1.5 cubic feet per minute per square foot of floor area.
- 7.3.5.2. The exhaust shall be grouped from specific spaces, such as men's locker rooms or women's locker rooms. Energy recovery systems shall be evaluated for use in preconditioning the supply air.
- 7.3.5.3. In equipment rooms, mechanical ventilation shall be provided to limit air temperature rise to roughly 10°F when the room is

unoccupied. When appropriate, provide a wall-mounted supply fan and exhaust fan with motorized dampers. Size ventilation equipment for the greater of a 10°F rise for summer or an air change rate of 10 per hour for winter operations.

7.4. Ground Source Heat Pump Systems

- 7.4.1. Evaluate the use of ground source heat pumps if the facility requires simultaneous heating and cooling and has a minimum cooling capacity of 35 tons.
- 7.4.2. Select high-efficiency heat pumps that use non-CFC and non-HCFC refrigerants.
- 7.4.3. Heat pumps shall be of the extended range type, designed to operate with entering water temperatures in the 32°F to 100°F temperature range.
- 7.4.4. Nontoxic, biodegradable circulating fluids such as propylene glycol/water shall be used.
- 7.4.5. The geothermal bore field design shall be completed by a professionally registered engineer who is accredited by the International Ground Source Heat Pump Association (IGSHPA). The installation of the bore field piping shall be done by a contractor who is installer accredited by the IGSHPA and who has at least two years of successful installation experience with closed-loop ground heat exchanger systems.

10030-8. Supplemental Heating Systems

- 8.1. Cabinet unit heaters shall be mounted in the ceiling, where practical, instead of in the walls.
- 8.2. Unit heaters shall be used for supplementary heat in such areas as mechanical rooms, shop areas, and receiving areas.
- 8.3. Fin tube/radiant ceiling panel heating may be used to provide heat for large exterior exposures. Radiant ceiling panels shall not be used where ceiling heights exceed 12 feet.
- 8.4. Spot heating sources throughout a building may be required and should be evaluated on a case-by-case basis.

10030-9. Heating Fuel Selection and System Design

- 9.1. Fuel selection shall be based on availability at the site. Most remote locations will have either natural gas or liquefied petroleum gas (LPG) available. Fuel oil heating shall not be used.
- 9.2. Natural gas distribution systems shall be located away from loading docks, driveways, sidewall air intake louvers, and other locations where physical damage could occur or where venting could enter the building. Construction documents shall show the location of the gas pressure-reducing valve, the gas meter, and the location where the piping enters the building.

- 9.3.** LPG storage tanks, vaporizers (when required), and distribution systems shall be designed and installed in accordance with NFPA 58 Liquefied Petroleum Gas Code. The site utility plan shall indicate the tank and distribution system location. Detailed drawings shall show the tank, tank support, piping, relief valves, pressure/volume/temperature gauges, vaporizer (if required), emergency shutoff valves, pressure regulator, and security fencing. The Designer of Record shall determine the storage capacity needed for the site location and shall determine if a vaporizer is required based on load requirements and site temperatures.

10030-10. Heating and Cooling Plant Criteria

10.1. General

- 10.1.1.** Identify a centrally located mechanical room on the building's ground floor and at an outside accessible wall location for the heating and cooling mechanical equipment room.

10.2. Heating Plant

- 10.2.1.** A minimum of two hot-water boilers with the following characteristics shall be provided:
- 10.2.1.1.** Gas-fired, atmosphere/forced draft, water tube boilers (80 percent minimum efficiency).
 - 10.2.1.2.** Condensing boilers where they are LCCA justified (90 percent minimum efficiency).
 - 10.2.1.3.** Boilers shall not have aluminum heat exchangers. Propylene glycol systems with inhibitors react with aluminum.
- 10.2.2.** Total heating capacity of the boiler plant shall be approximately 120 percent of the building design load.
- 10.2.3.** Design water supply temperature shall range between 160°F and 200°F. Condensing boilers design supply temperature shall not be greater than 130°F.
- 10.2.4.** Design water temperature drop in the system shall be maintained between 30°F and 40°F.
- 10.2.5.** Heating water distribution loops shall be a reverse return, when feasible.
- 10.2.6.** Steam heating systems in new facilities shall not be used. Specify steam heating only when expanding an existing system and there is no other viable option.
- 10.2.7.** A minimum of two pumps shall be used for water circulation to the building system. It is recommended that the pumps each be sized at 100 percent of the total system flow and pressure. The system shall be designed to maintain the boiler manufacturer's minimum flow requirements.

- 10.2.8.** Antifreeze shall be used in hot water systems in climates with temperatures of +32°F and colder. The design of the heating system shall include a 30 percent solution by volume of inhibited propylene glycol formulated specifically for heating systems. Provide a glycol feed tank and related electric feed pump.
- 10.2.9.** Variable speed pumping above 10 horsepower shall be evaluated for energy-saving potential on the main heating water pumping systems.
- 10.2.10.** Air shall be removed with automatic separators and vents. Manual vents shall be used at high points within the pipe system. To maintain a constant system pressure, each system shall have a bladder-type expansion tank. System static pressure shall be set at 5 pounds per square inch over building height static pressure.
- 10.2.11.** Each system shall be provided with a manual chemical water treatment system to prevent corrosion and scaling in the heating water system.
- 10.2.12.** A combustion air system for each boiler shall be installed to meet the code. Provide a means for preheating the incoming air or maintaining a minimum temperature of 55°F within the boiler room area.
- 10.2.13.** Gas-firing equipment shall be in accordance with NFPA 54 National Fuel Gas Code.
- 10.2.14.** At every point where balancing is required, a flow-measuring device and balancing valve (or a combination thereof) shall be specified and/or shown on the plans. The required length of straight pipe before and after the flow sensor shall be clearly indicated.
- 10.2.15.** Water velocity in water piping shall not exceed 6 feet per second and shall be sized for friction loss not greater than 4.5 feet per 100 feet.
- 10.2.16.** Multi-duty valves and fittings, such as combination shutoff/check/balancing valves at pump discharges and combination suction diffuser/strainers at pump inlets, shall be used where they can simplify piping and reduce costs. The required length of straight pipe before and after the multi-duty valve shall be shown on the plans.
- 10.2.17.** For maintenance purposes, isolation valves shall be provided for isolating each piece of equipment in the system.
- 10.2.18.** Thermal expansion must be considered and accounted for in piping. All piping above ambient temperature must be considered, and calculations for lines above 160°F must be included in the design analysis. Allowable stress ranges are given in ANSI B31.1.
- 10.2.19.** Anchors and guides shall be provided where required by stress analysis.

10.3. Cooling Plant

- 10.3.1.** Chillers shall be packaged units with either water- or air-cooled condensers. Refrigerated split systems shall not be used.
- 10.3.1.1.** Air-cooled condensers shall be used when facility total tonnage is approximately 200 or less.
 - 10.3.1.2.** For tonnages greater than 200, an LCCA comparison between water- and air-cooled condensers shall be completed.
 - 10.3.1.3.** Packaged air-cooled units shall be located outdoors and weatherized in climates colder than 32°F.
 - 10.3.1.4.** Packaged water-cooled units shall be located indoors with a cooling tower located outdoors and weatherized for locations colder than 32°F.
- 10.3.2.** Chiller compressors shall be one of the following types and shall include the following characteristics:
- 10.3.2.1.** Chillers of 130 tons or less shall be scroll or screw (in that order of preference).
 - 10.3.2.2.** Chillers of greater than 130 tons shall be screw or centrifugal (in that order of preference).
 - 10.3.2.3.** Chillers of more than 30 tons shall operate at less than 25 percent design capacity at the lowest step of loading, without using hot-gas bypass.
 - 10.3.2.4.** CFC and HCFC refrigerants shall not be used.
 - 10.3.2.5.** Chillers shall meet the noise criteria levels indicated in Section 7040 of this handbook.
- 10.3.3.** Chillers shall be sized at 100 percent of the building coincident peak design load, design water supply temperatures shall range from 42°F to 48°F, and the system design temperature rise shall be maintained between 12°F and 16°F.
- 10.3.4.** Chilled water distribution loops shall be reverse return, where feasible.
- 10.3.5.** With a single chiller, a single pump shall generally be used for water circulation to the building system.
- 10.3.5.1.** The system pump shall be sized at 100 percent of total flow.
 - 10.3.5.2.** The chilled water system shall be capable of a minimum 50 percent flow reduction. The system shall maintain the chiller manufacturer's minimum flow requirements at all times.
 - 10.3.5.3.** Variable speed pumping for 10 horsepower and larger shall be evaluated for energy-saving potential using the LCCA process.

- 10.3.5.4.** When multiple chillers are used, primary and secondary pumping systems with variable speed pumping shall be used.
- 10.3.6.** Each closed-loop system shall be provided with a manual chemical water treatment system to prevent corrosion and scaling in the chilled water system.
- 10.3.7.** If any part of the chilled water system is exposed to freezing conditions, the chilled water shall be protected with an antifreeze solution similar to the one described for the heating system in 10.2.8, above.
- 10.3.8.** Cooling towers shall be either induced draft (cross-flow) units or forced draft (counter-flow) units.
- 10.3.8.1.** Cooling towers shall be located in areas that optimize their operation and are out of sight of building occupants.
- 10.3.8.2.** Condenser water temperatures shall be selected for efficiency.
- 10.3.8.3.** Cooling towers shall be sized to maintain condenser water temperature to the chillers during a design day with ambient wet-bulb temperatures equal to the 2½ percent design wet-bulb temperature.
- 10.3.8.4.** Capacity reduction methods for cooling towers, such as multiple fans, two-speed fans, variable frequency drives, inlet dampers, condenser water mixing valves, or dump valves, shall be used to maintain condenser water temperature during partial load conditions.
- 10.3.8.5.** A single condenser water-circulating pump shall be used for each water-cooled chiller. Pump components shall be suitable for cooling tower systems.
- 10.3.8.6.** In climates with temperatures below 32°F, a remote sump capable of holding the water for the cooling tower system shall be provided below the cooling tower level within a tempered space, where feasible. If a remote sump is not possible, heat tracing must be provided for exposed piping and for cooling tower sumps exposed to freezing weather.
- 10.3.8.7.** The cooling tower system shall include a makeup water connection that operates automatically through a reduced-pressure backflow preventer.
- 10.3.8.8.** The cooling tower water shall be chemically treated by either manual additions or by an automatic injector water treatment system.

10030-11. Water Quality and Treatment

- 11.1.** A filter/feeder-type manual “shot feeder” water treatment system shall be used for boiler and chiller closed-loop systems. Manual or automatic basin injection water treatment shall be used for cooling towers.

- 11.2. The contractor shall have the makeup water system tested for the following: pH, hardness, calcium, magnesium, alkalinity, chloride, and other materials.
- 11.3. Chemical treatment shall bring the makeup water to the boiler/chiller manufacturer's specifications.

10030-12. Acoustics

- 12.1. An acoustic analysis shall be performed on rotating HVAC equipment and pumps to assure that minimal noise is transmitted to the associated spaces. Refer to Section 7040 of this handbook for additional information.

10030-13. Vibration and Noise Isolation

- 13.1. All air handling equipment, ductwork, and piping systems shall be properly isolated to prevent vibration transmission to spaces. Vibration of equipment shall be within manufacturer's acceptable limits.

10030-14. Seismic Design Requirements

- 14.1. Equipment and distribution systems shall be restrained in accordance with ARCOM MASTERSPEC 23 05 48 Vibration and Seismic Controls for HVAC Piping and Equipment.
- 14.2. Seismic zones shall be determined in accordance with the Chapter 9, "Structural," in this handbook.

10030-15. Testing, Adjusting, and Balancing

- 15.1. All hydronic and air systems shall be tested, adjusted, and balanced in accordance with the National Environmental Balancing Bureau's (NEBB's) Procedural Standards for Testing Adjusting Balancing of Environmental Systems. Additional requirements shall be in accordance with ARCOM MASTERSPEC 23 05 93 Testing, Adjusting, and Balancing for HVAC.

10030-16. System Commissioning

- 16.1. All mechanical systems, including HVAC, plumbing, controls, energy management, and fuel shall be commissioned in accordance with ARCOM MASTERSPEC 23 08 00 Commissioning of HVAC.
- 16.2. Both fundamental and enhanced commissioning, as identified by LEED, are requirements. Enhanced commissioning requires early project involvement by the Commissioning Agent.
- 16.3. An independent third party will be hired by the BIA for each project. The BIA will be responsible for the contracts and direction for the Commissioning Agent.

10040-1. General

- 1.1. All new BIA school facilities shall have a building management system (BMS) that shall control and monitor space temperatures and lighting, and building energy consumption. These systems shall allow facilities operators to monitor and optimize energy performance, to set space temperatures and lighting levels to help remotely troubleshoot problems, and to gather and store operational data for trending.
- 1.2. The building management system shall be direct digital control (DDC), shall operate over the building fiber optic/cabling IT backbone, and shall report to a remote monitoring station. Switching, connection, programming, coordination, and commissioning of the BMS shall be the responsibility of the DDC contractor. Where applicable, monitoring/control points shall be provided on all major equipment. The system shall have a web server and shall be accessible to a minimum of eight users at the same time using a standard browser for monitoring/logging and remote control of systems.
- 1.3. The BMS Designer of Record shall:
 - 1.3.1. Determine the extent of the BMS required by the local BIA site/buildings.
 - 1.3.2. Set goals for the equipment that the BMS should manage based on needs, LEED requirements, and staff capabilities. The system shall be interoperable with site's scheduled and preventive maintenance system.
 - 1.3.3. Design the BMS to maximize environmental comfort and minimize energy use.
 - 1.3.4. Use land-based Internet communication where available; otherwise, satellite communication shall be used.
 - 1.3.5. Provide DDC points, hardware, software, and interface for all equipment to achieve required control, monitoring, and data logging.
 - 1.3.6. Provide a system that logs all readings for water, gas, and electric usage for the building, including renewable energy systems (if provided).
 - 1.3.7. Provide a system with battery backup power (UPS).
 - 1.3.8. Design a system that allows local manual control if the BMS malfunctions.
 - 1.3.9. Provide generic software, diagnostic tools, wiring diagrams, and manuals that are available on the open market. This includes, but is not limited to, a web browser graphic-based operation, archiving alarms, trends and totals, upload and download programs, diagnostics, change-of-state monitoring, scheduling, reporting, alarming, and backup. All software, diagnostic tools, wiring diagrams, and manuals shall become the property of the BIA.
 - 1.3.10. Design the BMS to include alarms that identify equipment malfunction, security breaches (input from the security system), fire and life safety

conditions (inputs from the fire alarm system), and imminent freeze conditions, e.g., pump failure alarm, duct smoke detector, and freestat alarm.

10040-2. Design Documents

- 2.1.** A detailed input/output (I/O) list, flow and control diagrams, and a sequence of operation shall be provided for all major equipment and systems at the Design Development submission. This shall include the items listed below and any additional items requested by the BIA.
- 2.2.** Provide location drawing(s) indicating the location of all control sensors, controlled devices (valves, variable air volume [VAV] boxes, etc.), and control panels.

10040-3. System Requirements

- 3.1.** The control system and documents (I/O list, control diagrams, and sequence of operation) shall include all major equipment and system components, including:
 - Heating plant; including pumps, valves, boilers, etc.
 - Cooling plant; including pumps, valves, chillers, etc.
 - Air handling units and air distribution systems; including VAV boxes, dampers, etc.
 - Ventilation and exhaust systems; including fans, dampers, etc.
 - Terminal heating; including unit heaters, convectors, etc.
- 3.2.** Additional monitoring points shall be as follows:
 - Differential pressure across each filter bank
 - Btuh of the solar radiation available
 - Carbon dioxide sensors in the space to control ventilation
 - Main service electric consumption and demand, and electric consumption at lighting panels
 - Metered gas consumption
 - Temperatures of kitchen coolers and freezers
 - LEED-required monitor points
- 3.3.** Lighting: Refer to Chapter 11, “Electrical,” for additional lighting and lighting control requirements.
- 3.4.** Security (define with project team): Refer to Chapter 13, “Information Technology,” for monitoring requirements.
- 3.5.** Fire alarm system: Refer to Chapter 11.

3.5.1. Monitor inputs from the fire alarm system. While the BMS is not the primary fire alarm reporting system, it should monitor:

- Smoke/fire detectors
- Fire suppression systems
- Fire pump (if needed)
- Emergency generator
- Gas detection alarms

3.6. BMS controls and the equipment within the school building:

3.6.1. Require native standard open protocol communication between controllers and systems, including monitoring. This will be provided over the school facility network and shall be accessible from any computer via a web browser with access to the network. The system will continue to operate in the event of a network failure.

3.6.2. Should include multiple levels of log-on security.

3.6.3. Shall be run over building fiber optic, network wiring, and/or applicable industry standard cabling on the building network with connection to the Internet. All software and hardware interfaces and building controllers shall use a common open standard protocol such as LonWorks, BACnet, or over Ethernet TCP/IP.

10040-4. Testing, Training, Operations, Maintenance, and Warranties

4.1. Provide for complete testing of the entire BMS and submission of results to the Designer of Record and the BIA for review and approval.

4.2. Provide for on-the-job training, where appropriate, for all personnel and staff who will be operating the systems. Training shall be provided at multiple levels appropriate for the staff that will be supporting the systems. Refer to Section 10060, "Training," for further information.

4.3. Operations and maintenance (O&M) for these management systems shall be coordinated with the O&M manuals provided by the equipment manufacturers. The BMS contractor or vendor shall provide the O&M manuals for the specific control systems designed as part of the school project.

4.4. Maintenance contracts shall be provided for one, two, or five years for the complete BMS, all software, etc. (Refer to Chapter 13, "Information Technology," for requirements for routers, servers, fiber optics, cabling, and termination devices.) Computers and other peripheral devices are not required.

4.5. Extended warranties (one, two, or five years) on all hardware and software related to the control system shall be provided. Telephone help and support shall be provided at no cost to the school district for a period of one, two, or five years after formal acceptance of the management system.

10040-5. System Description

- 5.1.** The system architecture shall eliminate dependence on any single device for alarm reporting and control execution. Each DDC controller shall operate independently by performing its own specified control, alarm management, operator I/O, and data collection. The failure of any single component or network connection shall not disrupt the execution of control sequences at other operational devices.
- 5.2.** A stand-alone DDC controller shall perform all required local control functions without the need for communication with a remote supervisor or host computer, shall have a battery-backed clock, and shall contain the necessary resident firmware to provide peer-to-peer communications with other DDC panels. Stand-alone DDC controllers shall be fully custom programmable, with all software functions and modules resident within the controller.
- 5.3.** The design shall be stand-alone and modular to ensure future expansion capability, whether it is additional control/monitoring points or supervisory functions. The system shall be expandable to 1,500 I/O points without additional front-end components and/or software.
- 5.4.** The system shall be fully user programmable.
 - 5.4.1.** The system shall incorporate a software editor that allows online viewing of the DDC programs as they are being executed.
 - 5.4.2.** It shall be possible for the user to copy all parameters and custom software from each DDC panel to tape, CD, or flash memory device for backup without the use of special compilers or engineering software.
 - 5.4.3.** It shall be possible for the user to copy all parameters and custom software to each DDC panel from a local port at each panel, and/or from the operator's terminal, without the need for special engineering software and/or erasable programmable read-only memory (EPROM) chip reconfiguration.
 - 5.4.4.** The database parameters and custom software for each primary DDC panel shall be totally resident within the panel in the form of nonvolatile read/write electrically erasable programmable read-only memory (EEPROM), flash memory, or battery-backed random-access memory (RAM). The use of EPROM for storage of database parameters and/or custom software is not acceptable.
- 5.5.** Provide a separate, stand-alone DDC controller (not application specific) for each air handling unit (AHU) or other HVAC system. It is intended that each unique system be provided with its own resident stand-alone DDC controller. A DDC controller may control more than one air handler, provided that all points associated with any one air handler are assigned to the same DDC controller. Application-specific controllers shall not be utilized except for VAV box controllers, unless specifically approved for use on a given system.

- 5.6. The operator interface system shall be menu driven and shall provide all system, point, and function identifications and status/alarm messages in the English language without the use of cryptic codes.
- 5.6.1. The operator interface system shall be transparent, permitting the user to access any point for status display and/or to change any parameter (set point, etc.) without knowing the physical location of the local panel and/or terminal block connections for the point.
- 5.6.2. All points of the system shall be accessible from the central DDC panel or from the operators' terminals using menus and/or system/point description techniques.
- 5.7. The system shall be tolerant of power failures. Memories shall be nonvolatile, or the unit shall hold a memory up to 48 hours, minimum, on backup batteries. At least one UPS battery-backed (48-hour minimum) real-time clock shall be furnished for each building stand-alone controller. Upon system or power failure, the system shall maintain all DDC control functions in their present position or a fail-safe condition. On power restoration, automatically and without operator intervention, the following restart procedures should be executed:
- Come online
 - Update all monitored functions
 - Resume operation based on current time and status
 - Implement special building start-up strategies as required
- 5.8. The software required to provide the initial operation routines shall not consume more than 70 percent of the programmable capability of the building controllers.
- 5.9. The response time for the controllers to sense an event, make the appropriate calculations, transmit data through the network, and have a remote controller issue the required commands shall be less than the timing requirements to the systems controlled.

10040-6. Energy Management

- 6.1. Demand-limiting programs and optimum start/stop programs shall be considered for each project. Refer to Section 10030 for additional energy management opportunities.

THIS PAGE INTENTIONALLY LEFT BLANK

10050-1. General**1.1. Water Conservation**

- 1.1.1. Maximize water efficiency within the buildings. Employ strategies that in total use 20 percent less than the baseline calculated for the building after meeting the Energy Policy Act of 1992 fixture performance requirements. This is outlined in the U.S. Green Building Council's LEED-NC rating system.
- 1.1.2. Utilize a combination of water-conserving fixtures and equipment, such as low-flow toilets and urinals, low-flow showerheads, and high-efficiency dishwashers and laundry appliances. Low-flow devices can reduce water consumption by 20 percent.

1.2. Solar Energy Domestic Hot Water

- 1.2.1. Evaluate the use of solar energy to generate domestic hot water (DHW). Provide a life-cycle cost analysis (LCCA) for system evaluation.
- 1.2.2. Solar hot water generation maybe the primary source of hot water or it may be used to preheat water for a fuel-fired system.

1.3. Potable Water Systems

- 1.3.1. *Piping System.* Piping materials and sizes shall comply with the recommendations in the Uniform Plumbing Code (used by NFPA 5000). Flow velocities in water pipes shall not exceed 6 feet per second. All piping shall be sloped to permit complete drainage and must be properly supported with allowances for expansion and contraction. Expansion loops or expansion joints and anchor points shall be shown on the plumbing drawings. Piping that is subject to freezing shall be suitably protected.
- 1.3.2. All buildings shall include a potable domestic water system serving all sinks, toilets, showers, food service, custodial needs, hose bibbs, heating and chilled water plant fill systems, and drinking water coolers/fountains. All municipal domestic water entering the building, makeup water for boilers/chilled water systems, and water connections to outside the building shall pass through reduced-pressure backflow preventers to prevent the contamination of indoor potable water.
- 1.3.3. Water distribution throughout the facility shall be through piping systems located above ceilings. Piping shall not be installed under slabs unless accessible for maintenance.
- 1.3.4. Domestic water systems within the building shall be of copper tubing. Use of polyvinyl chloride, chlorinated polyvinyl chloride, or polybutylene material shall not be permitted.
- 1.3.5. Water piping to island sinks shall be in an accessible trench in the floor with a removable cover, in the ceiling space of the floor below, or accessible from a crawl space.

- 1.3.6. The required pressure for operation of the furthest fixture from the incoming service will determine if a pressure booster system will be required. The booster system should be a packaged unit that includes all controls. Provide a constant-speed duplex pump package with bladder-type compression tank to meet the flow requirements.
- 1.3.7. Insulate piping to the minimum requirements of ASHRAE 90.1.
- 1.3.8. Locate the water meter inside the mechanical room unless otherwise directed by the local utility.

1.4. Determining Plumbing Fixture Count

- 1.4.1. The Uniform Plumbing Code shall be used to identify the minimum number of fixtures required for water closets, urinals, drinking fountains and lavatories. The number of required fixtures shall be determined by using the occupant load of the building based upon the minimum exiting requirements indicated in NFPA 101, Life Safety Code. The Uniform Plumbing Code is a derivative of the Uniform Building Code.
- 1.4.2. In the Uniform Building Code, ancillary spaces can be deducted when calculating certain requirements. Because one person (student or staff) cannot occupy two spaces simultaneously, the square footage of ancillary spaces shall not be counted when applying the provisions of the Uniform Plumbing Code.
- 1.4.3. Ancillary spaces in schools shall consist of the following, or similar, types of spaces:
 - Agricultural/economic development classrooms
 - Art, fine arts, or practical arts classrooms
 - Band rooms
 - Business classrooms
 - Computer-aided design classrooms
 - Computer labs
 - Cultural classrooms
 - Dining (cafeteria) rooms
 - Driver's education classrooms (infrequently provided)
 - Exceptional child classrooms
 - Gifted and talented student classrooms
 - Home economics or home living classrooms
 - Industrial arts, electrical, wood, metal, or automotive shops
 - Language laboratories, including tribal language classrooms

- Library/media center
 - Music or choral classrooms
 - Occupational therapy/physical therapy (OT/PT) rooms
 - Science laboratories, including high school biology, chemistry, physics, general science, and earth science
 - Special education resource rooms
 - Special programs classrooms
 - Speech therapy rooms
 - Student testing laboratories or room
- 1.4.4. Ancillary spaces in dormitories consist of the following, or similar, types of spaces:
- Counseling rooms
 - Isolation health care sleeping rooms
 - Practical arts rooms
 - Student activity rooms
 - Student living rooms
 - Study rooms
- 1.4.5. For gymnasiums, the occupancy load, for the purpose of fixture count, shall be calculated at 15 net square feet per person plus the bleacher seating capacity, including wheelchair spaces.
- 1.4.6. Staff occupancy loads in classrooms shall be based on one teacher and one aid, or two staff members.
- 1.5. Plumbing shall not pass through a telecommunication room or an electrical room.

10050-2. Domestic Water Heater Systems

- 2.1. Domestic hot water may be generated from the following systems according to application:
- A fuel-fired water heater with a separate storage tank
 - A fuel-fired water heater with an integral tank
 - A packaged solar domestic hot water system
 - A packaged domestic hot water preheat system coupled with a fuel-fired water heater
 - An instantaneous point-of-use electric water heater for remote locations in a building only

- 2.2. Fuel-fired, copper fin-tube water heaters with separate insulated storage tanks should be used for systems with a large hot water demand, such as dormitories, kitchens, and gyms. DHW heaters serving dormitories and kitchens shall have redundant heating units for each storage tank.
- 2.3. Fuel-fired units with an integral tank shall be considered for use in elementary school applications that do not have dishwashers or locker rooms.
- 2.4. Domestic hot water temperatures shall be 140°F for water storage tanks, 110°F tempered water for lavatories and showers, and 140°F for kitchen equipment.
- 2.5. Thermostatic mixing valves shall be used to maintain a maximum temperature of 110°F to all lavatories and showers.
- 2.6. A hot water recirculating system shall be required if the length of the hot water piping is greater than 50 feet from the heater to the distribution points. A DHW recirculation system shall operate only during periods of building occupancy. This operation shall be controlled by the direct digital control (DDC) system.

10050-3. Waste, Vent, and Stormwater Piping Systems

- 3.1. Below-grade piping materials shall include Schedule 40 polyvinyl chloride with solvent joints or cast iron with hub and spigot fittings.
- 3.2. Plenum and above-grade piping shall be either cast iron with no-hub fittings, with approved hanger spacing, or Schedule 40 polyvinyl chloride. Schedule 40 polyvinyl chloride is not approved for use in a plenum space unless it is wrapped with a fire protective material acceptable to code.
- 3.3. Fill material around piping that is below slab shall be compacted granular type to 95 percent modified Proctor. Piping shall not be installed directly under walls. A minimum parallel distance from a wall to the pipe shall be 3 feet. This space is necessary for repair access.
- 3.4. Acid waste and vent piping that is below grade shall be Schedule 40 polypropylene with fusion joints. All acid waste and vent piping that is above grade shall be Schedule 40 polypropylene with mechanical joints. Acid waste piping in a plenum shall be fire- and smoke-rated polyvinylidene fluoride.
- 3.5. Sewer cleanouts shall be installed at 50 feet on center, and at changes in direction of 90 degrees or more, at the bottom of vertical risers, and as the sewer exits the building.

10050-4. Plumbing Fixtures and Specialties

- 4.1. Water closets shall be white china, standard flush valve, wall hung, and low-water-consumption type.
- 4.2. Urinals shall be white china, standard flush valve, wall hung, and low-water-consumption type.
- 4.3. Lavatories shall have lever handles for hot and cold water and shall be low-water-consumption type.

- 4.4. Showers shall be low-water-consumption, pressure-balanced type.
- 4.5. Drinking water coolers/fountains shall be wall hung and handicapped accessible.
- 4.6. Sinks shall be 18-gauge, 302 or 304 stainless steel.
- 4.7. Science lab sinks shall be piped with acid-resistant materials. Acid neutralization basins shall be located in a safe and accessible location. Preferred locations are in mechanical rooms.
- 4.8. All plumbing fixtures and trim designed or designated for use by the handicapped shall meet Americans with Disabilities Act and Architectural Barriers Act Accessibility Guidelines (ADAABAAG).
 - 4.8.1. When children are primary users, ADAABAAG technical children's guidelines shall be applied to drinking fountains, water closets, toilet compartments, and lavatories and sinks, as well as to elements and operable parts that must be reached and operated, for example shower controls. Water closet arrangement and reach ranges are subdivided into different children's age groupings. ADAABAAG adult anthropometrics apply to students older than 12 years.
 - 4.8.1.1. Lavatories and sinks for children ages 6–12 shall have a frontal approach with a minimum 24-inch-high open knee space and a 31-inch-high, maximum, rim. Those primarily used by children 5 years old and younger, where a 30-inch-by-48-inch clear floor space is available, are permitted to utilize a parallel approach without a knee space.
 - 4.8.2. "Dual accessibility," arranging fixtures to dually serve the anthropometrics of more than one age group, for example using a single accessible water closet and stall to serve both ages 5–8 and ages 9–12, or to serve ages 9–12 and older students ("adult" anthropometrics), will be allowed as authorized. All installation ranges, such as water closet centerline dimension, toilet seat height, dispenser location, and stall horizontal and toe clearances, must have dimensions that are common to each age group. Two sets of grab bars would be needed to dually serve children ages 9–12 and older students.
 - 4.8.2.1. Spaces involving use by children 12 years old and younger, and by adult staff (and/or students older than 12), shall have two sinks to meet both sets of anthropometrics.
 - 4.8.2.2. Spaces involving use by children 12 year old and younger, and by adult staff (and/or students older than 12), shall have three drinking fountains available—a children's fountain, a fountain that is wheelchair accessible in accordance with ADAABAAG requirements, and a drinking fountain for standing persons.

- 4.8.2.3. A children's accessible drinking fountain shall have a maximum 30-inch above finished floor spout height; the spout shall be 3½ inches maximum from the front edge of the unit, including bumpers. A parallel approach (without knee space) is permitted.
- 4.8.2.4. The drinking fountain for standing persons shall have its spout outlet between from 38 inches to 43 inches above the finish floor or ground.
- 4.8.3. When sinks are provided within accessible spaces, i.e., classrooms, laboratories, laboratory preparation rooms, home economics areas, nurses' offices, dormitory kitchenettes and living rooms, teachers' workrooms, media center storage/workrooms, and concession areas and concession storage rooms, at least one sink shall be provided compliant to ADAABAAG adult technical specifications. In other than common use areas, work surface knee spaces may be arranged as "adaptable," capable of being readily altered to accommodate the needs of disabled persons. Adaptability may not be used in common use areas such as teachers' workrooms, dormitory kitchenettes and living rooms, media center circulation areas, media center storage/workrooms, or concession areas and concession storage rooms. The adaptability concept may not be used for student applications.
 - 4.8.3.1. **Note:** Knee space adaptability involves the capability of removing cabinetry without relocating sinks or work surface countertops.
- 4.8.4. When a common-use single unisex toilet room serves an administrative office area, it shall contain not more than one lavatory and shall contain one water closet and one urinal.
- 4.9. Water supply (hot and/or cold) to the lavatories, sinks, and drinking fountains shall have angle stops with loose key handles.
- 4.10. All wall-hung lavatories, water closets, and urinals shall have chair carriers.
- 4.11. Floor drains shall be installed in each large group restroom, locker room, mechanical room, and kitchen area. Provide a sediment bucket in floor drains where conditions are such that solids may enter the drain.
- 4.12. Showers shall have a hot and cold, single-lever pressure balancing valve with a vandal-resistant head.
- 4.13. Service sinks shall be floor-mounted, molded stone, 10 inches high, with a wall-mounted faucet.
- 4.14. A cold water hose bibb shall be installed in each large group restroom, locker room, and mechanical room. The hose bibb shall be behind a lockable door in restrooms and locker rooms.
- 4.15. If outside potable water pressure exceeds 80 pounds per square inch, a water-pressure-reducing station with two pressure-reducing valves sized for 1/3 and

2/3 flow shall maintain the water pressure in the building to a maximum of 80 pounds per square inch.

- 4.16. Clay traps shall be provided in art rooms to prevent clay and solids from entering the sanitary sewer. The clay trap shall be accessible for cleanout.
- 4.17. Trap primers shall be required on all floor drains. Trap primers shall be accessible for repair.

10050-5. Plumbing Systems for Food Service Areas

- 5.1. The ware washing system shall have a booster heater to provide 180°F water.
- 5.2. Provide a three-compartment sink.
- 5.3. An interceptor shall be required (per the Uniform Plumbing Code) to receive the drainage from fixtures and equipment with grease-laden waste located in food preparation areas. Fixtures not requiring an interceptor shall discharge separately and downstream of the interceptor. Where food waste grinders connect to grease traps, a solids interceptor shall separate the discharge before connecting to the grease interceptor. The grease interceptor shall be located on the exterior of the building and will be sized for a 500-gallon minimum capacity, constructed of concrete, with access to grade. The minimum distance from the building to the interceptor shall be 10 feet.
- 5.4. Provide 140°F water to all kitchen equipment and 110°F water for hand-washing lavatories.

10050-6. Gas Piping Systems

- 6.1. Low-pressure gas piping (14 inches of water column and less) shall be Schedule 40 carbon steel with screw fittings for piping 1½ inches or less and welded fittings for piping 2 inches or larger.
- 6.2. Gas piping in plenums shall not contain valves or unions and shall have welded joints.
- 6.3. A gas regulator shall be provided to maintain the correct inlet pressure to each gas appliance. The inlet piping at each regulator shall be valved with American Gas Association approved valves.
- 6.4. The maximum gas pressure into the building shall be as established by the local gas company. Provide the gas company with the gas load for each appliance, as well as the minimum and maximum operation pressures for each appliance as early in the design process as possible.
- 6.5. Provide a valve and a dirt leg at each appliance connection.
- 6.6. Natural gas piping to island sinks shall be in an accessible trench in the floor, with a removable cover.
- 6.7. The gas supply to science rooms and art rooms shall have an emergency solenoid-type automatic shutoff valve with a keyed manual reset. The purpose

of the valve is for shutdown of the gas in case of an emergency or when the fire alarm system is activated.

- 6.8.** A solenoid-type automatic shutoff valve with a manual reset shall be provided for all equipment located under kitchen hoods for safety in the event there is a fire under the hood. Such valves are designed to be normally closed unless they are held open by an electric solenoid valve. A mushroom-type wall switch shall be located in the room for solenoid activation as well as interlocked with the hood fire suppression system.

10050-7. Valving

- 7.1.** Valves shall be installed to isolate individual plumbing fixtures and groups of plumbing fixtures to permit shutdown of the fixture or equipment item without affecting the remainder of the building.
- 7.2.** The domestic water system valves shall be bronze construction with ball-type conventional ports up to and including 3-inch piping. Piping 4 inches or larger shall have a butterfly valve.

10050-8. Hangers

- 8.1.** Provide hangers for all horizontal, suspended, domestic water, gas, sanitary, and storm piping with distances as noted in the state and local codes.

10050-9. Identification

- 9.1.** Piping shall be identified for the type of service and direction of flow. Equipment shall be identified with nameplates.

10060-1. General

- 1.1. Training requirements for mechanical systems shall be coordinated with the BIA. The extent of training should be based on the needs of the installation personnel. The following shall be used as a guideline for each project, filling in the appropriate quantities.

1.1.1. Training Course Requirements

- 1.1.1.1. A training course shall be conducted for [____] operating staff members designated by the Contracting Officer in the maintenance and operation of the system, including specified hardware and software.
- 1.1.1.2. The training period, for a total of [____] hours of normal working time, shall be conducted within 30 days after successful completion of the commissioning.
- 1.1.1.3. The training course shall be conducted at the project site.
- 1.1.1.4. Audiovisual equipment and [____] sets of all other training materials and supplies shall be provided.
- 1.1.1.5. A training day is defined as 8 hours of classroom instruction, including two 15-minute breaks and excluding lunchtime, Monday through Friday, during the daytime shift in effect at the training facility.

1.1.2. Training Course Content

- 1.1.2.1. For guidance in planning the required instruction, the contractor shall assume that attendees will have a high school education or equivalent, and are familiar with HVAC systems.
- 1.1.2.2. The training course shall cover all the material contained in the operations and maintenance instructions, the layout and location of each HVAC control panel, the layout of one of each type of unitary equipment and the locations of each, the location of each control device external to the panels, preventive maintenance, troubleshooting, diagnostics, calibration, adjustment, commissioning, tuning, and repair procedures. Typical systems and similar systems may be treated as a group, with instruction on the commissioning report to be presented as benchmarks of HVAC control system performance by which to measure operation and maintenance effectiveness.

THIS PAGE INTENTIONALLY LEFT BLANK

11000-1. Introduction

- 1.1. This chapter shall be used as a guideline in the development of power, lighting, grounding, fire alarm, lightning protection, and other electrical systems for all new BIA school facility projects. The design shall be in conformance with these guidelines unless exceptions to them are granted by the BIA.
- 1.2. Refer to Chapter 1, “General Information,” and Chapter 2, “Presentation of Data,” for required documents, drawing and specifications formats, and other design and submittal requirements not discussed in this chapter.
- 1.3. Additional design and submittal requirements may apply for projects with unusual or highly technical criteria.
- 1.4. As applicable, the Designer of Record shall incorporate the sustainability strategies identified in Chapter 3, “LEED Goals and Guidelines.”
- 1.5. The guidelines in this chapter should be used in conjunction with those in the other chapters in this handbook, and the Designer of Record should coordinate with the other project consultants to be sure all aspects of the school facility are effective and compatible.
- 1.6. All design features must be weighed carefully for their initial cost, long-term maintenance cost and needs, durability, and their impact on the environment.

11000-2. Documents**2.1. Specifications**

- 2.1.1. Performance specifications shall be provided for lightning protection systems only.
- 2.1.2. Avoid specifying a system or equipment manufactured by a single manufacturer.
- 2.1.3. If a particular product is required due to design constraints, notify the BIA and provide recommendations for how to accommodate the situation.
- 2.1.4. Do not specify foreign products or components manufactured to foreign standards.

2.2. Design Calculations**2.2.1. Required calculations include:**

- Lighting levels as noted in the lighting sections. (The text height on submitted lighting level plans shall be 8 point or 1/16 inch, minimum.)
- Voltage drop.
- Demand loads on panelboards, main service, etc. Include diversification per the National Electrical Code (NEC).
- Phase balancing on panelboards.

- Available short-circuit currents.
- Coordination study.

2.3. Submittals

- 2.3.1. Submit the calculations noted above with the construction documents for review at each of the various stages of project submittal and review.
- 2.3.2. Provide catalog data sheets for equipment specified in the construction documents with the construction documents for review at each of the various stages of project submittal and review.

11000-3. Quality Control

- 3.1. Quality control review shall include, but not be limited to, the following:
 - 3.1.1. Perform a complete, independent review for errors, omissions, or conflicts within and between disciplines.
 - 3.1.2. Verify that equipment locations are indicated.
 - 3.1.3. Verify that all equipment indicated on schedules, one-line diagrams, etc., is indicated on the plans.
 - 3.1.4. Verify that callouts are provided for each piece of equipment.
 - 3.1.5. Verify that equipment clearances and headroom meet NEC requirements.
 - 3.1.6. Verify that no ducts or piping are routed over electrical equipment.
 - 3.1.7. Coordinate ceiling-mounted lights, grilles, fire alarm equipment, etc., so that they are not in conflicting locations.
 - 3.1.8. Motor requirements:
 - Match the callouts and requirements indicated in other disciplines.
 - Verify that all motors are shown on the plans and schedules.
 - Verify that phase and voltage requirements are correct.
 - Verify that starters are appropriate for the motors.
 - Verify that variable frequency drive (VFD) feeders are sized per the NEC and manufacturer's recommendations.
 - Verify that a local disconnect is provided for all motors.
 - Verify that power has been provided to all control panels.
 - Verify that power has been provided to all motorized dampers requiring line voltage.
 - Verify that a receptacle has been provided within 25 feet of roof- and exterior-mounted mechanical equipment.

- 3.1.9.** Verify that the National Electrical Manufacturers Association (NEMA) enclosures called out match the environment they are to be installed in.
- 3.1.10.** Verify that motorized doors and their associated controls are indicated on the plans and match the architectural requirements.
- 3.1.11.** Verify that the legend matches the symbols used on the plans.
- 3.1.12.** Light fixture requirements:
- Verify that fixture symbols indicated on the plans match the schedule callout.
 - Verify that all fixture types indicated on the plans are called out on the schedule.
 - Verify that lighting controls are provided for all areas and rooms.
 - Verify that egress lighting meets code requirements.
 - Verify that exit signs are provided per code for all paths of egress.
- 3.1.13.** Verify that special systems power requirements are indicated and coordinated.
- 3.1.14.** Verify that power has been provided to fuel storage leak detection equipment.
- 3.1.15.** Verify that no sole-source equipment has been specified without BIA authorization.
- 3.1.16.** Verify that the design meets the scope of work.
- 3.1.17.** Verify that the design complies with the design guideline requirements.

11000-4. Building Types

- 4.1.** Designs shall be modified as appropriate for code compliance and best practices for the building type. Possible building types include:
- Elementary school
 - Middle school
 - High school
 - Boarding school
 - Bus garage
 - Maintenance building
 - Kitchens
 - Fields (baseball, football, track, etc.)

11000-5. Local Availability

- 5.1.** Verify local availability of spare parts, replacement parts, and service technicians for the equipment specified.
- 5.2.** If equipment is not locally available, determine the response time for obtaining it and verify with the BIA that the amount of time is acceptable.

11000-6. Warranty

- 6.1.** A minimum of a 1-year warranty from successful start-up shall be provided for all systems.
- 6.2.** Additional or extended warranties are noted in other sections of this chapter.
- 6.3.** Labor warranty work shall be performed by factory-trained service technicians located within 50 miles of the project site or a distance as appropriate to the site.

11010-1. Systems Evaluation

1.1. Electrical systems for BIA school facilities shall be evaluated based on the following criteria. The list is in order of priority, and each criterion is followed by additional information applicable to it.

1.1.1. Critical Building Systems

- The more critical the system, the more infallible it shall be.
- If a system is determined to be essential to the operation of the building, consideration shall be given to providing redundancy to the system.

1.1.2. Standardization

- The design shall follow BIA standards.

1.1.3. Training Standardization

- Systems requiring less training are preferred.

1.1.4. Operations and Maintenance Concerns

- Systems requiring less maintenance are preferred.

1.1.5. Limitation of Flexibility/Creativity

- System designs shall be well established within the industry.
- The systems designed shall be similar to systems in comparable buildings at other BIA facilities that were also designed according to the guidelines in this handbook.

1.1.6. Available Infrastructure

- The available utilities shall be coordinated with the specific project site at the beginning of the project to ensure that the systems specified can be supported by the local utilities.

1.1.7. *Cost.* The life cycle cost analysis of the systems shall include the following:

- Construction costs
- Operating costs
- Maintenance costs

1.1.8. Constructability

- Ease of construction of the proposed system shall be considered.
- The availability of workers skilled in the installation of a proposed system shall be considered.

1.1.9. LEED

- Where system selection affects compliance with a LEED credit point, the system shall be designed as required to meet the LEED requirements.

1.1.10. Commissioning

- Systems requiring less commissioning are preferred.

1.1.11. Site Constraints and Criteria

- The system proposed shall be compatible with site constraints and requirements, including exposure to hazards such as lightning, earthquakes, and flooding, as well as geography, elevation, and other local conditions.

1.1.12. Climate Influences

- The system proposed shall be compatible with the climate of the project site.

1.1.13. Infrastructure Flexibility/Expandability

- The system design shall be able to accommodate future expansion as required by the BIA.

- 1.2.** Where a clear system selection is *not* readily determined by examining the above criteria, present the information available, relative to those criteria, to the BIA for review and selection.

11020-1. General

- 1.1. The electrical design for BIA school facilities shall comply with all applicable current codes, standards, and laws. For a more general list of codes and standards that apply to BIA educational facilities, refer to Chapter 1, “General Information.” During design, report any required deviations from codes and standards to the Contracting Officer.
- 1.2. Where two codes, standards, or laws are applicable to the topic under review, use the more conservative or more stringent. Consult with the BIA Office of Facilities Management and Construction (OFMC) to resolve any questions or conflicts regarding application of codes and standards.
- 1.3. The National Fire Code (NFPA 5000) is the primary code to be followed.
- 1.4. Per Chapter 48 of NFPA 5000, the National Electrical Code (NEC) shall be followed for the design and installation of all electrical equipment unless the requirements of the codes noted below are more stringent.
 - 1.4.1. All requirements noted in the NEC shall be followed, including mandatory, recommended, and advisory rules.

11020-2. Applicable Codes and Standards

- 2.1. The design criteria shall comply with the guidelines published by or contained in the following:
 - American National Standards Institute (ANSI)
 - American Society of Heating, Refrigerating and Air-Conditioning Engineers (ASHRAE) 90.1 Energy Standard for Buildings Except Low-Rise Residential Buildings
 - American Society for Testing and Materials (ASTM)
 - Americans with Disabilities Act and Architectural Barriers Act Accessibility Guidelines (ADAABAAG)
 - ANSI/American Society of Mechanical Engineers (ASME) A17.1 Safety Code for Elevators and Escalators
 - Illuminating Engineering Society of North America (IESNA)
 - Institute of Electrical and Electronics Engineers (IEEE)
 - Insulated Cable Engineers Association (ICEA)
 - Leadership in Energy and Environmental Design (LEED)
 - Lightning Protection Institute (LPI)
 - NACE International
 - National Electrical Manufacturers Association (NEMA)

- National Fire Protection Association (NFPA), in general and specifically:
 - NFPA 70 National Electrical Code
 - NFPA 70E Standard for Electrical Safety Requirements for Employee Workplaces
 - NFPA 72 National Fire Alarm Code
 - NFPA 75 Standard for the Protection of Information Technology Equipment
 - NFPA 110 Standard for Emergency and Standby Power Systems
 - NFPA 111 Standard on Stored Electrical Energy Emergency and Standby Power Systems
 - NFPA 170 Standard for Fire Safety and Emergency Symbols
 - NFPA 780 Standard for the Installation of Lightning Protection Systems
 - NFPA 5000 Building Construction and Safety Code
 - Occupational Safety & Health Administration (OSHA)
 - Section 504, Rehabilitation Act of 1973, as amended in 1978
 - USCA Title 29 § 794, “Nondiscrimination under Federal Grants and Programs”
- 2.2.** Design of the electrical system shall be such that ADAABAAG requirements are met for device mounting heights, protrusions, lighting, etc.
- 2.2.1.** When children are primary users of accessible space, for example in accessible dormitory rooms to be assigned to persons 3–12 years of age, lights switches and electrical receptacles for their use shall be mounted within ADAABAAG children reach ranges in accordance with applicable age groupings.
- 2.2.1.1. Note:** “Dual accessibility,” arranging fixtures to dually serve the anthropometrics of more than one age group, could diversify space use. For example, mounting elements at reach range heights common to both 5–8 and 9–12 age groups will provide occupancy flexibility.
- 2.3.** Seismic restraint requirements shall be coordinated with the individual site. Local seismic codes shall be considered the minimum requirements.
- 2.3.1.** When required for site conditions, fabrication details including anchorages and attachments to structure for large electrical equipment and supported cable trays shall be signed and sealed by a qualified engineer.

11020-3. Equipment Requirements

- 3.1.** All electrical components, devices, and accessories shall be Underwriters Laboratories (UL) listed and labeled as defined in NFPA 70, Article 100, and marked for the intended use.
- 3.2.** All equipment and materials shall be new and unused and shall be in conformance with the current applicable industry standards unless reuse of the equipment is permitted by the BIA.

THIS PAGE INTENTIONALLY LEFT BLANK

11030-1. Utility Coordination

- 1.1. Verify that there is sufficient capacity on the utility distribution line to the project site to accommodate the full design demand load and future projected loads. If sufficient capacity is not available:
 - Notify the BIA immediately.
 - Determine potential options, for review by the BIA, for obtaining the required power from the utility company.
 - Provide to the BIA cost estimates for potential options.
- 1.2. Coordinate the routing of the utility feed to the site and on the site.
 - 1.2.1. Route feeders underground wherever possible.
 - 1.2.2. Coordinate with the local utility company for overhead or underground feeder routing.
 - 1.2.3. Except for crossings, do not route feeders under streets or sidewalks.
- 1.3. Coordinate the exact location of the utility transformer on the site. Verify with the utility company the required separation distances and other requirements for transition boxes, exterior current transformer (CT) cabinets, manholes, duct sizes, conductors, etc.
- 1.4. All medium-voltage service equipment and feeders shall be provided and maintained by the utility company wherever possible.
- 1.5. The one-line diagram shall clearly indicate what equipment is to be provided by the utility company and what equipment shall be provided by the contractor.
- 1.6. Obtain an estimate for the utility connection, including the transformer and pad, utility poles, service drop, CTs, meter, etc., for inclusion in the construction cost estimate.
- 1.7. Include the following in the project specifications *and* on the drawings:
 - 1.7.1. The contractor shall coordinate with the utility company for exact installation requirements.
 - 1.7.2. The contractor shall be responsible for submitting drawings to the utility company for approval and coordination.
 - 1.7.3. The contractor shall pay all material and labor costs required for the installation of the utility connection. This shall include all costs incurred by the contractor *and* by the utility company. The BIA shall not be separately billed for utility connection costs.

11030-2. Reliability

- 2.1. Investigate with the utility company the history, reliability, voltage regulation, and quality of power at the proposed site.

- 2.1.1. Obtain the five-year history of outages at the site. Include the number, duration, time, date, and cause of each for review by the BIA.
- 2.1.2. Develop a probability analysis for the likelihood of future outages of 1, 5, 10, 30, and 60 minutes or longer.
- 2.1.3. Establish the nominal voltages anticipated at the site.
- 2.1.4. Determine if there are any impacts on the reliability of the system based on weather conditions.
- 2.1.5. If the required information is not available from the utility company, coordinate with the BIA to obtain power outage information from schools located near the new building site.
- 2.2. Based on the reliability information and remoteness of the new building site, make a recommendation to the BIA about the requirements for emergency and standby power. Refer to Section 11110, "Emergency and Standby Power Systems," for additional information.

11030-3. Renewable Energy

- 3.1. Per the U.S. Department of Energy (DOE), a minimum of 3 percent of the building power shall be provided by renewable energy.
 - 3.1.1. Refer to the DOE state energy alternative website for site-specific information regarding wind and solar resources.
 - 3.1.2. Refer to other web-based design tools for assistance in estimating potential renewable power at specific locations.
 - 3.1.3. Green (wind) power may be purchased from the utility company to meet the renewable energy requirement.
- 3.2. The amount of renewable power provided shall be metered and monitored via the direct digital control (DDC) system for Internet monitoring.
- 3.3. Coordinate with the local utility company for available incentives for renewable power installations or energy-saving designs.
- 3.4. Coordinate with the local utility company for required disconnecting means and/or protective relaying requirements to prevent backfeeding the utility lines when maintenance is required.
- 3.5. Integration of renewable energy systems shall be included early in the design process to facilitate the integration of the system into the building envelope.
 - 3.5.1. Building-mount renewable energy systems where possible to save land. Suggested locations include on the roof, as daylighting shades, walkway covers, parking lot shades, etc.
- 3.6. Battery backup of renewable energy systems is not recommended due to cost and maintenance, unless the system is required in a remote location and/or no other power source is provided to the building or device.

3.7. Photovoltaics

- 3.7.1.** Photovoltaics are particularly recommended for cool, dry climates and areas of high solar gain. Each site shall be evaluated for the appropriateness of photovoltaics, and a recommendation shall be provided to the BIA on whether or not to include them in the design.
- 3.7.2.** Building-integrated solar modules shall be provided to conserve land whenever possible. Some options for incorporating photovoltaics into the building include:
- An array used as a covered walkway or shading device.
 - A solar carport where photovoltaic cells are used as shading for parking areas.
 - A solar roof where photovoltaic cells are used as the roof structure for a building. Caution shall be used when designing support structures for a solar roof assembly. Keep in mind the following:
 - The structure could produce a waterproofing issue.
 - Where possible, the structure should be designed to allow for easy removal for roof replacement.
 - Coordination with the structural engineer is required for this type of installation.
- 3.7.3.** Photovoltaic systems shall be located to maximize the amount of insolation on the system.
- 3.7.3.1.** The location for the photovoltaic system shall be selected so as to maximize the southern exposure of the system and guard against shading.
- 3.7.3.2.** Verify that no obstructions interfere with the summer and winter sun paths to the photovoltaic system.
- 3.7.3.3.** Coordinate with the landscape architect to ensure that tall trees are not located where they will throw shade on the system in the future.
- 3.7.3.4.** Coordinate the location of the system with the site master plan to prevent shading from future building installations.
- 3.7.4.** Consideration shall be given to stand-alone photovoltaic systems for small, remote loads where a stand-alone system may be more cost effective than wiring back to the distribution system.
- 3.7.4.1.** Parking, walkway lighting, caution lights at street crossings, school zone flashers, security lights, emergency (EM) telephone call boxes, remote signage, etc., are examples of potential stand-alone systems.
- 3.7.4.2.** Battery storage is required for stand-alone systems as noted in paragraph 3.6, above.

3.7.5. Additional maintenance is required for photovoltaic systems. This should be discussed with the BIA prior to including photovoltaics in the design.

3.7.5.1. Typical maintenance includes occasional cleaning and inspection, verification that connections are corrosion free, the modules are clear of debris, and the mounting equipment is tight. To maximize power generation, the modules would also require snow removal.

3.7.6. The warranty period for any photovoltaic system provided shall be a minimum of 20 years.

3.8. Wind Power

3.8.1. Wind power can be cost effective where the average wind speed is 10 to 14 miles per hour.

3.8.2. Wind power can be used for electricity generation or well-water pumping.

3.8.3. The exact location for a wind turbine shall be selected to avoid noise concerns.

3.8.4. Tall towers must be allowed in the area and space must be available on-site for a wind turbine to be viable.

3.8.5. Some utilities have a limitation on the amount of power that may be connected to the grid. Coordinate with the local utility company for maximum allowable power generation.

3.8.6. Wind turbines shall not be located on the roof of a building due to transmission of vibrations to the structure.

3.8.7. The payback period for a wind turbine shall be calculated to help determine if a wind turbine shall be included at a particular site. The calculated payback period shall be specific for the site and shall include a consideration for the optimal tower mounting height.

3.8.8. Additional maintenance is required for wind turbines. This should be discussed with the BIA prior to including wind turbines in the design.

3.8.8.1. Tilt-down towers are easier to maintain and should be favored where practicable.

3.9. Where on-site power generation is provided, labeling shall be provided at the point of connection to the normal power distribution system indicating that multiple power supplies are connected to the equipment.

3.10. Where on-site power generation is provided, the space for inverters or other support equipment shall be indicated on the electrical plans.

3.11. Where on-site power generation is provided, an educational display shall be provided.

11030-4. Daylighting

- 4.1.** Daylighting shall be incorporated into each building design wherever possible, due to the quick payback period and energy efficiency of the systems, but is not considered as a renewable energy source.
- 4.2.** Refer to Section 11060, “Interior Lighting Systems,” for additional information and requirements.

11030-5. Cable Television, Telephone, Data

- 5.1.** Refer to Chapter 13, “Information Technology,” for additional information and infrastructure requirements.

THIS PAGE INTENTIONALLY LEFT BLANK

11040-1. Service Entrance

- 1.1. Locate the service entrance to the building close to utility service approach for easy connection and coordination.
 - 1.1.1. Coordinate with the local utility company for exact requirements.
 - 1.1.2. Coordinate the location of the utility service, transformer, current transformer (CT) cabinet, and meter with the utility company.
 - 1.1.3. Minimize the aesthetic impact of the utility equipment on the building.
- 1.2. Determine if additional transition boxes or other equipment are required by the utility company.
- 1.3. Provide non-reinforced concrete cable duct with minimum 4-inch, Schedule 80 PVC conduits for underground primary and secondary feeders located under roadbeds or where subject to damage or mechanical injury.
 - 1.3.1. Provide a minimum of one spare 4-inch conduit in the cable duct and one additional spare conduit for every four conduits required.
 - 1.3.2. All elbows and risers shall be PVC-coated rigid galvanized steel conduit.
 - 1.3.3. Underground splices are not permitted except in manholes, vaults, etc.
- 1.4. Provide a 480-volt, 3-phase distribution system, unless 3-phase power is not available at the site or the service size is small.
 - 1.4.1. All buildings with service of greater than 200 amps, including outbuildings, shall be 3-phase where available.
 - 1.4.2. A minimum of a 3-wire, 120/208-volt panelboard shall be provided for any building with more than one circuit required.
 - 1.4.3. Provide a single-point disconnecting means for an *entire* campus when required by the BIA.
- 1.5. The electrical service shall be sized to accommodate future expansion and phasing in addition to spare capacity as prescribed in this and other sections of this handbook.
 - 1.5.1. If the project includes future growth or phasing that will require additional utility and service equipment, the construction documents shall address only the current construction with minimal expense for future or phased work.
 - 1.5.1.1. Exception: If the future construction will follow very closely the end of the current construction or if expressly authorized by the BIA.

11040-2. Space Coordination

- 2.1. Coordinate with the design architect to ensure adequate space is provided for all electrical equipment, including switchboards, panelboards, transformers,

lighting contactors, transient voltage surge suppressor (TVSS) equipment, disconnects, etc.

- 2.2. Coordinate with the design architect for any chase or riser requirements for all conduit systems, including power, telecom, fire alarm, security, etc.

11040-3. Metering

- 3.1. Provide metering as required to meet LEED requirements.
- 3.2. Coordinate with local utilities for utility metering requirements.
 - 3.2.1. It is recommended that the utility company meter be located outside the building for access by the utility company.
 - 3.2.2. Determine whether CT cabinets are to be located inside or outside the building.
- 3.3. The main distribution panel (MDP) shall be provided with digital metering for amperage, watts, voltage, power factor, etc., and shall be tied to the direct digital control (DDC) system for monitoring.
- 3.4. Each building shall be separately metered either by the utility company or by owner-provided metering equipment.
- 3.5. Provide metering for motor control centers (MCCs) for potential load shedding via DDC controls.
- 3.6. Provide 3/4-inch conduit from the gas meter(s) to the main telecom room.
- 3.7. Provide 3/4-inch conduit from the water meter(s) to the main telecom room.
- 3.8. Provide 3/4-inch conduit from the electric meter(s) to the main telecom room.

11040-4. Service Distribution

- 4.1. Distribution shall be via switchboards.
- 4.2. Bus bars shall be copper.
- 4.3. Provide a lightning arrester at the MDP.
- 4.4. Provide surge suppression at the MDP.
- 4.5. Provide surge suppression at all distribution boards.
- 4.6. Provide 50 percent spare capacity, 30 percent spare space. Ask about anticipated future expansion that could be accommodated in the original design.
- 4.7. Provide ground fault circuit interrupting (GFCI) protection for equipment rated 1,000 amps or larger.
- 4.8. Specify an MCC where six or more 3-horsepower or larger motors are grouped.
- 4.9. Verify that sufficient space is available for equipment supplied by any of three separate manufacturers. The design shall be based upon the footprint, height, depth, etc., of the largest representation of the equipment type.

- 4.10. Feeders to panelboards shall be sized to match the panelboard bus rating and shall have 200 percent neutrals where feeding nonlinear loads.
- 4.11. Verify the future connection requirements to portable buildings, if required.
- 4.12. Elevator(s) shall be fed from the MDP.
- 4.13. Do not locate the MDP in a mechanical heating or cooling room or generator room. Provide a dedicated electrical room for distribution electrical equipment.
- 4.14. Provide equipment fully rated for the available fault current.

11040-5. Grounding

- 5.1. Refer to Section 11050, "Grounding System," for additional information.
- 5.2. Refer to Section 11120, "Lightning Protection," for additional information.

11040-6. Panelboards

- 6.1. Provide 25 percent spare space and capacity, minimum, for future growth.
- 6.2. The loading of each phase of the panelboards shall be balanced to within 10 percent.
- 6.3. Provide bolt-on molded-case circuit breakers of minimum 20-amp size, unless 15-amp size is required for feeding a motor.
- 6.4. Provide a maximum of 42 breakers per panel. Discuss any unusual circumstances requiring more breakers with the BIA.
- 6.5. Provide door-in hinged-front cover construction.
- 6.6. Provide an insulated neutral and ground bus bar in each panelboard.
- 6.7. The minimum amps interrupting capacity (AIC) rating shall be 10,000 for 208-volt panelboards and 14,000 for 480-volt panelboards.
- 6.8. Panels located in public locations shall be lockable. All panels shall be keyed alike. Furnish a minimum of two keys per each lock installed.
- 6.9. Recess-mount panelboards except in an electrical or utility space and unless prohibited by special circumstances (e.g., a fire-rated wall). Discuss unusual circumstances with the BIA.
- 6.10. Provide sufficient access and working space per the NEC and as required to maintain safe working conditions.
- 6.11. Provide a separate panelboard for communication closets.
- 6.12. Providing a separate panelboard for computer rooms and labs with 12 or more computers.
- 6.13. Provide NEC-required calculations on panel schedules for all panelboards.
 - 6.13.1. Indicate the panel name, voltage, phase, amperage, AIC, and from where the panel is fed.

- 6.13.2.** Indicate all branch loads on each circuit. Note the type of load served and the associated room numbers.
- 6.13.3.** Note spare circuits.
- 6.13.4.** Note available breaker space.
- 6.13.5.** Indicate as “Non-usable” any spaces that are not usable due to obstructions, bus configuration, etc.
- 6.14.** Provide surge suppression equipment for panels feeding communication rooms, a fire alarm control panel (FACP), sensitive electronic equipment, or computers.
- 6.15.** Provide equipment fully rated for available fault current.

11040-7. Transformers

- 7.1.** Insulation class shall be 220°C with all insulation materials flame-retardant and unable to support combustion as defined in ASTM Standard Test Method D635. The maximum rated temperature rise shall be 115°C above 40°C.
- 7.2.** Provide high-efficiency, Energy Star–rated transformers. Transformers shall be K-rated or harmonic cancelling where connected to nonlinear loads.
- 7.3.** Provide six 2.5 percent taps, two above and four below normal full capacity.
- 7.4.** The sound level rating shall not exceed those listed in NEMA TR 1 Transformers, Regulators, and Reactors.
- 7.5.** Provide vibration isolations pads for all transformers, along with rubber washers for all mounting bolts.
- 7.6.** Where transformers are wall-mounted, provide factory mounting brackets.
- 7.7.** Do not locate power transformers of more than 5kVA above ceilings.

11040-8. Raceway Systems

- 8.1.** Provide separate, complete raceway systems for 120-volt, 277-volt, lighting, power, emergency power, standby power, fire alarm, communications, security, audio/visual, public address, and mechanical control cabling. Mingling of conductors shall not be permitted.
- 8.2.** All wiring shall be installed in metallic raceways unless noted otherwise.
- 8.3.** Minimum conduit size shall be 3/4-inch.
- 8.4.** Metallic rigid conduit options include:
 - Intermediate
 - Rigid metal
 - Rigid galvanized metal
 - Electrical metallic conduit
- 8.5.** Flexible conduit must be:

- Liquid-tight
- Steel
- No more than 6 feet long
- Provided to all vibrating equipment, motors, and transformers

8.6. Surface raceway shall be metallic Wiremold.

8.7. Conduits for power and special systems shall be kept separated.

8.7.1. Provide 24 inches of separation where power and special system conduits run parallel.

8.7.2. Provide 12 inches of separation where power and special system conduits cross.

8.8. Buried conduit shall be a minimum of Schedule 40 PVC conduits with elbows and risers provided by PVC-coated rigid galvanized steel.

8.9. Buried conduit shall be a minimum of 36 inches below grade and shall be provided with metallic warning tape 6 to 12 inches below grade routed above the conduit.

8.10. Provide junction boxes for all pull box locations, splices, and taps.

8.11. All conduit penetrations through fire-rated walls shall be sealed as required to maintain the fire rating.

8.12. Mount conduit above accessible ceilings a minimum of 2 feet above the ceiling grid or tight to the structure, whichever is lower.

8.13. Conceal conduit except in unfinished spaces, warehouses, machine shops, and service areas.

8.14. ENT, AC, and MC conduit are not acceptable without written permission.

11040-9. Conductors

9.1. Conductors shall be copper.

9.2. Conductors shall have a 75°C rating, minimum.

9.3. Conductors shall be #12 minimum size for power, #14 for control.

9.4. Conductors shall have a maximum cable size of 500 MCM.

9.4.1. Provide parallel runs where increased amperage is required.

9.5. Wires: #10 and #12 wires may be stranded or solid wires. All other sizes shall be stranded wires.

9.6. Circuits 75 feet long or longer shall be provided with #10 or larger wiring for 120-volt circuits for voltage drop.

9.7. Circuits 150 feet long or longer shall be provided with #10 or larger wiring for 277-volt circuits for voltage drop.

- 9.8. Wire insulation shall be THWN or THHN.
- 9.9. Neutral conductors to computer circuits and variable frequency drives (VFDs) shall be a dedicated #10, minimum.
- 9.10. Romex cable is not permitted.

11040-10. Branch Circuits

- 10.1. Lighting circuits shall be loaded to only 75 percent for future addition.
- 10.2. Do not combine lighting and receptacle power except in elevator pits.

10.3. Motors

- 10.3.1. Motors of 1/2 horsepower or less shall be 120-volt.
- 10.3.2. Motors of 3/4 horsepower or larger shall be 3-phase, 480-volt or 208-volt.
 - 10.3.2.1. Provide phase loss protection for motors of 20 horsepower and larger.
- 10.3.3. The minimum breaker trip setting for motors shall be 15 amps.
- 10.3.4. Provide overload protection for all motors.
- 10.3.5. Match the electrical callouts to the mechanical plan designations.
- 10.3.6. Use NEC tables for minimum conductor current ratings, overcurrent protection sizing, etc.
 - 10.3.6.1. Larger equipment sizes shall be permitted per good practice, but shall not exceed NEC limitations.
 - 10.3.6.2. Manufacturer's recommendations shall govern if equipment requirements are more stringent than the NEC requirements.
 - 10.3.6.3. For packaged mechanical equipment, the manufacturer's recommendations for connection requirements shall govern.
- 10.3.7. Air-cooled chillers shall be provided with a fused disconnect.
- 10.3.8. *VFDs*
 - 10.3.8.1. Locate VFDs within 100 feet of the motor to be served.
 - 10.3.8.2. Follow NEC requirements for minimum conductor current ratings, overcurrent protection sizing, etc.
 - 10.3.8.3. Where VFDs are installed in a location remote from the local disconnecting means, an interlock shall be provided between the disconnect and the VFD so that the VFD will not attempt to power the equipment if the disconnect is in the off position.
 - 10.3.8.4. VFDs shall be provided with bypass to maintain equipment function in the event of the VFD failure.

- 10.4. Show all equipment locations (transformers, panels, motors, etc.) on the drawings.
- 10.5. Provide power to all equipment requiring power as necessary to provide a complete, fully operational system.
- 10.6. Provide power to all mechanical control panels.

11040-11. Receptacles

11.1. Location

- 11.1.1. Locate receptacles where required by code.
- 11.1.2. Locate receptacles where required for specific equipment.
- 11.1.3. Locate receptacles where required by facility operating requirements.
- 11.1.4. Maximum spacing shall be 25 feet on center.
- 11.1.5. Each restroom shall be provided with one GFCI receptacle per each two sinks.
- 11.1.6. Locate one exterior receptacle at each exit and at 100 feet on center around the exterior of the building.
- 11.1.7. Locate one exterior receptacle at each standby/emergency generator.
- 11.1.8. Telecom closets shall be per Chapter 13, "Information Technology," requirements.
- 11.1.9. Locate a receptacle within 25 feet of all exterior mechanical equipment, including air handling units (AHUs), chillers, condensing units, etc.
- 11.2. Recessed, floor-mounted receptacles are not permitted unless deemed necessary and appropriate for the application *and* approved by the BIA.
- 11.3. In kitchen areas, pedestal-type receptacles are required for free-standing equipment.
- 11.4. Receptacles in electrical rooms, mechanical rooms, maintenance areas, or workshops shall be mounted at +48 inches, minimum, and shall be GFCI protected.
- 11.5. Receptacles on opposite sides of the same wall shall be horizontally offset 6 inches regardless of the wall fire rating.

11.6. Specifications

- 11.6.1. Specify a 20-amp receptacle rating, minimum.
- 11.6.2. Use heavy-duty type.
- 11.6.3. Provide nylon fronts and backs.
- 11.6.4. Receptacles located in common areas, such as corridors, gymnasiums, cafeterias, etc., shall be high-abuse type.

- 11.6.5.** Receptacles within 6 feet of a sink, water source, exterior door, or other water source shall be GFCI protected. Feed-through protection is not acceptable.
- 11.6.6.** Exterior receptacles shall be GFCI rated with weatherproof-while-in-use covers.
- 11.6.7.** Kindergarten classrooms, playgrounds, etc., and their auxiliary spaces shall be provided with tamper-resistant, shutter mechanism, safety-type receptacles.
- 11.6.8.** All circuits serving sleeping areas within the dorms shall be provided with arc-fault circuit interrupter protection.
- 11.6.9.** Cover plates shall be 0.040-inch smooth metal, except in the kitchens and restrooms, where cover plates shall be 0.302-inch stainless steel.

11.7. Quantity

- 11.7.1.** Provide for a maximum of four computers per 20-amp circuit.
- 11.7.2.** Provide a maximum of six general-purpose receptacles per circuit.
- 11.7.3.** Dedicated circuits shall be provided for the following:
 - Equipment with a large load
 - Specialty equipment (freezer, refrigerator, public address system, fire alarm, security, elevator equipment, etc.)

11040-12. Switches

- 12.1.** Specify heavy-duty type switches with nylon fronts and backs.
- 12.2.** Switches located in common areas, such as corridors, gymnasiums, cafeteria, etc., shall be keyed switches.

11040-13. Calculations

13.1. Voltage Drop

- 13.1.1.** Provide calculations with enough information to review the method of calculation.
- 13.1.2.** Calculate voltage drop including the full load of panelboards, circuits, and transformers.
- 13.1.3.** Provide voltage-drop calculations for the following:
 - Panelboards more than 100 feet from the point of distribution
 - 120-volt receptacle, lighting, motor, etc., circuits more than 100 feet long
 - 277-volt lighting, motor, etc., circuits more than 200 feet long
 - Maximum drop:

- 2 percent to distribution equipment
- 3 percent from distribution equipment to device

13.2. Short-Circuit Study

13.2.1. During design, the electrical Designer of Record shall provide a short-circuit study based on the available fault current from the utility company, the service transformer impedance, and the selected electrical equipment. The study shall include all portions of the electrical distribution system, from the normal and alternate sources of power throughout the low-voltage (120/208-volt, 3-phase, 4-wire) distribution system. Normal system operating method, alternate operation, and operations that could result in maximum fault conditions shall be thoroughly covered in the study.

13.2.2. After award of the contract, the contractor shall provide a short-circuit study based on the actual equipment to be provided and shall meet the requirements stated above. The short-circuit study shall be completed within four months after the award of the electrical contract.

13.3. Coordination Study

13.3.1. During design, the electrical Designer of Record shall provide a coordination study based on the selected electrical equipment. The study shall be provided to check the selections of breaker-trip characteristics and settings in relation to upstream and downstream circuit breaker characteristics and settings. The study shall include all voltage classes of equipment, from the utility primary over current protection to the MDP and down to and including each MCC and/or panelboard and the phase and ground overcurrent protection.

13.3.2. After award of contract, the contractor shall provide a coordination study based on the actual equipment to be provided and shall meet the requirements stated above. The coordination study shall be completed within four months after the award of the electrical contract.

13.3.3. The contractor or testing firm shall set all circuit breakers in accordance with the coordination study after the settings have been reviewed by the engineer. The contractor shall test the accuracy of these settings and the functionality of the circuit breakers.

11040-14. Kitchen Requirements

14.1. Coordinate equipment power shutdown requirements for the fire protection system as needed to meet code requirements.

11040-15. Hazardous Locations

15.1. Receptacles located in workroom and vehicle maintenance areas shall be mounted 4 feet above finished floor (AFF).

11040-16. Cathodic Protection

16.1. Where the soil resistivity is 10,000 ohm-cm or less, a magnesium sacrificial anode or impressed current cathodic protection system shall be provided for the following:

- Metal water tanks, interior and exterior
- Underground metal piping, including water, gas, fuel, and fire suppression
- Metal lift stations
- Treatment plant components in contact with earth or water
- Structural components such as rebar, etc.
- Any metals located in soil or water

16.2. Design of cathodic protection shall be performed by an engineer licensed in corrosion engineering or a specialist certified by NACE International. The designer shall have a minimum of five years' experience in similar installations.

16.2.1. In addition to providing the design, the specialist shall be required to supervise the installation and testing of the cathodic protection system for compliance with the developed requirements.

16.3. Resistivity data shall be obtained from the soils or foundation report and provided to the cathodic system designer.

16.4. Conduct current requirements test as required.

16.5. Construction drawings and specifications shall be provided as required to show the extent of the facilities to be protected, the type of equipment required, location of installation for the equipment, location of test points, and details as required to provide a complete system. These documents shall include the complete design as required for the purchase and installation of a fully operational system.

16.6. Provide sufficient corrosion control test stations as required to provide proper monitoring of the system.

16.7. The cathodic protection system shall be designed to provide a minimum of 25 years of continuous protection.

11040-17. Equipment Labeling

17.1. Switchboards, panelboards, disconnect switches, transformers, starters, and other special distribution equipment shall be provided with the following:

17.1.1. Engraved plastic labels:

- White letters on black background.
- Minimum text height of 1/4 inch.

- Attach the label with screws or rivets. Pressure adhesives are not acceptable.

17.1.2. Identification to be provided on engraved labels:

- Indicate equipment name as shown on the electrical drawings.
- Indicate voltage.
- Indicate single or 3-phase.
- Indicate amperage.
- Indicate AIC rating.
- Indicate where the equipment is fed from.

17.1.3. Provide labeling for arc flash warning requirements.

17.1.4. Mount the label on the front of equipment. Labels shall *not* be located behind doors or covers.

17.2. Typed panel schedules shall be provided for record within each panelboard and shall indicate all of the equipment called out on the panelboard label as well as the individual circuiting information.

17.3. Provide an as-built copy of the one-line diagram mounted on the wall of the main electrical room.

17.4. Junction boxes shall be labeled on the front cover with the contents of the box. The labeling shall be made with permanent ink and shall include the panelboard name and circuit numbers.

17.5. All cover plates, junction boxes, load centers, panelboards, safety switches, etc., associated with *emergency* power shall be painted red. Standby power shall be labeled similar to normal power.

17.6. All fire alarm system junction boxes, raceways, switches, etc., shall be red.

17.7. Cover plates: All receptacles and toggle switches shall indicate the panelboard and circuit number of the device on the front of the cover plate.

17.7.1. Clearly label all devices and assemblies with adhesive identification tape, giving panel identification and branch circuit number.

17.7.2. Exterior device and assembly locations shall utilize nonadhesive aluminum tape labels fastened to the device.

17.7.3. Text shall be black on clear tape, where possible, with a minimum text height of 3/32 inch.

11040-18. Housekeeping Pads

18.1. Housekeeping pads shall be provided for all major floor-mounted equipment such as MDPs, switchgear, transformers, generators, etc.

- 18.2. Pads shall be of 3½- to 4-inch-thick reinforced concrete and shall extend a minimum of 4 inches in each direction beyond the equipment to be supported.
- 18.3. Provide conduit windows in the housekeeping pad as appropriate to the equipment to be supported.

11040-19. Fuse Cabinet

- 19.1. Provide a fuse cabinet within the main electrical room to store spare fuses.
- 19.2. Provide three spare fuses for each fuse size installed and store them in the fuse cabinet. Size the fuse cabinet as required to hold all required fuses noted.

11050-1. General

- 1.1. Provide a complete grounding system for all distribution and branch systems.

11050-2. Main Distribution Panel Grounding

- 2.1. Connect the main distribution panel (MDP) to a ground bar located in the main electrical room or MDP.
- 2.2. The system bonding jumper shall be provided at the MDP or service entrance panel and *not* at the transformer.
- 2.3. Bond the main electrical room ground bar to the following, at a minimum:
 - 2.3.1. Structural steel.
 - 2.3.2. Cold water piping.
 - 2.3.3. Concrete foundation reinforcing (where available).
 - 2.3.4. Ground rod(s).
 - 2.3.4.1. Ground rods shall consist of a 3/4-inch by 10-foot-0-inch copper-clad steel rod.
 - 2.3.4.2. Drive ground rods until tops are 2 inches below finished floor or final grade, unless otherwise indicated.
 - 2.3.4.3. Inspection wells for ground rods shall be nonmetallic with a nonmetallic cover, minimum thickness 1/2 inch, with a bolt to hold the cover in place.
 - 2.3.4.4. Connections to ground rods shall be made with exothermic welds where not in inspection wells.
 - 2.3.4.5. Ground the steel framework of the building with a driven ground rod at the base of every corner column and at intermediate exterior columns at distances of not more than 60 feet. Provide a grounding conductor (counterpoise), electrically connected to each ground rod and to each steel column, extending around the perimeter of the building. Use tinned-copper conductor not less than number 4/0 AWG for the counterpoise and for the tap to building steel. Bury the counterpoise not less than 36 inches below grade and 24 inches from the building foundation.
 - 2.3.4.6. Bond the counterpoise to the main electrical room ground bar with two number 4/0 cables in conduit.
 - 2.3.5. Each above-ground portion of the gas piping system upstream from the equipment shutoff valve.
 - 2.3.6. Lightning protection system:
 - 2.3.6.1. Bond the MDP ground to the lightning protection system grounding conductor at the closest point to the electrical service grounding

electrode. Use a bonding conductor sized the same as the system grounding electrode conductor and install in conduit.

2.3.6.2. Refer to Section 11120, "Lightning Protection," for additional information.

2.3.7. Telecommunications room ground bar(s) with number 4 wire, minimum.

2.4. Maximum interconnected ground resistance shall be 5 ohms.

2.4.1. Reports indicating actual ground resistance shall be provided to the BIA for review during construction.

2.4.2. In areas of high ground resistance, provide recommendations to the BIA on methods to achieve the recommended ground resistance.

2.5. Building-steel and underground connections shall be made with exothermic welds.

2.6. Chemical electrodes shall be permitted only when approved by the BIA *in writing*.

11050-3. Grounded Equipment

3.1. Provide an equipment ground wire in all raceways.

3.1.1. Bond to all ground lugs, busses, switches, receptacles, equipment frames, etc.

3.1.2. Provide a bonding jumper from the grounding screw of all receptacles to a metallic box that is mounted with a separate grounding screw or clip device.

11050-4. Exterior Metal Poles

4.1. Exterior metal poles, such as light poles, flagpoles, banners, etc., shall be provided with an equipment ground wire *and* ground rod at each pole location.

11050-5. Mechanical Equipment

5.1. Bond interior metal piping systems and metal air ducts to equipment grounding conductors of associated pumps, fans, blowers, electric heaters, and air cleaners. Where metallic piping and duct systems are rendered metallically noncontinuous by nonconductive couplings, provide bonding jumpers to restore grounding continuity.

11060-1. General

- 1.1. The interior lighting system shall be designed to provide light levels suitable for the intended use of the individual spaces.

11060-2. Energy Performance

- 2.1. All lighting systems shall be designed to meet or exceed the current ASHRAE 90.1 energy code requirements.
- 2.2. The lighting systems shall be designed in coordination with the daylighting design for maximum energy savings.
- 2.3. The lighting Designer of Record shall report the preliminary lighting power densities in the design analysis report and the final lighting densities to the energy modeler during the design process to determine compliance and make adjustments as necessary.

11060-3. Emergency Lighting

- 3.1. Emergency egress lighting shall be provided in the following areas:

- Emergency egress paths and exits
- Exterior of all exit doors
- Instructional areas without daylight
- Assembly areas and rooms with an occupant load over 50
- Locker rooms
- Kitchens
- Multi-stall restrooms
- Conference rooms
- Main electrical room
- Emergency power equipment location
- Administration areas with building control panels

- 3.2. Where available, provide generator power for life safety lighting.

- 3.2.1. If a generator is not provided, the acceptable methods for supplying emergency power to the lighting fixtures shall be considered in the following order:

- Integral battery ballast in select fixtures
- Stand-alone battery fixtures (wall packs)
- Central inverter system

11060-4. Exit Signs

- 4.1. LED exit signs shall be used.
- 4.2. Exit signage shall be provided in the following areas:
 - Emergency egress paths and exits
 - Interior of all exit doors
 - Assembly areas and rooms with an occupant load over 50
 - All spaces with two or more doors (even if the not all doors are in the path of egress)
- 4.3. Where exit signage is required, an additional sign shall be provided at 12 inches above the finished floor measured to the bottom of the sign.
- 4.4. Within accessible spaces or accessible building portions requiring exit signs, where all available means of egress are not accessible, the International Symbol of Accessibility shall be incorporated on exit light units to distinguish the accessible means of egress.

11060-5. Lamps

- 5.1. The lighting for each facility should be designed to minimize the number of lamp types on the project.
- 5.2. Fluorescent, 4-foot T8 lamps shall be used in as many luminaires as possible.
- 5.3. Fluorescent, 4-foot T5 and T5HO lamps may be used in high-ceiling applications such as gymnasiums and commons areas. These lamps may also be used where more precise lighting distributions are required, such as in cove lighting or for wall washing.
- 5.4. There should be no more than three interior lamp types for a given project. There shall be no more than three lamp types used in theatrical lighting luminaires.
- 5.5. Due to the shorter lamp life and higher lamp cost, compact fluorescent lamps shall only be used in areas where a linear 4-foot luminaire will not fit or where there are unique design considerations.
- 5.6. All fluorescent lamps shall be 4100K color temperature with a color rendering index (CRI) of 85 or higher.
- 5.7. Provide low-dose mercury lamps for all lamp types that are available in a low-dose mercury version. Low-dose mercury shall be defined as any lamp that passes the Environmental Protection Agency's Toxicity Characteristic Leaching Procedure (TCLP) test for lamps.
- 5.8. Incandescent lamps may be used in the following areas only:
 - House lighting for dimmed auditorium spaces
 - Track lighting in auditorium control booths

- Mirror lighting for theatrical dressing rooms
 - Track lighting in art room areas for instructional purposes
- 5.9.** The minimum lamp life allowed for all incandescent lamps shall be 2,000 hours. All incandescent fixtures shall be on dimmed circuits to extend lamp life.
- 5.10.** High-intensity discharge lamps shall not be used for interior lighting.
- 5.11.** Light emitting diodes (LEDs): To reduce maintenance and energy costs, the use of LED light sources is strongly encouraged. Examples of LED light source applications could include steplights in auditoriums and exterior spaces, downlights, and cove lighting. As LED light output improves, other applications may be acceptable.

11060-6. Ballasts

- 6.1.** Linear fluorescent lamp ballasts shall have the following characteristics:
- 6.1.1.** Ballasts shall be electronic with a minimum 5-year warranty.
 - 6.1.2.** The manufacturer shall have a minimum 10-year history of making ballasts for the North American market.
 - 6.1.3.** Ballasts shall not contain polychlorinated biphenyls (PCBs).
 - 6.1.4.** Instant-start ballasts shall be used unless the fluorescent lighting systems are anticipated to have more than five starts per day. If the lighting systems will have more than five starts per day, programmed-start ballasts shall be used (reference NEMA LSD 18 Compatibility of Fluorescent Lamps and Electronic Ballasts in Frequent Switching Applications). Only one type of linear fluorescent ballast (instant start or programmed start) shall be used for the entire project.
 - 6.1.5.** Rapid-start ballasts shall be used with occupancy sensors (one type shall be used on the entire project).
 - 6.1.6.** Total harmonic current distortion shall be less than 10 percent.
 - 6.1.7.** The power factor shall be greater than 0.98.
 - 6.1.8.** The ballast factor shall be 0.88.
 - 6.1.9.** The audible noise rating shall be Class A or better.
 - 6.1.10.** The ballast shall support a sustained short-to-ground or open circuit of any of the output leads without damage to the ballast.
 - 6.1.11.** The ballast shall have a lamp current crest factor of less than 1.7.

11060-7. Lighting Level Requirements

Figure 11060-1: Lighting Level and System Type Requirements by Room Type

Building Area	Luminaire Type	Lighting Level Average Maintained Horizontal Foot- Candles 30 Inches Above Floor
Classrooms and library with daylighting	Suspended linear direct/indirect fluorescent with multi-level switching	35–40
Classrooms without daylighting	Suspended linear direct/indirect fluorescent with multi-level switching	45–50
Computer classrooms	Suspended linear direct/indirect fluorescent with multi-level switching	30–35
Administration areas, teacher workrooms, conference rooms	Fluorescent with multi-level switching	45–50
Cafeteria	Fluorescent with multi-level switching	30–35
Lobbies and corridors	Fluorescent	15–20
Locker rooms	Fluorescent	20–25
Gymnasium	Fluorescent with T8 or T5HO lamps and multi-level switching	35–45
Kitchen	Fluorescent with enclosed and gasketed lenses	45–50
Wood and metal shop areas	Fluorescent with enclosed and gasketed lenses	45–50
Restrooms	Fluorescent	30 at vanity, 15 other areas
Auditorium	Dimmed incandescent or fluorescent, LED steplights	15–20
Storage and utility rooms	Fluorescent with wraparound acrylic lenses	15–20

11060-8. Ceiling Fire Rating

- 8.1. Where a fire-rated ceiling is provided, the lighting system shall be designed as required to maintain the rating.

11060-9. Luminaire Mounting

- 9.1. All light fixtures shall be mounted in a secure and stable manner.
- 9.2. Seismic restraint requirements shall be coordinated with the individual site. Local seismic codes shall be considered the minimum requirements.

11070-1. General

- 1.1. Exterior lighting shall be designed to minimize light pollution and light trespass. Refer to the current LEED guidelines for specific information about requirements to qualify for the Light Pollution Reduction credit.

11070-2. Lamps

- 2.1. Exterior wall- or canopy-mounted lights shall be triple-tube compact fluorescent for emergency egress lighting.
- 2.2. Metal halide lamps shall be used for all other exterior lighting.

11070-3. Ballasts

- 3.1. Compact fluorescent light fixtures shall utilize electronic ballasts with a 5-year warranty and 0°F starting temperature.
- 3.2. Metal halide ballasts shall be constant-wattage type, with a minimum starting temperature of minus 40°C and with a noise rating of B or better.

11070-4. Poles

- 4.1. Refer to Section 11050 for grounding requirements.
- 4.2. Light poles shall be galvanized steel or steel with a corrosion-resistant powder coat painted finish.
- 4.3. For most projects, all light poles and other support structures (brackets, arms, appurtenances, bases, and anchorage and foundations) shall comply with the American Association of State Highway and Transportation Officials (AASHTO) 1994 *Specifications for Structural Supports for Highway Signs, Luminaires, and Traffic Signals*, with current interims. For project sites where unusually high winds or persistent wind conditions exist, use the AASHTO 2001 standards with current interims.
- 4.4. Light poles shall have a wind-load strength adequate at indicated heights above grade without failure, permanent deflection, or whipping in steady winds of the speed for the project site with a gust factor of 1.3.
- 4.5. Pole supports shall be reinforced concrete.
- 4.6. Locate poles to minimize potential damage from vehicles and snow removal. Poles shall be located on a landscaped island or at perimeters of parking areas wherever possible. Provide an elevated concrete foundation 24 inches above grade where poles are located in paved parking areas.

11070-5. Lighting Level Requirements

Figure 11070-1: Lighting Level and System Type Requirements by Exterior Area

Exterior Building Area	Luminaire Type	Lighting Level Average Maintained Horizontal Foot- Candles at Ground, Max:Min Ratio
Building entries	Wall-mounted or canopy-mounted compact fluorescent with full cutoff optics	5.0–8.0 10:1
Parking areas	Pole-mounted metal halide with full cutoff optics	1.0–1.5 10:1
Pedestrian path from parking to building(s)	Pole-mounted metal halide with full cutoff optics	0.5 10:1
Access roads	Pole-mounted metal halide with full cutoff optics	0.5
Baseball/softball field	Pole-mounted metal halide	50 infield, 2:1 30 outfield, 2.5:1
Football field	Pole-mounted metal halide	30–35 2.5:1
Soccer field	Pole-mounted metal halide	30 2.0:1

11070-6. Calculation Requirements

- 6.1. Provide point-by-point computer calculations for all exterior lighting, including lighting at building entrances. Point-by-point analysis shall consist of maintained horizontal illuminance at the ground with a maximum grid spacing of 10 feet by 10 feet for parking areas and 5 feet by 5 feet for entry areas.
- 6.2. Provide point-by-point computer calculations for all exterior sports lighting systems. Point-by-point analysis for these systems shall be provided as part of a performance specification from the system manufacturer. The engineer shall obtain calculations during design to ensure that the systems meet specifications prior to engineering the complete system.

11070-7. Exterior Lighting Control – ASHRAE 90.1 Requirements

- 7.1. Exterior lighting shall be controlled via a photocell and time clock combination. Non-security lighting shall be turned off after normal operating hours via a building automation system time clock or via an electromechanical time clock in cases where a building automation system is unavailable.

11080-1. General

- 1.1. Projects that have a direct digital control (DDC) system shall use the building automation time clock for after-hours automatic control of the lighting systems. Photocell controls shall be used for site lighting and daylight harvesting of interior lighting.

11080-2. ASHRAE 90.1 Requirements

- 2.1. All lighting control systems shall conform to ASHRAE 90.1 requirements. These requirements include automatic means for turning off lighting after normal operating hours. Building automation system time clocks and/or wall switch-type occupancy sensors may be used.

11080-3. Occupancy Sensors

- 3.1. Occupancy sensors shall be used in the following types of spaces with the technology type and mounting indicated:

Figure 11080-1: Occupancy Sensor Requirements

Room Type	Sensor Type	Mounting
Small storage rooms	Infrared	Wall switch type
Conference rooms Work rooms Classrooms Large storage rooms	Infrared	Wall mounted if pendant lighting is used Ceiling mounted if recessed lighting is used
Restrooms	Ultrasonic	Ceiling mounted

- 3.2. Specify sensors with appropriate coverage patterns for each space. Locate sensors to avoid false “on” tripping due to open doorways or vibrations created by other building systems. Set all sensor time delays to 30 minutes.

11080-4. Time Clocks

- 4.1. Individual time clocks may be used if the building does not have a building automation system. These time clocks shall have the following functions:
- Electromechanical-dial type complying with UL 917
 - Astronomic dial
 - 20-amp contact rating
 - Manual hand-off-auto switch
 - Timing motor – heavy-duty synchronous, 16-hour reserve power

11080-5. Lighting Contactors

- 5.1.** Lighting contactors shall be used if they are controlled via the building automation system or with an electromechanical time clock.

11090-1. General

- 1.1. In the course of any building project, additional requirements for power and conduits arise based on the needs of other disciplines and specialty equipment. In assessing power requirements, be sure that coordination between all other disciplines has occurred, all equipment is taken into consideration, and that all necessary power and conduit connections are provided.
- 1.2. Some commonly missed coordination items are listed below. This list is not intended to be complete nor is it intended to be in lieu of project-specific coordination.

11090-2. Conduit

- 2.1.1. Refer to Section 11040 for additional information.

11090-3. Communications

- 3.1. Provide dedicated power to sound systems, such as:
 - 3.1.1. Campus public address/bell system.
 - 3.1.2. Gymnasium and auditorium sound systems. The gymnasium and auditorium sound systems shall be interlocked with the fire alarm system to shut down the local sound system upon fire alarm activation.
 - 3.1.3. Telephone/intercom system.
 - 3.1.4. Clock system.

11090-4. Security

- 4.1. Provide power to the following items where applicable:
 - Burglar alarm panel via a dedicated circuit
 - Electric door strike and/or associated power packs
 - Magnetic door locks and/or associated power packs
 - Security cameras requiring power
 - Security monitoring equipment, i.e., video monitors, recording equipment, etc., via a dedicated circuit
 - Repeaters
- 4.2. Coordinate interface between security requirements and door release functions for the fire alarm system.

11090-5. Architectural Equipment

- 5.1. Coordinate power and/or lighting requirements to site signage.
- 5.2. Coordinate motorized bleacher power requirements.
- 5.3. Coordinate motorized door locations and requirements.

- 5.4. Coordinate automatic and power-assisted doors and gates to meet ADAABAAG requirements.
- 5.5. Coordinate electric water cooler locations and requirements.
- 5.6. Coordinate ceiling-mounted projector locations and requirements.
- 5.7. Verify special power requirements for video conferencing.
- 5.8. Coordinate motorized screen requirements.
- 5.9. Coordinate power and locations for scoreboards in gymnasiums and at ball fields.

11090-6. Irrigation

- 6.1. Provide a power connection to the irrigation controller.
- 6.2. Provide power to the irrigation fertilizer pump system.
- 6.3. Provide a convenience receptacle at the grounds maintenance shed.

11090-7. Theatrical Equipment

- 7.1. Coordinate any theatrical lighting, sound system, intercom, microphone, special equipment, etc., where applicable.

11090-8. Miscellaneous

- 8.1. Coordinate power requirements for any miscellaneous facility equipment such as radio towers, guard shacks, etc.

11100-1. General

- 1.1. Fire alarm systems and installation shall comply with NFPA 5000, NFPA 72, and ADAABAAG requirements for the number and placement of devices.
- 1.2. Refer to Section 11020, “Codes, Standards, and Laws,” for additional code compliance requirements for fire alarm systems.
- 1.3. The fire alarm system shall be provided with Class A wiring, 14 gauge, minimum.
- 1.4. The specifications for the fire alarm system shall be performance based. It shall be the responsibility of the engineer who develops the shop drawings to provide a code-compliant design and installation.
- 1.5. Device locations shall be indicated on the construction plans *and* shop drawings.
- 1.6. Submittals shall include the following:
 - 1.6.1. Shop drawings shall be signed and stamped by a registered professional engineer or fire protection engineer for the state in which the project is to be constructed.
 - 1.6.2. Battery calculations.
 - 1.6.3. Voltage drop calculations.
 - 1.6.4. Catalog data sheets.
 - 1.6.5. Floor plans with actual device locations, device addresses, and routings of raceway connections.
 - 1.6.6. A detailed description for the project, including method of operation and supervision for each type of circuit and sequence of operations for manually and automatically initiated system inputs and outputs. Manufacturers’ standard descriptions for generic systems are not acceptable.
 - 1.6.7. A complete list of device addresses and corresponding messages.
 - 1.6.8. A detailed wiring diagram differentiating between manufacturer-installed and field-installed wiring. Include diagrams for equipment and for systems that are supervised or controlled by the fire alarm control panel (FACP), with all terminals and interconnections identified. Diagrams shall show all connections from field devices to the FACP and remote fire alarm control units, initiating circuits, switches, relays, and terminals. Provide point-to-point wiring diagrams showing all internal panel wiring connections and jumper positions.
 - 1.6.9. A full-size drawing of the graphic map at actual production scale.
- 1.7. Provide at least 25 percent spare capacity for notification appliances and 25 percent spare capacity for initiating devices.

- 1.8. The fire alarm system shall be a separate, stand-alone system and shall *not* be based on the telecommunication system or servers.

11100-2. Where Required

- 2.1. Provide a fire alarm system for all institutional buildings.
 - 2.1.1. This includes schools, dormitories, kitchen/dining halls, etc.
 - 2.1.2. Excluded buildings shall include dwellings, storage buildings (not including hazardous storage), and well buildings unless a fire alarm system is specifically required by code or requested by the Contracting Officer.
 - 2.1.3. Each building shall have a separate, stand-alone fire alarm system where required.

11100-3. Fire Alarm Control Panel

- 3.1. The FACP shall be a noncoded, addressable-analog system with manual and automatic alarm initiation and multiplexed signal transmission dedicated to fire alarm service only. All automatic and manual initiating devices shall be the addressable type.
 - 3.1.1. Zoned systems are not acceptable.
 - 3.1.2. The FACP shall display a minimum of 80 characters; alarm, supervisory, and component status messages; and shall indicate control commands to be entered into the system for control of smoke detector sensitivity and other parameters. A backlit display shall be provided upon failure of the normal power source.
 - 3.1.3. A keypad shall be provided to permit entry and execution of programming, display, and control commands.
 - 3.1.4. The FACP shall control elevator recall/shunting, door hold-opens, dampers, fan shutdown, smoke control, etc., as necessary to accommodate the requirements for the specific site.
 - 3.1.5. A “trouble reminder” feature shall be included with an adjustable time setting.
- 3.2. Power to the FACP shall be provided via a dedicated circuit with a key-lockable breaker.
- 3.3. The FACP shall be provided with battery backup power capable of sustaining 24 hours of system monitoring followed by 5 minutes of alarm conditions with 10 percent spare capacity.
 - 3.3.1. The battery shall be a nickel-cadmium type with charger and an automatic transfer switch.
 - 3.3.2. Battery nominal life expectancy shall be 20 years, minimum.

- 3.4. When available, the FACP shall be backed up by the emergency or standby generator *and* the battery system.
- 3.5. The FACP shall be provided with an automatic telephone dialer, radio transmitter, digital communicator, or other approved means as specified by the BIA, to notify a remote monitoring station, the local fire station, or an independent monitoring facility.
 - 3.5.1. The remote monitoring entity shall be determined during the Schematic Design phase of the project.
- 3.6. The FACP shall be located in the administrative area or as designated by the BIA.
- 3.7. The FACP shall be capable of accommodating on-site minor additions or deletions to the system with no additional hardware or software required.
- 3.8. Software in the FACP shall be stored in a nonvolatile memory configuration such that programming information is *not* lost upon loss of power.
- 3.9. The FACP shall incorporate flexible input/output control functions based on AND, OR, NOT, timing, and special code operations.
- 3.10. The FACP shall be able to recall alarms and trouble conditions in chronological order to recreate an event history. A minimum of 50 event recordings shall be required.
- 3.11. A separate designation shall be provided for each HVAC unit associated with the fire alarm system.
- 3.12. An annunciator shall be provided at each main entry and where otherwise required by code. The annunciator shall duplicate functions of the FACP for alarm, supervisory, and trouble indications, and shall provide manual switching functions of the FACP, including acknowledging, silencing, reset, and test.
- 3.13. A nonilluminated graphic map shall be provided at the FACP and each annunciator location.
- 3.14. Where required, provide voice annunciation, fire phones, radio booster, smoke control, emergency messaging, fire pump monitoring, pre-action systems, agent release systems, alarm verification, or other special fire alarm requirements as coordinated with the project-specific requirements and code compliance.

11100-4. Manual Pull Stations

- 4.1. Provide double-action equipment with an indoor protective shield hinged at the top to permit lifting for access to initiate an alarm.
- 4.2. Lifting the shield shall actuate an integral battery-powered 85-decibel horn intended to discourage false alarm operation.
- 4.3. Locate pull stations per code requirements, but not less than at every exit, every 200 feet, and on every level, except as specifically noted otherwise.

- 4.4. Provide an additional pull station at each exit from a kitchen or break room.

11100-5. Detection

- 5.1. Provide detection for select areas only as required to meet code requirements.

- 5.1.1. Provide detection at the FACP, in elevator lobbies, in elevator shafts, in elevator machine rooms, at doors between areas of separation, for smoke-activated fire alarm functions, etc., as necessary to meet code requirements.

- 5.1.2. Provide detection below raised floors. Detectors shall be rated for the air velocities present.

5.2. Duct Detectors

- 5.2.1. Provide duct detectors in supply *and* return ducts for air handling units (AHUs) with air velocities of 2,000 cubic feet per minute or greater.

- 5.2.2. Ensure that duct detectors are located prior to any duct splits, or provide a duct detector on each branch of duct work where required for complete coverage.

- 5.2.3. Remote indicating lights and keyed test switches shall be provided for each duct detector.

- 5.2.3.1. Locate the detector in the nearest corridor or other common space, wall mounted at 7 feet 0 inches above finished floor (AFF). Provide a permanent label indicating which unit the duct detector is protecting.

- 5.2.3.2. When a duct detector is concealed above a ceiling, provide a permanent label on the access door or the ceiling tile used for service access to the duct detector, indicating which duct detector is at that location.

- 5.2.4. Provide a detector within 5 feet of each fire/smoke damper.

- 5.2.5. Activation of a duct detector shall shut down the associated AHU.

- 5.2.6. Manual override shall be provided for testing of AHU shutdown upon duct detector activation.

5.3. Smoke and Heat Detectors

- 5.3.1. Where detection is required:

- 5.3.1.1. Locate detectors at least 5 feet from supply air grilles.

- 5.3.1.2. Locate detectors at least 12 inches from lights.

- 5.3.1.3. Consider stratification effects when selecting detector locations.

- 5.3.1.4. Where required by paragraph 5.1 above, heat detectors shall be provided for any kitchen, boiler room, main electrical room, kiln

room, or other location where dirt or debris are likely to cause false alarms.

5.3.1.5. Heat detectors shall be intermediate fixed temperature rated.

11100-6. Notification

6.1. Horns/Speakers

- 6.1.1. Provide a sufficient number of horns/speakers spaced as required to achieve 15 decibels above ambient sound levels and 5 decibels above the maximum sound level.
- 6.1.2. Provide horns/speakers as required by code and in each corridor, cafeteria, classroom, vocal room, instrumental room, mechanical room, break room, soundproof room, and dormitory sleeping room.
- 6.1.3. Provide gymnasiums and auditoriums with either live or pre-recorded voice announcements and visible devices.
- 6.1.4. Where a gymnasium, auditorium, cafeteria, etc., has a local sound system, provide the means to disengage the sound system upon activation of the fire alarm system and initiate a pre-recorded voice announcement. Provide a local override to allow for live announcements. The override shall time out and resume the pre-recorded message within 10 seconds after the end of the live message.

6.2. Strobes

- 6.2.1. The candela level provided by the strobes shall be coordinated with the application and location as required to meet code requirements.
 - 6.2.2. Provide strobes as required by code and in each corridor, cafeteria, classroom, vocal room, instrumental room, mechanical room, break room, soundproof room, dormitory sleeping room, conference room, training room, restroom, etc.
- 6.3. Provide separate circuits to the horns and strobes to enable separate horn/speaker silence features.
 - 6.4. Provide audible/visual notification within 15 feet of all exits.
 - 6.5. Provide an exterior weatherproof horn/strobe at the fire department Siamese connection or at the point of entry of the fire department where a Siamese connection is not installed.
 - 6.6. Provide two-way communication between areas of refuge and the FACP.

11100-7. Monitored Equipment

7.1. As a minimum, the following additional equipment shall be monitored by the FACP. Activation of the monitored equipment shall create an alarm or trouble condition as required by code.

- The kitchen hood fire protection system
- Main building and elevator dedicated flow and tamper switches

11100-8. Elevator Recall/Shunt

8.1. Provide an integral relay capable of sending a direct signal to initiate a control device, for instance to an elevator controller to initiate elevator recall, or to a circuit-breaker shunt trip for power shutdown.

11100-9. Magnetic Door Hold-Opens

- 9.1.** Configure door hold-opens to close upon any alarm.
- 9.2.** Coordinate voltage requirements for magnetic door hold-opens.
- 9.3.** Coordinate door hold-opens with security requirements.

11100-10. Riser Diagram

10.1. Riser diagrams for the fire alarm system shall indicate the following as a minimum:

- FACP
- Annunciator(s)
- Separate circuits to horns and strobes
- The automatic dialer, digital communicator, or radio transmitter
- HVAC equipment requiring shutdown
- Smoke and heat detectors
- Manual pull stations
- Duct detectors and the associated remote indicating lights and test switches
- Flow and tamper switches
- Kitchen hood fire suppression equipment
- Risers and loops
- Voice communication (where necessary)
- Power source
- Door hold-opens
- Other equipment necessary for a complete installation

- 10.2.** Riser diagrams shall indicate the room numbers associated with the panels and devices on the diagram.

11100-11. Protection

- 11.1.** Provide wireguards with 0.125-inch wire, minimum, for fire alarm equipment located in main gymnasiums, auxiliary gymnasiums, locker rooms, and other areas where damage to the equipment is likely.
- 11.2.** All devices to be installed shall be tamper-resistant, where possible.

11100-12. Special Requirements

- 12.1.** Where directed by the BIA, provide special equipment as required by the NFPA for the visually and hearing impaired.

THIS PAGE INTENTIONALLY LEFT BLANK

11110-1. General

- 1.1. To meet life safety requirements, some type of emergency power is required for all BIA school facilities. The means by which the emergency power is obtained will vary from one location to another.
- 1.2. Coordinate emergency power requirements for each location with the BIA.

11110-2. Required Generator Power

- 2.1. A standby generator shall be provided where utility reliability is low or loss of power for extended periods would cause hardship to the students or faculty.
- 2.2. Schools that are to be used as recovery facilities after natural disasters shall be provided with standby generators. Coordinate with the BIA to determine if the new building is to serve this purpose, and if so, what area(s) of the building will be used.
- 2.3. The electrical Designer of Record shall perform an analysis of the utility service as noted in this section and in Section 11030, "Exterior Utilities," and shall provide a recommendation to the BIA as to whether or not a generator shall be included in the project and what equipment should be connected to it.
- 2.4. The BIA will review the analysis and recommendations and approve or disapprove the inclusion of a generator.

11110-3. Generator Sizing

- 3.1. When required, the generator shall be sized to support the following loads:
 - Life safety lighting.
 - Convenience lighting in the main office, cafeteria, electrical room, and main telecom room.
 - Elevator(s).
 - Alarm system(s).
 - Public address system.
 - Intercom system.
 - Telephone system.
 - Freezers and refrigerators.
 - Food preparation power.
 - Boiler(s).
 - Water circulating pump(s).
 - Fire pump. Verify that the starting voltage drop is within the fire pump parameters.
 - Sewage pump(s).
 - Dormitory rooms.

11110-4. Generator Installation

- 4.1. Generators shall be installed outdoors wherever possible.
- 4.2. Indoor installations require special provisions, such as combustion air, exhaust, ventilation, and a 2-hour fire-rated room with a minimum of 3 feet clearance around the generator. Coordinate requirements with the BIA prior to selecting an indoor installation.

11110-5. Generator Connection Point

- 5.1. Where budget and other factors prohibit the installation of a standby generator, consideration shall be given to providing a “plug-in” location for a portable generator, such as a manual transfer switch located in an easily accessible location.

11110-6. Generator Requirements**6.1. Fuel Source**

- 6.1.1. Natural gas is the preferred fuel source for generators below 100kW in size. Verify with the gas utility that the gas supply is classified as an “uninterruptible” service. If not, a second fuel source is required.
- 6.1.2. The first choice for an alternate fuel source is diesel, followed by propane.
- 6.1.3. Coordinate the fuel source with the BIA prior to final selection.
- 6.2. The required regular generator testing shall be performed under actual load conditions. A load bank shall not be provided.
- 6.3. Parallel generators shall not be permitted.
- 6.4. The muffler shall be critical grade.

11110-7. Automatic Transfer Switch

- 7.1. Provide a separate automatic transfer switch (ATS) to emergency and standby power distribution.
- 7.2. The ATS shall have an adjustable exercise clock adjustable from 7 to 30 days, with running periods adjustable from 10 to 30 minutes.
- 7.3. The time delay for retransfer to normal power shall be adjustable from 0 to 30 minutes and factory set for 10 minutes. Provide automatic defeat of delay on loss of voltage or sustained undervoltage of emergency power, provided the normal power supply has been restored.

11110-8. Remote Annunciator

- 8.1. Provide a remote annunciator indicating generator status located in the administration area or other location requested by the BIA.
- 8.2. The annunciator shall be provided with an emergency generator shutdown button.

11110-9. Warranty

9.1. The generator shall be provided with a 5-year warranty, minimum.

11110-10. Uninterruptible Power Supply

10.1. One or more rack-mounted uninterruptible power supply (UPS) units shall be provided in every telecommunications room.

THIS PAGE INTENTIONALLY LEFT BLANK

11120-1. General

- 1.1. Perform an NFPA 780 risk assessment for the building site to evaluate the need for a lightning protection system.
 - 1.1.1. The risk assessment shall include the frequency of lightning in the area, the height of the building(s), surrounding buildings and terrain, the sensitivity of the equipment within the building, etc.
- 1.2. Provide a recommendation to the BIA as to whether or not a lightning protection system is required.
- 1.3. The BIA will review the analysis and recommendations and approve or disapprove the inclusion of a lightning protection system.
- 1.4. Refer to Section 11000 for additional information.

11120-2. Installation

- 2.1. The lightning protection system shall be installed as unobtrusively as possible.
- 2.2. Build in or hide conductors within the building structure wherever possible.
- 2.3. Provide proper flashing for a watertight seal for all roof penetrations.
- 2.4. Conceal the following conductors:
 - System conductors
 - Down-lead conductors
 - Interior conductors
 - Conductors within normal view from exterior locations at grade within 200 feet (60 meters) of the building
- 2.5. All down-lead conductors shall be fully concealed in PVC Schedule 40 conduit within the building walls. Down-lead conductors shall be protected from physical damage or displacement for a distance of not less than 8 feet above grade.

11120-3. Components

- 3.1. Provide a Franklin-rod type lightning protection system when required.
- 3.2. All materials and conductors shall be galvanically compatible. Materials acceptable for use with copper are brass, nickel, tin, and stainless steel. Materials acceptable for use with aluminum are magnesium, zinc, galvanized steel, stainless steel, and wrought iron.
- 3.3. Connections and splices shall be by exothermic weld.
- 3.4. Air terminal bases shall be cast bronze with bolted pressure cable connectors, suitable for fastening to the supporting structure.

- 3.5.** Above-grade cable connections, bonding devices, cable splices, and miscellaneous connectors shall be cast bronze with bolted pressure connections to cable and shall be electrolytically compatible with the conductor type. Cast or stamped, crimp-style fittings are not acceptable for above-grade use.
- 3.6.** Below-grade cable connections shall be exothermic type.
- 3.7.** Down-lead conductors shall be the same size and type as the main conductors if the structural steel of the building is not used.

11120-4. Master Label

- 4.1.** All lightning protection equipment shall be installed per master label requirements.
- 4.2.** A UL or equivalent master label shall be obtained after construction is completed.

11130-1. General

- 1.1. The electrical system shall be commissioned as required to assure proper operation of the equipment and systems per the intent of the construction documents.
 - 1.1.1. Coordinate with the manufacturers' recommendations for means and methods of commissioning.
 - 1.1.2. Coordinate with the third-party Commissioning Agent as necessary to meet LEED requirements.
- 1.2. The commissioning requirements for systems noted below shall be included as a minimum.
- 1.3. Refer to the LEED guidelines for any additional requirements necessary to earn LEED credit.
- 1.4. Prior to commissioning, the contractor shall complete all phases of work, including normal contractor start-up, so that the systems can be started, tested, and otherwise commissioned.
- 1.5. Provide InterNational Electrical Testing Association (NETA) testing of electrical equipment where applicable.

11130-2. Renewable Energy Systems

- 2.1. Any renewable energy systems installed shall be commissioned to ensure that the rated power of the system is achieved.

11130-3. Cathodic Protection

- 3.1. Commissioning of the cathodic protection system shall ensure that the expected results are obtained.
 - 3.1.1. Coordinate anticipated results with the type of system provided.
 - 3.1.2. Coordinate anticipated results with corrosion protection design.

11130-4. Fire Alarm System

- 4.1. Commissioning of the fire alarm system shall include the following:
 - 4.1.1. Verify the proper functioning of *every* device associated with the system.
 - 4.1.2. Verify that the device callouts within the programming of the fire alarm control panel match those of the shop drawings.
 - 4.1.3. Verify that the automatic notification system is connected to and received by the remote monitoring station.
 - 4.1.4. Perform all testing recommended and required by the NFPA and provide a completed Inspection and Testing form.

11130-5. Meters

5.1. Commissioning of meters shall:

- 5.1.1.** Verify that all metered information is accurate.
- 5.1.2.** Verify that all metered information is received and recorded by the direct digital control (DDC) system or other monitoring system designated by the BIA.

11130-6. Lighting Controls

6.1. Commissioning of lighting controls shall:

- 6.1.1.** Verify that the lighting control system(s) function as designed.
- 6.1.2.** Verify that automatic control set points are per design.

11130-7. Generator

7.1. Commissioning of the generator shall:

- 7.1.1.** Verify that the rated power of the generator system is achieved via the use of a portable load bank.
- 7.1.2.** Verify proper operation of the automatic transfer switch(es) (ATS(s)), including:
 - Load is properly transferred upon loss of normal power.
 - Load is properly transferred upon restoration of normal power.
 - Exercise clock properly exercises the generator.
 - Exercise clock is set for the correct interval for testing.

11140-1. General

- 1.1. Electrical systems training will be conducted in a classroom setting, with field demonstrations as appropriate, using system and component documentation and suitable classroom training aids.
- 1.2. The location of the training shall be determined by the Contracting Officer.
- 1.3. For all systems requiring training, a factory-authorized service representative shall be engaged to train the BIA's maintenance personnel as specified below:
 - 1.3.1. Provide training on starting up and shutting down, operating, troubleshooting, servicing, adjusting, and maintaining equipment and maintenance schedules. A minimum of three hours' training, or as noted below, shall be provided for *each* system.
 - 1.3.2. Use the approved final version of the operations and maintenance (O&M) manuals as training aids. Training shall not commence until approved O&M manuals are available.
 - 1.3.3. Training shall be scheduled with the owner with at least two weeks' advance notice.
- 1.4. All information provided in the training sessions shall be provided in written format and included in the O&M manuals. The training information shall be separated per subject for inclusion adjacent to the associated drawings, data sheets, etc., in the O&M manual.

11140-2. Switchboards

- 2.1. Provide a minimum of four hours' training.
- 2.2. The training session shall include instruction on the assembly, switches, changing fuses, checking torque on bus and cable connections, programming, viewing meter parameters, and other major components.

11140-3. Transient Voltage Surge Suppressor

- 3.1. The manufacturer's representative shall also provide training on the theory of the transient voltage surge suppressor (TVSS) system.

11140-4. Generator

- 4.1. Provide a minimum of four hours' training on the generator, automatic transfer switch (ATS), fuel systems, cooling systems, battery charger, jacket heater, and normal maintenance such as oil changes, filter changes, air filters, etc.

11140-5. Fire Alarm

- 5.1. Provide a minimum of eight hours' training.

11140-6. Other Systems to Be Included in the Training Sessions

- 6.1. Lighting controls.
- 6.2. Uninterruptible power supply (UPS).

- 6.3.** Cathodic protection.
- 6.4.** Lightning protection.
- 6.5.** Other systems requiring maintenance or troubleshooting.

11150-1. General

- 1.1. Operating and maintenance (O&M) manuals shall include information on all equipment requiring support or maintenance for proper operation.
- 1.2. O&M manuals shall be provided prior to the training sessions called out in Section 11140, "Training."
- 1.3. The O&M manuals shall contain all shop drawings and data sheets; installation, testing, and operating instructions; and maintenance requirements and procedures.
- 1.4. The O&M manuals shall contain parts lists with ordering information.
- 1.5. A written copy of the information provided at the training session(s) shall be included in the O&M manuals. The training information shall be separated by subject for inclusion adjacent to the associated drawings, data sheets, etc.

11150-2. Minimum Requirements

- 2.1. Provide O&M manuals on all equipment requiring submittal review and the following systems and equipment as a minimum:
 - Switchboards
 - Panelboards
 - Transformers
 - Generator
 - Light fixtures
 - Lighting control devices
 - Cathodic protection
 - Fire alarm
 - Lightning protection
 - UPS equipment
 - TVSS equipment
 - Metering equipment

THIS PAGE INTENTIONALLY LEFT BLANK

11160-1. General

1.1. The following details represent the information that must be presented in the construction documents.

1.1.1. Variations in the format of the presented information will be acceptable, but will require approval by the BIA.

Figure 11160-1: Sample Panel Schedule

PANEL: NAME		VOLTAGE: 277/480 V.		TYPE: LIGHTING & APPLIANCE	
FED FROM: xxx		3 PH		MOUNTING: FLUSH	
100 AMP MAIN RATED @ 80%		4 W.		PANEL COVER: DOOR IN HINGED COVER	
N/A AMP MAIN LUGS		60 HZ		NEUTRAL BUS: YES	
100 AMP BUS				GROUND BUS: YES ISOLATED GND: NO	
COPPER BUSING				NOTE: 1. []	
(SEE FAULT SCHEDULE) SYMMETRICAL RMS AMPS				2. []	
COMBINED PANEL SHORT CIRCUIT RATING				3. []	
				4. []	

NOTE	DESCRIPTION	CCT VA	BREAKER AMP / P	CCT PH CCT	BREAKER AMP / P	CCT VA	DESCRIPTION	NOTE
		0	20 / 1	1 A 2	20 / 1	0		
		0	20 / 1	3 B 4	20 / 1	0		
		0	20 / 1	5 C 6	20 / 1	0		
		0	20 / 1	7 A 8	20 / 1	0		
		0	20 / 1	9 B 10	20 / 1	0		
		0	20 / 1	11 C 12	20 / 1	0		
		0	20 / 1	13 A 14	20 / 1	0		
		0	20 / 1	15 B 16	20 / 1	0		
		0	20 / 1	17 C 18	20 / 1	0		
		0	20 / 1	19 A 20	20 / 1	0		
		0	20 / 1	21 B 22	20 / 1	0		
		0	20 / 1	23 C 24	20 / 1	0		
		0	20 / 1	25 A 26	20 / 1	0		
		0	20 / 1	27 B 28	20 / 1	0		
		0	20 / 1	29 C 30	20 / 1	0		
	SPARE	0	20 / 1	31 A 32	20 / 1	0	SPARE	
	SPARE	0	20 / 1	33 B 34	20 / 1	0	SPARE	
	SPARE	0	20 / 1	35 C 36	20 / 1	0	SPARE	
	SPARE	0	20 / 1	37 A 38	20 / 1	0	SPARE	
	SPARE	0	20 / 1	39 B 40	20 / 1	0	SPARE	
	SPARE	0	20 / 1	41 C 42	20 / 1	0	SPARE	
		0		A		0		
		0		B		0		
		0		C		0		

PANEL LOADING SUMMARY				
LOAD TYPE	PH A	PH B	PH C	TOTAL
INCANDESCENT	0	0	0	0 kVA
FLUORESCENT	0	0	0	0 kVA
RECEPTACLES	0	0	0	0 kVA
MOTORS	0	0	0	0 kVA
APPLIANCE	0	0	0	0 kVA
HEAT	0	0	0	0 kVA
COMPUTER	0	0	0	0 kVA
MISC.	0	0	0	0 kVA
--	0	0	0	0 kVA
TOTAL	0	0	0	0 kVA

PHASE BALANCE (%)					
A-B	B-C	C-A	PF		
##	##	##	##		

MIN PANEL AMPACITY		0	AMPERES

NEC DEMAND LOAD SUMMARY					
LOAD TYPE	KW	POWER		DEMAND	
		FACT	KVA	FACTOR	CALCULATED LOAD
INCANDESCENT	0	@ 100%	= 0	@ 125%	= 0 kVA
FLUORESCENT	0	@ 95%	= 0	@ 125%	= 0 kVA
RECEPTACLES					
FIRST 10 KVA	0	@ 95%	= 0	@ 100%	= 0 kVA
REMAINDER	0	@ 95%	= 0	@ 50%	= 0 kVA
MOTORS					
LARGEST	0	@ 80%	= 0	@ 125%	= 0 kVA
REMAINDER	0	@ 80%	= 0	@ 100%	= 0 kVA
APPLIANCES	0	@ 80%	= 0	@ 100%	= 0 kVA
HEAT	0	@ 100%	= 0	@ 125%	= 0 kVA
COMPUTER	0	@ 75%	= 0	@ 100%	= 0 kVA
MISC.	0	@ 85%	= 0	@ 100%	= 0 kVA
--	0	@ 95%	= 0	@ 100%	= 0 kVA
25 % SPARE	0	@ 90%	= 0	@ 100%	= 0 kVA
TOTAL	0	KW	= 0	KVA	= 0 kVA

Version 0106

Figure 11160-3: Sample Feeder Schedule

FEEDER SCHEDULE		
KEY	CONDUIT & CONDUCTORS [SEE NOTE 1]	REMARKS
15A3GM	1/2" C - 3#12, 1#12G	NOTE 5
20A2	3/4" C - 2#12	
20A3	3/4" C - 3#12	
P20A2G	3/4" C - 2#12, 1#12G	NOTE 4
125A3GM	1-1/4" C - 3#3, 1#6G	NOTE 5
30A2GM	1/2" C - 2#10, 1#10G	NOTE 5
30A5	3/4" C - 5#10	NOTE 6
50A4BJN	1-1/4" C - 3#6, 1#3N, 1#8G	NOTE 7
60A2GM	3/4" C - 2#8, 1#10G	NOTE 5
70A3G	1-1/4" C - 3#4, 1#8G	
80A4GN	1-1/2" C - 3#3, 1#1/0N, 1#8G	
100A2	1-1/4" C - 2#1	
100A2G	1-1/4" C - 2#1, 1#8G	
100A2GM	1" C - 2#4, 1#8G	NOTE 5
P100A3GM	1-1/4" C - 3#4, 1#8G	NOTES 4, 5
175A4BJN	2-1/2" C - 5#4/0, 1#2G	NOTES 2, 7
400A4BJ	2 [2-1/2" C - 4#250, 1#2G]	NOTE 7
400A4GH	2 [2-1/2" C - 4#250, 1#3G]	NOTE 3
P800A4GN	3 [3-1/2" C - 5#400, 1#1/0G]	NOTES 2, 4

Figure 11160-4: Sample Kitchen Equipment Schedule

KITCHEN EQUIPMENT SCHEDULE												
KEY	ITEM DESCRIPTION (SEE NOTE 1)	A/C VOLTS	PH	UNIT AMPS	UNIT KW	UNIT KVA	PANEL (SEE NOTE 2)	FEEDER	LOCAL DISC. SW.	ELECTRICAL CONNECTION	MOUNTING HEIGHT	REMARKS
K-0		0	0	0.0	0.0	0.0	0	#N/A	0.0	0.0	0.0	0
K-0		0	0	0.0	0.0	0.0	0	#N/A	0.0	0.0	0.0	0
K-0		0	0	0.0	0.0	0.0	0	#N/A	0.0	0.0	0.0	0
K-0		0	0	0.0	0.0	0.0	0	#N/A	0.0	0.0	0.0	0
TOTALS		0	0	0	0	0.0	0	0.0	0.0	0.0	0.0	0

Version 0106

NOTES:
 1. COORDINATE ELECTRICAL EQUIPMENT REQUIREMENTS WITH THE ACTUAL EQUIPMENT SUPPLIED.
 2. REFER TO PANEL SCHEDULES FOR EXACT CIRCUIT NUMBER.

Figure 11160-6: Sample Motor Control Center Schedule

MOTOR CONTROL CENTER SCHEDULE												
NOG No.		GP-MGD2	VOLTAGE	480V-3PH	NEMA 1	ENCLOSURE	LOCATION				CENTRAL PLANT	800 AMP MAIN BUS
NO.	MECH. EQUIP. NO.	LOAD DESCRIPTION	LOAD HP.	STARTER		SWITCH SIZE	FUSE SIZE	CONDUCTORS		CONDUIT SIZE	FLA	REMARKS
				SIZE	TYPE			PHASE	ECC			
1												
2												
3												
4												
5												
6												
7												
8												
9												
10												
11												
12												
13												

TOTAL: 132A

Figure 11160-7: Sample Device Labeling Detail

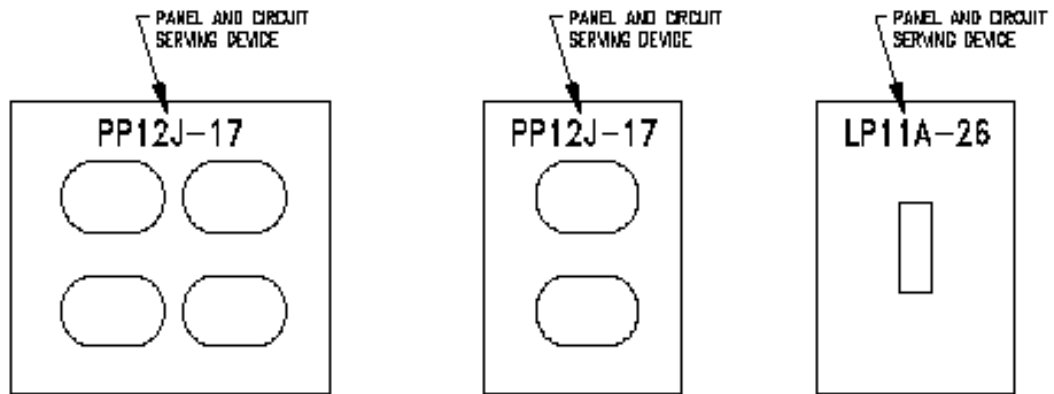
**DEVICE LABELING DETAIL**

SCALE: NONE

NOTE: LABEL WITH BROTHER "P-TOUCH" SYSTEM. PROVIDE CLEAR OR WHITE TAPE WITH BLACK LETTERING.

Figure 11160-8: Sample Mounting Height Detail

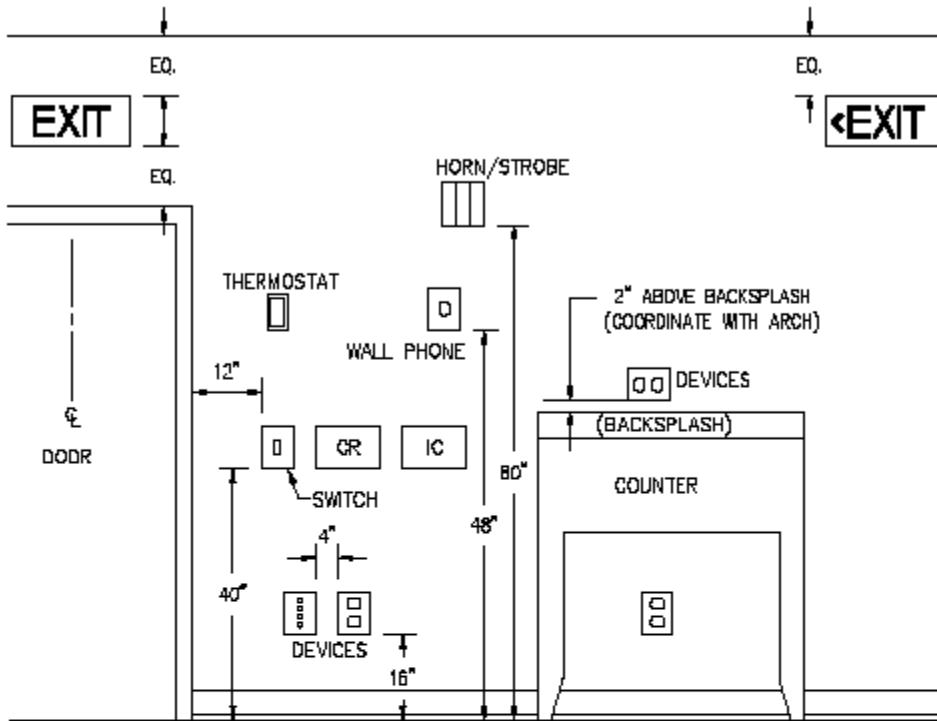

OFFICES

ELECTRICAL COMPONENT MOUNTING HEIGHTS

SCALE: NONE

NOTES:

1. HEIGHTS SHOWN ARE TYPICAL TO BOTTOM OF DEVICE UNLESS NOTED OTHERWISE.
2. DEVICES ABOVE DOORS SHALL BE CENTERED BETWEEN TOP OF DOOR TRIM AND CEILING LINE.
3. MOUNTING HEIGHTS SHOWN ON ARCHITECTURAL ELEVATIONS SHALL GOVERN OVER THOSE SHOWN ABOVE.
4. INSTALL FIRE ALARM NOTIFICATION APPLIANCES AT 80" A.F.F., OTHERWISE INSTALL AT 6" BELOW CEILING.

Figure 11160-9: Sample Transformer Schedule

480 Volt - 120/208 Volt Transformer Sizes and Feeders								
Load Type (Name)	NEC DMND. LOAD KVA	kVA	Primary		Secondary		Grounding Electrode	Remarks
			OCP	Feeder	OCP	Feeder		
Basement								
First								
Second								
Third								
Fourth								
Fifth								
Penthouse								

THIS PAGE INTENTIONALLY LEFT BLANK

12000-1. Introduction

- 1.1. This chapter shall be used as a guideline in the development of a fire protection systems performance specification for all new BIA school facilities. A qualified fire protection engineer shall work in conjunction with the architectural Designer of Record to develop the specification, which will be used by the fire protection contractor. The design shall be in conformance with these guidelines unless exceptions to them are granted by the BIA.
- 1.2. Refer to Chapter 1, “General Information,” and Chapter 2, “Presentation of Data,” for required documents, drawing and specifications formats, and other design and submittal requirements not discussed in this chapter.
- 1.3. Additional design and submittal requirements may apply for projects with unusual or highly technical criteria.
- 1.4. As applicable, the Designer of Record shall incorporate the sustainability strategies identified in Chapter 3, “LEED Goals and Guidelines.”
- 1.5. The guidelines in this chapter should be used in conjunction with those in the other chapters in this handbook, and the Designer of Record should coordinate with the other project consultants to be sure all aspects of the school facility are effective and compatible.
- 1.6. All design features must be weighed carefully for their initial cost, long-term maintenance cost and needs, durability, and their impact on the environment.
- 1.7. Fire sprinkler systems and fire suppression systems shall be provided for all new BIA school facility buildings (elementary schools, middle schools, high schools, dormitories, and associated facilities, including maintenance facilities and kitchens) in accordance with NFPA 5000 Building Construction and Safety Code, other applicable NFPA standards, and the requirements listed herein.
- 1.8. Dormitories are limited to a maximum of two stories, designed in accordance with NFPA 13 Standard for the Installation of Sprinkler Systems.
- 1.9. Refer to Section 11100, “Fire Alarm System,” for fire alarm system requirements.

12000-2. Fire Protection Engineer

- 2.1. The design of the fire protection systems shall be under the responsible charge of a qualified fire protection engineer (FPE), an individual meeting one of the following requirements:
 - 2.1.1. An engineer having a bachelor of science or master of science degree in fire protection engineering from an accredited university engineering program, plus a minimum of two years’ work experience in fire protection engineering.
 - 2.1.2. A registered professional engineer (PE) in fire protection engineering.

- 2.1.3. A registered architect (RA) with member grade status in the National Society of Fire Protection Engineers (NSFPE). Services of the RA shall be limited to building code applications and life safety code analysis.

12000-3. Fire Protection Design Analysis

- 3.1. A fire protection design analysis is required for all designs and must address the fire protection requirements of the project. The FPE, in conjunction with the architectural Designer of Record, shall be responsible for the fire protection design analysis. Where applicable, the design analysis, as a minimum, shall discuss the following:
- Building construction type, height and area limitations, and building separation and exposure protection
 - Classification of occupancy
 - Specific compliance with applicable section(s) of the NFPA's National Fire Code
 - Requirements for fire-rated walls, fire-rated doors, fire dampers with their fire-resistive ratings, smoke compartmentalization, smoke barriers, and smoke dampers
 - NFPA 5000 Building Construction and Safety Code
 - Analysis of automatic suppression systems and protected areas
 - Water supplies, including location and connection compatibility with the local fire department
 - Smoke control systems
 - Fire alarm system (the type of alarm system and location of the fire alarm equipment and fire zones)
 - Standpipe systems and fire extinguishers
 - Interior finish ratings
 - Connection to and description of the fire alarm reporting system
 - The various occupancies and hazardous areas associated with the facility
 - Coordination with security and fire protection requirements
 - Fire department access

12000-4. Design Submission

- 4.1. At the 100 percent design submission of plans and specifications, the FPE shall certify in writing that the design is in compliance with the requirements and all applicable criteria.

12000-5. Design

- 5.1. The fire protection performance specifications shall require the fire protection contractor, in conjunction with a qualified FPE, to provide detailed design (calculations and drawings) of the fire protection systems in accordance with items listed below.
 - 5.1.1. Prepare drawings and calculations showing the layout and design of the fire protection system. Coordination drawings, including all building components, shall show routing of piping, sprinkler head locations, etc. Drawings shall conform to the requirements of NFPA 13 and shall be accurately dimensioned to show the proposed location of all fire protection system components. Drawings shall be prepared on AutoCAD, and the drawing sizes shall be the same as those of the architectural Designer of Record's drawings.
 - 5.1.2. All materials and equipment used in the installation of the fire protection system shall be as approved in the Underwriters Laboratories (UL) list of inspected fire protection equipment and materials, or the Factory Mutual (FM) list of approved equipment and fire protection devices, and shall be the latest product of the manufacturer. Fire sprinkler shop drawings and calculations shall be sealed and signed by a registered fire professional engineer, who shall certify that the sprinkler installation meets both the requirements herein and applicable sections of NFPA standards.

12000-6. Coordination

- 6.1. Coordinating with other disciplines, the architectural Designer of Record and the FPE shall ensure the design includes the following:
 - 6.1.1. Flow and tamper switches are provided at all floor control valves and monitored valves.
 - 6.1.2. Smoke detectors are provided at fire/smoke dampers.
 - 6.1.3. The main test drain location is suitable for the volume of flow anticipated.
 - 6.1.4. Duct-mounted smoke detectors close the associated smoke dampers when the associated air distribution system is shut down.
 - 6.1.5. System zoning and subzoning is identified and indicated in the contract documents.
 - 6.1.6. Fire protection equipment is located to facilitate maintenance and repair or replacement of equipment components. Equipment connections are provided for ease of disconnecting and to allow minimum interference with other installations.

THIS PAGE INTENTIONALLY LEFT BLANK

12010-1. Systems Evaluation

- 1.1. Fire protection systems for BIA school facilities shall be evaluated based on the following criteria. The criteria are listed in order of priority and are followed by additional information applicable to them.

1.1.1. Critical Building Systems

- The more critical the system, the more reliable it shall be.
- If a system is determined to be essential to the operation of the building, consideration shall be given to providing system redundancy.

1.1.2. Standardization

- The design shall follow BIA standards and local fire department requirements.
- The design shall follow industry standards. Should conflicts occur between BIA and industry standards, BIA standards shall be used.

1.1.3. Training Standardization

- Systems requiring less training are preferred.

1.1.4. Operations and Maintenance Concerns

- Systems requiring less maintenance are preferred.

1.1.5. Limitation of Flexibility/Creativity

- System designs shall be well established within the industry.
- BIA facilities designed per this handbook shall have fire protection systems similar to comparable buildings at other BIA facilities that were also designed according to the guidelines in this handbook.

1.1.6. Available Infrastructure

- The available utilities shall be coordinated with the specific project site at the beginning of the project to ensure that the systems specified can be supported by the local utilities.

- 1.1.7. **Costs.** The life-cycle cost analysis of the systems shall include the following:

- Construction costs
- Operating costs
- Maintenance costs

1.1.8. *Constructability*

- The ease of construction of the proposed system shall be considered.
- The availability of workers skilled in the installation of a proposed system shall also be considered.

1.1.9. *Commissioning*

- Systems requiring less commissioning are preferred.

1.1.10. *Site Constraints and Criteria*

- The system proposed shall be compatible with site constraints and requirements.

1.1.11. *Climate Influences*

- The system proposed shall be compatible with the climate of the project site.

1.1.12. *Infrastructure Flexibility/Expandability*

- The system design shall be able to accommodate future expansion as required by the BIA.

- 1.2.** Where a clear system selection is *not* readily determined by examining the above criteria, present the information available, relative to those criteria, to the BIA for review and selection.

12020-1. General

- 1.1. For the design of fire protection systems for BIA school facilities, follow all applicable current codes, standards, and laws. For a more general list of codes and standards that apply to BIA educational facilities, refer to Chapter 1, “General Information.” During design, report any required deviations from codes and standards to the Contracting Officer.
- 1.2. Where two codes, standards, or laws are applicable to the topic under review, use the more conservative or more stringent. In the case of conflict, follow the requirement that provides the highest level of safety (as determined by the fire protection engineer) unless contrary instruction is given in writing by the BIA. Consult with the BIA Office of Facilities Management and Construction (OFMC) to resolve any questions or conflicts regarding application of codes and standards.
- 1.3. The ARCOM MASTERSPEC, Division 21, along with the standards and guidelines in the publications listed below, shall be used as references for specification development.
- 1.4. All appendices of referenced NFPA standards shall be considered part of the applicable standards for design and interpretation purposes.
- 1.5. Nothing in this handbook shall be construed to relieve the fire protection engineer (FPE) or the contractor of their responsibility with respect to applicable codes, laws, or ordinances.

12020-2. Applicable Codes and Standards

- 2.1. The design criteria shall comply with the guidelines contained in the following:

2.1.1. *American National Standards Institute (ANSI)*

ANSI/

ASME A17.1 Safety Code for Elevators and Escalators

2.1.2. *American Society of Mechanical Engineers (ASME)*

ASME B16.1 Cast Iron Pipe Flanges and Flanged Fittings

ASME B16.3 Malleable Iron Threaded Fittings

ASME B16.4 Gray Iron Threaded Fittings

ASME B16.9 Factory-Made Wrought Butt Welding Fittings

ASME B16.11 Forged Fittings, Socket-Welding and Threaded

ASME B16.18 Cast Copper Alloy Solder Joint Pressure Fittings

ASME B16.21 Nonmetallic Flat Gaskets for Pipe Flanges

ASME B16.22 Wrought Copper and Copper Alloy Solder Joint Pressure Fittings

ASME B18.2.1 Square and Hex Bolts and Screws, Inch Series

ASME B18.2.2 Square and Hex Nuts

2.1.3. American Society of Sanitary Engineering (ASSE)

ASSE 1015 Performance Requirements for Double Check Backflow Prevention Assemblies and Double Check Fire Protection Backflow Prevention Assemblies

2.1.4. American Society for Testing and Materials (ASTM)

ASTM A47 Standard Specification for Ferritic Malleable Iron Castings

ASTM A53 Standard Specification for Pipe, Steel, Black and Hot-Dipped, Zinc-Coated, Welded and Seamless

ASTM A135 Standard Specification for Electric-Resistance-Welded Steel Pipe

ASTM A183 Standard Specification for Carbon Steel Track Bolts and Nuts

ASTM A536 Standard Specification for Ductile Iron Castings

ASTM A795 Standard Specification for Black and Hot-Dipped Zinc-Coated (Galvanized) Welded and Seamless Steel Pipe for Fire Protection Use

ASTM B88 Standard Specification for Seamless Copper Water Tube

2.1.5. American Water Works Association (AWWA)

AWWA-01 Standard Methods for the Examination of Water and Wastewater

AWWA B300 Hypochlorites

AWWA B301 Liquid Chlorine

AWWA ANSI / Cement-Mortar Lining for Ductile-Iron Pipe and
AWWA C104 / Fittings for Water
A21.4

AWWA ANSI / Ductile-Iron and Gray-Iron Fittings for Water
AWWA C110 /
A21.10

AWWA ANSI / Rubber-Gasket Joints for Ductile-Iron Pressure Pipe
AWWA C111 / and Fittings
A21.11

AWWA ANSI / Ductile-Iron Pipe, Centrifugally Cast, for Water or
AWWA C151 / Other Liquids
A21.51

AWWA C203	Coal-Tar Protective Coatings & Linings for Steel Water Pipelines, Enamel & Tape, Hot-Applied
AWWA M20	Water Chlorination/Chloramination Practices and Principles

2.1.6. *Factory Mutual Engineering and Research (FM)*

FM P7825a	Approval Guide Fire Protection
FM P7825b	Approval Guide Electrical Equipment

2.1.7. *Manufacturers Standardization Society of the Valve and Fittings Industry (MSS)*

MSS SP-71	Gray Iron Swing Check Valves, Flanges and Threaded Ends
-----------	---

2.1.8. *National Fire Protection Association (NFPA)*

NFPA 13	Standard for the Installation of Sprinkler Systems
NFPA 14	Standard for the Installation of Standpipes and Hose Systems
NFPA 20	Standard for the Installation of Stationary Pumps for Fire Protection
NFPA 24	Standard for the Installation of Private Fire Service Mains and Their Appurtenances
NFPA 25	Standard for the Inspection, Testing, and Maintenance of Water-Based Fire Protection Systems
NFPA 214	Standard on Water-Cooling Towers
NFPA 1963	Standard for Fire Hose Connections
NFPA 5000	Building Construction and Safety Code

2.1.9. *National Institute for Certification in Engineering Technologies (NICET)*

NICET 1014	Automatic Sprinkler System Layout [Program Detail Manual for Certification in the Field of Fire Protection Engineering Technology]
------------	--

2.1.10. *Underwriters Laboratories (UL)*

UL	Building Materials
UL	Fire Protection Equipment

THIS PAGE INTENTIONALLY LEFT BLANK

12030-1. General

- 1.1. **Automatic Fire Suppression Systems.** The engineered and installed automatic fire suppression systems in BIA school facilities shall be designed to distribute water or a suppression agent in sufficient quantity to either control or extinguish the fire.
- 1.2. **Connections to Fire Reporting Systems.** Fire suppression systems must be connected to the fire reporting system for transmission of fire alarms, trouble signals, and supervisory signals.
- 1.3. **Plans and Calculations.** Fire suppression specifications must include provisions regarding fire suppression contractor qualifications. Sprinkler shop drawings shall be sealed and signed by a registered fire professional engineer (PE), who shall certify that the sprinkler installation meets the requirements herein and applicable sections of NFPA codes and standards. Submit the fire suppression system calculations and construction (shop) drawings to the designated fire protection engineer (FPE) for approval.
- 1.4. **Water Flow Testing.** Water flow tests shall be conducted to determine available water quantities and pressures for the fire protection systems. The FPE shall witness the required flow testing and verify that the test results are accurate. Accepting historical water supply information or similar data without verification is *not* permitted. Conduct water flow tests prior to the concept design submission.

12030-2. Automatic Suppression Systems

- 2.1. Automatic sprinkler systems shall be designed in accordance with NFPA 5000, NFPA 13, and the requirements herein.
- 2.2. **Application Requirements.** Complete automatic sprinkler protection must be provided in all new BIA schools and associated buildings. Kitchen hoods shall be protected utilizing wet chemical, dry chemical, or wet sprinkler systems. A clean agent (FM-200) system may be used for computer/server rooms. Carbon dioxide systems shall *not* be used for BIA schools and associated buildings.
 - 2.2.1. Coverage shall include 100 percent of the building, including electrical rooms, boiler rooms, telephone rooms, and mechanical rooms.
 - 2.2.2. The BIA requires that all Bureau-owned buildings exceeding 2,000 square feet in gross floor area, regardless of occupancy, be fully sprinkled with automatic sprinkler protection in accordance with NFPA 13, using Ordinary Hazard occupancy classification as the minimum design risk factor.
 - 2.2.3. Sprinkler systems shall be designed using hydraulic calculations. A pipe schedule design is not allowed.
 - 2.2.4. For dry pipe systems, the design area of the sprinkler operation must be increased by 30 percent per NFPA 13.

- 2.2.5.** The design areas must be increased by 30 percent for sloped ceilings that exceed a pitch of 1 in 6.
- 2.2.6.** The use of quick-response automatic sprinklers (QRASs) is limited to wet systems.
- 2.2.7.** Provide a separate, independent branch line system with a shutoff valve for the elevator equipment room and hoistway to meet the requirements of ANSI/ASME A17.1 and local codes. The hoistway and machine room shall be classified Ordinary Hazard. Install a shutoff valve outside of the shaft and equipment room.
- 2.2.8.** Standpipe systems shall have a 2½-inch outlet with a valve connection. Coordinate the location of the fire department's connection and standpipe connection with the fire department.
- 2.2.9.** Fire pumps are not to be used without prior approval. Calculations shall be submitted to show that a pump is necessary to meet the sprinkler and standpipe requirements.
- 2.2.10.** The inspector's test valve locations are to be located at the highest and most remote location on the piping system (not on the riser near the drain).
- 2.2.11.** When outside post indicating valves are required, they must be supervised.
- 2.2.12.** Double-check backflow preventers are required on all fire sprinkler systems.
- 2.2.13.** Sprinkler systems shall be zoned with floor/area control valves.
 - 2.2.13.1.** System Zoning: Zoning and subzoning shall be identified and indicated in the contract documents.
- 2.2.14.** Install supervisory/tamper switches on all control valves.
- 2.2.15.** Sprinklers subject to damage and/or located within 7 feet 0 inches of the floor and sprinklers protecting electrical or mechanical rooms shall be provided with approved guards.
- 2.2.16.** Tamper/supervisory switch signals shall initiate a unique supervisory alarm signal at the building fire alarm control panel (FACP).
- 2.2.17.** Other system supervisory signals shall provide unique indications of system supervisory status.
- 2.2.18.** Dry pendant heads may be used in areas that are subject to freezing if adequate coverage can be achieved; otherwise, dry pipe sprinkler systems or antifreeze additive to wet systems shall be used.
- 2.2.19.** Required pressure gauges shall be equipped with a shutoff valve and with provision for draining.

12030-3. Water Supply

- 3.1. **Civil.** Refer to Chapter 5, “Civil,” for information on hydrant requirements, storage tanks, and other fire-related equipment located outside the building.
- 3.2. Flow velocity in underground water mains shall not exceed 16 feet per second. Velocity in above-ground sprinkler system piping shall not exceed 20 feet per second.
- 3.3. **Distribution Mains.** The distribution system must be sized to accommodate fire flows (sprinkler plus hose stream) plus domestic or industrial demands that cannot be restricted during fires. Distribution must be looped to provide at least 50 percent of the required fire flow in case of a single break. Dead-end mains must be avoided. Distribution systems must be designed in accordance with NFPA 24 and the American Water Works Association Manual M31 Distribution System Requirements for Fire Protection. Coordinate with the civil engineer.
- 3.4. Provide a pressure gauge on the street side of the check valves.
- 3.5. **Flow Test Pressure Data.** Hydraulic calculations shall be based on 90 percent of the flow test pressure data to accommodate for seasonal and future reductions in available flow/pressure.
- 3.6. The possibility of microbiologically influenced corrosion (MIC) shall be considered by the FPE. If MIC is determined to be a potential problem, action such as testing and evaluation of the sprinkler water shall be taken to prevent/minimize the risk. Refer to the NFPA for additional information regarding evaluation and test methods for MIC.

12030-4. Fire Pumps

- 4.1. **Requirements.** Pumps for fire protection must have adequate capacity with reliable power and water supply. This equipment must conform to the requirements of NFPA 20. Fire pumps, drivers, and other equipment, including automatic accessories, must be UL listed, Factory Mutual (FM) approved, or listed or classified by a nationally recognized testing laboratory.
- 4.2. Fire pumps must be located in a detached, noncombustible pump house, or located in a two-hour fire-rated room (a one-hour rated room where the pump room is sprinkled) with direct access from the exterior.
- 4.3. A secondary fire pump must be provided when the water supply cannot support 25 percent of the sprinklers in the hydraulically most remote design area with the primary fire pump out of service.
- 4.4. **Pump Type.** A fire pump may be either a horizontal or vertical shaft centrifugal pump or a vertical shaft turbine pump, whichever is most economical and appropriate for the intended use.
- 4.5. **Pump Starting Arrangement.** Fire pumps must be arranged to start automatically.

- 4.6. **Pump Shutdown.** Once started, fire pumps must be arranged to run until they are shut down manually.

Exception 1: Operation by automatic periodic exercise timers used for the required preventive maintenance run times.

Exception 2: Automatic shutdown upon total exhaustion of suction reservoir water may be permitted.

- 4.7. **Jockey Pump.** Provide a pressure maintenance pump to make up the allowable leakage rate in the system. The pump shall be of the size and capacity required by the system and the NFPA. The jockey pump shall be controlled by a combination magnetic starter operating in conjunction with a pressure switch. The combination starter shall be equipped with three coil overloads and shall have a hand-off-auto (H-O-A) switch in the cover.

- 4.8. **Pump Drive.** When electric power is economically available, from a reliable single power source or from two independent sources in accordance with NFPA 20, pumps must be electrically driven only. A reliable single power source is defined as a power source having an average forced downtime, excluding scheduled repairs, that does not exceed 8 consecutive hours for any one incident or more than 24 hours cumulatively over the last three years. When such electrical power supplies are not available, fire pumps must be diesel driven. Spark-ignited internal combustion engines must not be used to drive fire pumps.

Exception: A diesel-driven fire pump does not have to be provided when the fire pump is equipped with an automatic transfer switch and connected to an emergency generator.

12030-5. Fire Pump Controller

- 5.1. The fire pump controller shall be UL listed and FM approved for fire pump service. The controller shall meet the requirements of NFPA 20. It shall be completely factory wired, assembled, and tested prior to shipment. The controller shall be of the combined manual/automatic type sized to operate the fire pump motor and designed for reduced-voltage, auto-transformer type starting. All controller components shall be UL listed or UL recognized and shall be front mounted and wired, allowing the controller to mount flush against a wall.
- 5.2. The circuit breaker shall have an integral, nonadjustable instantaneous trip mechanism. The controller shall include a full National Electrical Manufacturers Association (NEMA)-rated contactor capable of operation by an external emergency operating handle. (An International Engineering Consortium (IEC)-only rated contactor will not be acceptable.)
- 5.3. A bourdon tube-type pressure switch with adjustable independent high and low set points and an appropriate range shall also be furnished. The pressure switch shall be sealable to prevent unauthorized adjustment. The pressure switch shall be mounted inside the controller cabinet.

- 5.4. An externally mounted pilot light shall be furnished to indicate that controller primary power is available.
- 5.5. Dry alarm contacts for remote alarm of "Pump Running," "Controller Power Available," and "Phase Reversal" shall be supplied. One normally open and one normally closed contact for each alarm shall be supplied. Controller power shall be monitored by the associated automatic transfer switch.

12030-6. Automatic Transfer Switch

- 6.1. **General.** The automatic transfer switches shall provide manual or automatic operation of electric fire pump controllers from an alternate source of power when the normal source fails. The transfer switch is a part of the fire pump controller, and although mounted in a separate compartment, shall be factory assembled, shipped, and installed as a part of the controller. The transfer switch shall be rated for the intended duty and coordinated with the electrical contractor.
- 6.2. **Alarm Contacts.** An auxiliary, normally open contact shall be provided for the remote annunciation of the transfer switch position.
- 6.3. **Additional Features.** Supply a test switch that simulates the loss of normal power in order to test the operation of the transfer switch without interrupting normal service to the fire pump controller. Two pilot lights shall be provided on the outside of the transfer switch enclosure: one for normal position and one for emergency position, to give visual indication of the switch position. The pilot lights shall be controlled by auxiliary contacts off the transfer mechanism to ensure positive indication of switch position.

12030-7. Standpipes

- 7.1. When required, standpipe systems must be installed in accordance with NFPA 5000, NFPA 14, and the requirements herein.

Exception: Residual pressure requirements specified in NFPA 14 may be omitted for buildings less than 150 feet in height where fire department apparatus are expected to boost pressure in standpipe systems.

12030-8. Elevator Machine Rooms and Hoistways

- 8.1. Provide 286°F sprinklers, with head guards, in elevator machine rooms and hoistways (where required). Sprinklers are required at the top of hoistways per NFPA 13 (except where the hoistway for a passenger elevator is noncombustible and the car enclosure materials meet the requirements of ANSI/ASME A17.1). Sprinklers are not required at the bottom of noncombustible hoistways for elevators that do not use hydraulic fluid.
- 8.2. Provide a control valve with a tamper/supervisory switch outside elevator machine rooms and shafts.
- 8.3. Provide smoke detectors for elevator recall.

- 8.4. Provide one 190°F fixed-temperature non-resetting heat detector adjacent to each sprinkler. After the elevator is recalled and prior to the application of water, heat detectors shall automatically disconnect power to the elevator machinery and the elevator controller. Provision of detectors and power disconnects is normally under the Electrical division of the project specifications. Coordinate between mechanical and electrical disciplines for proper detector and sprinkler locations.
- 8.5. Supervision of detectors shall be included under the Electrical division of the project specifications.
- 8.6. Each bank of elevators and associated equipment rooms shall be protected by an independent system unless determined otherwise by the FPE and approved by the BIA.

12030-9. Dry Pipe Systems

- 9.1. The system shall be monitored for low gas pressure.
- 9.2. A slope shall be provided as required for dry systems per NFPA 13. All trapped sections of piping shall be provided with auxiliary drains as required by NFPA 13. All drains shall have minimum 1-inch valves with a plug at all low points.
Note: This requirement exceeds the provisions of NFPA 13.
- 9.3. A valve shall be located within an artificially lighted and heated enclosure.
- 9.4. A valve shall be installed in the vertical position at 24 inches to 48 inches above the finished floor (AFF).

12030-10. Piping

- 10.1. All piping shall be USA-manufactured Schedule 10 or 40 piping for 2½-inch and larger, and Schedule 40 steel for all piping 2-inch and smaller as required by NFPA 13. Threaded thin-wall piping may not be used.
- 10.2. Copper tubing may be used if identified as desirable by the FPE. Full compliance with NFPA 13 requirements and recommendations is required.
- 10.3. Pipe joining: Fittings shall comply with NFPA 13 requirements. Grooved couplings, fittings, and gaskets used throughout a system shall be supplied from the same manufacturer and designed for the specific installation.
- 10.4. Threaded fittings are preferred in architecturally exposed or sensitive areas.
- 10.5. Design, hydraulic data, and fabrication documentation shall be submitted on the use of segmentally welded fittings.
- 10.6. Threaded and cut-grooved pipes are subject to the limitations of NFPA 13.
- 10.7. Face bushings and hexagonal bushings shall not be permitted.
- 10.8. Galvanized pipe may be necessary for drain lines as determined by the FPE. Dry pipe systems may use galvanized pipe as deemed necessary by the FPE.

12030-11. Drain and Test Valves

- 11.1.** All main drains shall discharge to the building exterior through a properly sized drain riser. The FPE shall determine the routing of the drain and discharge locations and shall indicate these on the drawings.
- 11.1.1.** Sight glasses shall be provided on all inspectors' test connections where discharge cannot be seen while valves are operated.
- 11.1.2.** All drains shall be piped to the outside of the building at a point that won't cause water damage, and shall terminate with a 45-degree elbow. This includes the drain for the fire department connection piping (exception: auxiliary drains). The contractor shall supply and install a concrete splash block with a minimum length of 4 feet to direct the drain or test discharge water so as not to disturb adjacent landscape.
- 11.1.3.** Drain valves shall be made accessible and operable from the floor unless otherwise proposed by the FPE and accepted in writing by the BIA.
- 11.1.4.** Galvanized pipe may be necessary for drain lines as determined by the FPE.

12030-12. System Zoning

- 12.1.** Zoning and subzoning shall be identified and indicated in the contract documents. For buildings of more than three stories, each floor shall be a separate zone. Floor areas of greater than 26,000 square feet shall be a separate zone.

Note: This exceeds the NFPA requirement.

12030-13. Identification Signs

- 13.1.** Provide identification signs at all control, drain, test, and alarm valves. Signs shall be of the type and size and at the location required by the NFPA.

12030-14. Seismic Considerations

- 14.1.** In areas where seismic site classification warrants the design of seismic restraints for fire suppression systems, a seismic design shall be provided to comply with performance requirements and design criteria, including analysis data signed and sealed by the qualified licensed professional engineer responsible for their preparation in accordance with NFPA requirements.

THIS PAGE INTENTIONALLY LEFT BLANK

Figure 12040-1: Fire Sprinkler Zone Control Valve

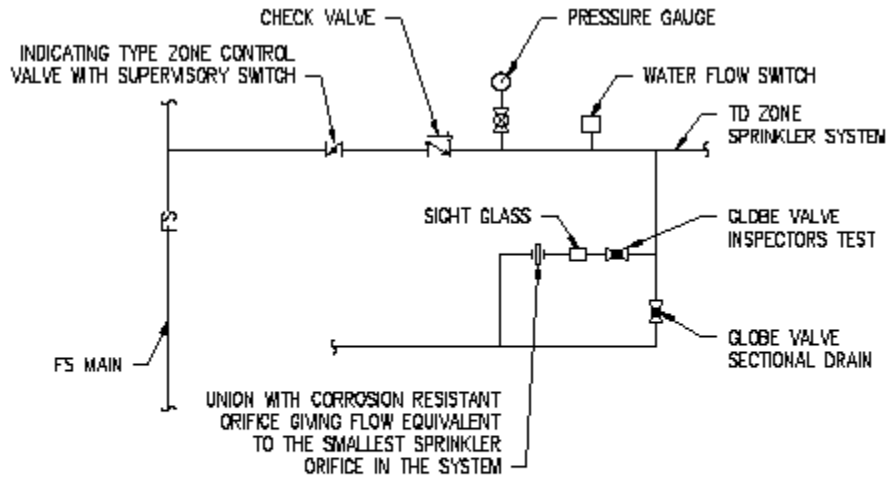

FIRE SPRINKLER ZONE CONTROL VALVE DETAIL

SCALE: NONE

THIS PAGE INTENTIONALLY LEFT BLANK

13000-1. Introduction

- 1.1. This chapter shall be used as a guideline for the design of information technology (IT) systems for all new BIA school facilities. The design shall be in conformance with these guidelines unless exceptions to them are granted by the BIA.
- 1.2. Refer to Chapter 1, “General Information,” and Chapter 2, “Presentation of Data,” for required documents, drawing and specifications formats, and other design and submittal requirements not discussed in this chapter.
- 1.3. Additional design and submittal requirements may apply for projects with unusual or highly technical criteria.
- 1.4. As applicable, the Designer of Record shall incorporate the sustainability strategies identified in Chapter 3, “LEED Goals and Guidelines.”
- 1.5. The guidelines in this chapter should be used in conjunction with those in the other chapters in this handbook, and the Designer of Record should coordinate with the other project consultants to be sure all aspects of the school facility are effective and compatible. Architectural, electrical, and mechanical design considerations, as they relate to IT, are detailed herein; it is the IT Designer of Record’s responsibility to coordinate these considerations with the architect, electrical engineer, and mechanical engineer.
- 1.6. All design features must be weighed carefully for their initial cost, long-term maintenance cost and needs, durability, and their impact on the environment.
- 1.7. The information and “best practice” approaches described in this chapter are based on the belief that information technology is similar to electrical power—a fundamental resource that should be readily available and easy to use, ubiquitous yet unobtrusive. Technology is a utility, a tool, and not an end in itself. With this in mind, IT systems for BIA schools should be easy to use and maintain, standards based, and consistent across all schools.
- 1.8. It is strongly recommended that IT systems be designed by a consulting and/or engineering firm with one or more registered communications distribution designers (RCDD) on staff, who are in turn responsible for the IT design. An RCDD is a technical designation given to individuals who demonstrate design proficiency with technology systems. Most technology consulting firms have staff members with an RCDD designation, as do some electrical engineering firms.

13000-2. Documents

- 2.1. It is recommended that IT systems be specified under their own division within the project specifications, and that they be shown on a T series of drawings. Some materials and equipment traditionally considered more electrical in nature, such as communications pathway infrastructure and telecommunications grounding/bonding, will be specified under the Electrical division within the project technical specifications, and will be shown on the E series of drawings.

13000-3. IT Systems Selection

- 3.1.** The type and complexity of IT systems, and/or whether a particular system is necessary, will depend largely upon the type of school, its size, and its location. There may also be special cases that justify the need for a particular system.
- 3.2.** Dormitories will also have some IT requirements, although fewer than those of a school.

13000-4. IT Systems Construction

- 4.1.** It is recommended that the technology systems be constructed by a contractor directly subcontracted to the general contractor, not the electrical contractor. This avoids a layer of cost markup that is typically not necessary and also facilitates coordination among the various trades on the job site.

13010-1. IT Systems Selection Matrix

1.1. The matrix in this section is intended to provide an overview of IT systems to be included in a school, and to aid in selecting or sizing the systems based upon specified criteria. It is not intended to be all-inclusive, nor is it intended to be used to exclude a system should conditions clearly indicate a need for it. After applying the matrix to the IT systems, the IT Designer of Record should review the selected and excluded systems with the BIA.

1.2. How to Use the Matrix

- 1.2.1. IT systems are listed in the left-hand column of the matrix, and selection criteria are listed in the remaining columns. Systems and features that require special justification for use are noted in the Special Case Justification column.
- 1.2.2. Selection criteria columns are additive. That is, all criteria that are selected for a given system are added to all other criteria selected for that system. For example, for the system Main Pathway System – J-Hooks/Straps, all of the School Type criteria are selected, but for School Size, only Small and Medium are selected. This means that for all school types, only small and medium schools will have a J-hook/strap system. Similarly, all types of schools will have a cable tray system, but only if they are large or very large; small and medium schools, as well as dormitories, will not.
- 1.2.3. The only selection criterion that is not additive is the Special Case Justification criterion. If this criterion is selected, it may override the other criteria.
- 1.2.4. The IT Systems Selection Matrix is designed to be used in conjunction with, not exclusive of, this narrative. Together, these documents provide the guidelines by which IT systems can be evaluated, sized, and selected.

13010-2. Selection Criteria

- 2.1. When specifying appropriate information technology systems, the Designer of Record should consider the following factors/criteria and the impact of these on each facility:
 - 2.1.1. *Special Case Justification.* Some systems should be provided only on a case-by-case basis, based upon anticipated, historical, and/or local needs.

2.1.2. *Size.* School needs are often defined by size; small schools do not have the same requirements as do large schools. To aid the Designer of Record in determining technology needs, school sizes as categorized in the IT Systems Selection Matrix are as follows:

- Small: less than 25,000 square feet
- Medium: 25,000 – 45,000 square feet
- Large: 45,000–90,000 square feet
- Very large: more than 90,000 square feet

2.1.3. *Type.* The following types (student age group) of schools and associated facilities are categorized in the IT Systems Selection Matrix as follows:

- K–6
- K–8/7–8
- K–12
- 9–12
- Dormitories

2.1.4. *Ease of Use and Maintenance.* In addition to the above criteria, ease of use and maintenance of IT systems is also critical. Systems that require extensive training to use and/or highly skilled personnel to maintain should be avoided to the extent possible. The IT systems ultimately selected for a school should be those that provide for optimal ease of use and maintenance while satisfying the stated performance criteria. In some cases, this may mean providing systems that are initially more costly, but that will have markedly lower maintenance costs or are substantially easier to use.

Figure 13010-1: IT Systems Selection Matrix

(see next page)

IT Systems Selection Matrix										
	Special Case Justification	Size				Type				
		Small (<25k sf)	Medium (25-45k sf)	Large (45-90k sf)	Very Large (>90k sf)	K-6	K-8 / 7-8	K-12	9-12	Dorms
Information Technology System										
Communications Rooms										
Telecom Room(s) (TR)		•	•	•	•	•	•	•	•	•
Entrance Facility (EF)		•	•	•	•	•	•	•	•	•
Server Room					•	•	•	•	•	•
Communications Cabling System										
Backbone Cabling										
<i>Inside Plant</i>										
Copper, Multimode Fiber, CATV Coax			•	•	•	•	•	•	•	•
Singlemode Fiber			•	•	•	•	•	•	•	•
<i>Outside Plant (for multi-building campuses)</i>										
Copper, Multimode Fiber, Singlemode Fiber, CATV Coax		•	•	•	•	•	•	•	•	•
Horizontal Cabling										
Category 6		•	•	•	•	•	•	•	•	•
CATV Coax		•	•	•	•	•	•	•	•	•
Communications Pathway System										
Device Box/Conduit to accessible space		•	•	•	•	•	•	•	•	•
Main Pathway System - Cable Tray				•	•	•	•	•	•	•
Main Pathway System - J-Hooks/Straps		•	•			•	•	•	•	•
Floor Box/Poke-thru	•									
Outside Plant Pathway		•	•	•	•	•	•	•	•	•
Communications Grounding and Bonding System										
		•	•	•	•	•	•	•	•	•
Outside (Service Provider) Connectivity										
Voice (Dial Tone)		•	•	•	•	•	•	•	•	•
Data (Internet)		•	•	•	•	•	•	•	•	•
Security System										
<i>Access Control</i>										
Key Access		•	•	•	•	•	•	•	•	•
Card Access	•									
Controlled Entryways - Interior			•	•	•	•	•	•	•	•
Controlled Entryways - Exterior			•	•	•	•	•	•	•	•
Monitored Entryways			•	•	•	•	•	•	•	•
<i>Video Surveillance System</i>										
Public entryways		•	•	•	•	•	•	•	•	•
Playground areas		•	•	•	•	•	•	•	•	•
Parking areas		•	•	•	•	•	•	•	•	•
Bus areas		•	•	•	•	•	•	•	•	•
Public areas				•	•	•	•	•	•	•
Corridors				•	•			•	•	•
Recording Capability	•									
<i>Intrusion Detection</i>										
<i>Metal Detector</i>	•									
Room Technology Systems										
<i>Sound Reinforcement</i>										
Classrooms		•	•	•	•	•	•	•	•	•
Gymnasiums/Theaters		•	•	•	•	•	•	•	•	•
<i>Video Projection</i>										
<i>Video Projectors</i>										
Mobile		•	•	•	•	•	•			
Permanent		•	•	•	•			•	•	
<i>Video Projection Surfaces</i>										
Non-glare White Boards		•	•	•	•	•	•	•	•	•
Portable Projection Screens		•	•	•	•	•	•	•	•	•
Motorized Projection Screens	•									
Infrastructure for Interactive White Board		•	•	•	•	•	•	•	•	•
<i>Distance Learning System</i>										
Portable Cart System		•	•	•	•				•	
Data Network System										
Data Networking Equipment (PoE Capable)		•	•	•	•	•	•	•	•	•
Wireless Networking Equipment		•	•	•	•	•	•	•	•	•
Telephone (VoIP) System										
Telephone system		•	•	•	•	•	•	•	•	•
Intercom system (part of Telephone System)		•	•	•	•	•	•	•	•	•
Public Address and Bell System										
Public address system		•	•	•	•	•	•	•	•	•
Bell system		•	•	•	•	•	•	•	•	•
Clock System										
		•	•	•	•	•	•	•	•	•
Radio System										
	•									

THIS PAGE INTENTIONALLY LEFT BLANK

13020-1. General

- 1.1. For IT design, follow all applicable current codes, standards, and laws. For a more general list of codes and standards that apply to BIA educational facilities, refer to Chapter 1, “General Information.” During design, report any required deviations from codes and standards to the Contracting Officer.
- 1.2. Where two codes, standards, or laws are applicable to the topic under review, use the more conservative or more stringent. Consult with the BIA Office of Facilities Management and Construction (OFMC) to resolve any questions or conflicts regarding application of codes and standards.
- 1.3. Standards for IT systems will primarily consist of the Telecommunications Industry Association/Electronics Industries Alliance (TIA/EIA) telecommunications standards and the applicable standards published by the Institute of Electrical and Electronics Engineers (IEEE). Guidelines based upon these standards will also be used, the most notable of which are the materials published by BICSI.
- 1.4. Standards-based systems will enable BIA schools to make use of consistent training and operations and maintenance (O&M) information across all facilities, and in turn enable personnel moving between schools to immediately use and/or maintain the IT systems with little or no additional training. Technical knowledge will be consistent and thus more readily available, allowing staff to share knowledge between facilities and to provide each other with assistance when necessary.
- 1.5. In addition to the standards guidelines noted above and listed below, all IT installations will comply with any pertinent national, state, local, or tribal regulations.

13020-2. Applicable Codes and Standards

- 2.1. The design criteria shall comply with the guidelines contained in the following:
 - Americans with Disabilities Act and Architectural Barriers Act Accessibility Guidelines (ADAABAAG)
 - American National Standards Institute (ANSI)/TIA J-STD-607 Commercial Building Grounding and Bonding Requirements for Telecommunications
 - ANSI S12.60 Acoustical Performance Criteria, Design Requirements, and Guidelines for Schools
 - BICSI *Customer-Owned Outside Plant Design Manual*
 - BICSI *Information Transport Systems Installation Manual*
 - BICSI *Telecommunications Distribution Methods Manual*
 - IEEE 802.3 (series) Local Area Network Ethernet Standards

- National Fire Protection Association (NFPA) 70 National Electrical Code (NEC)
- NFPA 5000 Building Construction and Safety Code
- OSHA Occupational Safety and Health Standards
- TIA/EIA-568 Commercial Building Telecommunications Cabling Standard
- TIA/EIA-569 Commercial Building Standard for Telecommunications Pathways and Spaces
- TIA/EIA-570 Residential Telecommunications Cabling Standard
- TIA/EIA-606 Administration Standard for Commercial Telecommunications Infrastructure
- TIA/EIA-758 Customer-Owner Outside Plant Telecommunications Cabling Standard

13030-1. General

- 1.1. Communications rooms primarily consist of telecommunications rooms (TRs) and entrance facilities (EFs); some school facilities will also have server rooms.
- 1.2. Properly sized, located, and provisioned communications rooms are critical to the ability of the facility to grow with and accommodate technology systems as those systems change over time.
- 1.3. Refer to the *BIA School Facilities Space Templates* for typical layouts of these spaces.

13030-2. Telecommunications Rooms

- 2.1. Telecommunications rooms provide a connection point between backbone and horizontal (outlet) cabling, and house equipment for the data network, voice, and other communications systems, such as current or future cable television (CATV), alarms, security, access control, and building automation systems. Telecommunications rooms were formerly known as Intermediate Distribution Frame (IDF) and Main Distribution Frame (MDF) rooms.
- 2.2. Every facility will include a primary TR. Facilities requiring additional TRs (based upon size) shall include one or more secondary TRs. The type and quantity of equipment racks will vary depending upon whether the TR is primary or secondary.
- 2.3. The two long walls of each TR will be covered with 8-foot-high backboards (3/4-inch-thick fire treated). Ladder racking will be provided along each wall, with an additional ladder rack running parallel to and affixed above the equipment racks.

2.3.1. Equipment Racks

- 2.3.1.1. School Primary TR: Typically, two free-standing equipment (2-post) racks and two free-standing equipment (4-post) frames will reside within a primary TR (one rack for station cabling, one rack for backbone cabling, and two equipment frames for equipment) centered longitudinally within the room. The school primary TR shall have space for one future equipment rack/frame to be installed at one end. However, this configuration may change depending upon the size of the primary TR, whether the primary TR is also serving as an EF or server room, and the size and amount of equipment to be installed within it. The IT Designer of Record should determine the type and amount of equipment to be installed in the primary TR before finalizing the size.
- 2.3.1.2. Dormitory Primary TR: Typically, two free-standing equipment (2-post) racks and one free-standing equipment (4-post) frame will reside within a primary TR (one rack for station cabling, one rack for backbone cabling, and one equipment frame for equipment) centered longitudinally within the room. Space for a future equipment

rack/frame is not typically required. However, this configuration may change depending upon the size of the primary TR, whether the primary TR is also serving as an EF or server room, and the size and amount of equipment to be installed within it. The IT Designer of Record should determine the type and amount of equipment to be installed in the primary TR before finalizing the size.

- 2.3.1.3. School Secondary TR: Typically, three free-standing equipment racks will reside within a secondary TR (one for station cabling, one for backbone cabling, and one for equipment) centered within the room along the long wall. This configuration may change depending upon the size of the TR and the size and amount of equipment to be installed within it.
- 2.3.1.4. Dormitory Secondary TR: This room is very similar to a School Secondary TR, although fewer free-standing equipment racks may be required.

2.4. Architectural Considerations

- 2.4.1. It is preferable to locate TRs in building core areas, and in areas more central to the space to be served. Ceiling space within TRs should be left open—false/suspended ceilings are neither required nor desirable. TRs should not be co-located within or otherwise share space with mechanical, electrical, or janitorial spaces. Ideally, and to the extent possible, the long wall of the TR should not be the same wall as that of an electrical room. Doors should swing out of the room (rather than into the room) in order to maximize the use of the space within the room. Fire protection, where required, can be either a wet pipe system or a dry pipe system. If it is a wet pipe system, wire cages should be installed around sprinkler heads to prevent accidental operation. TRs should be located so as to eliminate any threat of flooding.
- 2.4.2. In general, a minimum of one telecommunications room will be required on each floor, with each TR serving a radius of approximately 150 feet. A good rule of thumb is to provide one TR per 25,000 square feet, assuming that each TR is generally centered in the area it is to serve. Given this restriction as well as program restrictions that may limit the locations available to place a TR, it is possible that secondary TRs may be required. For multi-floor facilities, TRs should be stacked—this eliminates the costly and difficult-to-coordinate horizontal raceway that is required between nonstacked TRs, decreases the cost of the backbone cabling system, provides better backbone security, and eases the future maintenance burden on the owner. A primary TR should not be located on an exterior wall if avoidable.

2.4.3. Sizing

- 2.4.3.1. School Primary TR: The minimum size for a school primary TR (without co-located EF) is 9 feet by 14 feet, with walls to structure. Refer to the BIA *School Facilities Space Templates* for a typical layout of this space.
- 2.4.3.2. School Primary TR with Co-Located EF: The minimum size for a school primary TR with EF is 10 feet by 15 feet, with walls to structure, and subject to specific service provider requirements. A larger space may be required for primary TRs that are also serving as server rooms.
- 2.4.3.3. Dormitory Primary TR: The minimum size for a dormitory primary TR is 9 feet by 11 feet, with walls to structure. Refer to the BIA *School Facilities Space Templates* for a typical layout of this space.
- 2.4.3.4. Dormitory Primary TR with Co-Located EF: The minimum size for a dormitory primary TR with EF is 10 feet by 11 feet, with walls to structure, and subject to specific service provider requirements. A larger space may be required for primary TRs that are also serving as server rooms.
- 2.4.3.5. Secondary TR: The minimum size for a standard secondary TR (for both schools and dormitories) is 8 feet by 11 feet, with walls to structure. Refer to the BIA *School Facilities Space Templates* for a typical layout of this space.

2.5. Electrical Considerations

- 2.5.1. The IT Designer of Record should work with the owner to determine the projected and future expansion loads for a given TR, and provide that information to the electrical engineer for load sizing. The electrical sizing for the TR shall be based upon that load.
- 2.5.2. At a minimum, a TR shall be provided with convenience electrical receptacles on each wall, and two 20-amp dedicated duplex receptacles for each equipment rack mounted on Unistrut above the racks (e.g., a TR with three equipment racks would have six 20-amp dedicated receptacles for the racks). In addition, the primary TR shall have four dedicated 30-amp receptacles, evenly spaced above the rack locations (30-amp receptacle types will vary depending upon equipment requirements and should be coordinated with the owner prior to specification), also mounted on Unistrut. A dedicated electrical panel shall be located within and serve each TR.
- 2.5.3. Provision shall be made for additional circuits and receptacles as necessary for equipment to be mounted on the walls and/or for other equipment to be located within the room. Such equipment could consist of fire alarm panels, door control power supplies, audiovisual equipment, etc. Provision shall also be made for future electrical capacity within the room.

- 2.5.4. If a building generator and/or building UPS will be provided for the facility, one or more circuits fed from the generator and/or building UPS are to be provided in each TR.
- 2.5.5. Wall electrical receptacles shall be flush mounted with the backboard (surface-mounted electrical receptacles interfere with the mounting of horizontal ladder racking within the room and restrict the surface area available for wall-mounting communications equipment).
- 2.5.6. One or more rack-mountable UPS units shall be provided in every TR, and shall be sized based upon maximum anticipated load. The IT Designer of Record should work with the BIA to determine the sizing of the UPS unit(s).

2.6. Environmental Considerations

- 2.6.1. The IT Designer of Record should work with the BIA to determine the projected and future heat loads for a given TR, and provide that information to the mechanical engineer for heat load sizing. The cooling requirements for the TR shall be based upon that load.
- 2.6.2. Positive air pressure will be required. Temperature should be maintainable at a maximum of 75°F and humidity should range between 30 percent and 55 percent, if possible.
- 2.6.3. Independent environmental control will be required for all TRs that will house equipment with significant load potential, such as core routers and switches, Power over Ethernet (PoE) switches, computers, servers, and/or other equipment with significant power loads and/or heat output. Independent environmental control will also be required for all TRs that will house significant quantities of equipment with minor load potential—low-voltage equipment with small loads and little heat output, such as basic (no PoE) switches, etc.
- 2.6.4. Independent environmental control will not be required *only when the following conditions are met:*
 - 2.6.4.1. Equipment to be housed within the room will consist only of small quantities of equipment with minor load potential, and any other electronic equipment within the room will not add significant heat to the room.
 - 2.6.4.2. The room will not be used to house equipment with significant load potential.
 - 2.6.4.3. Provisions can be made such that cool, filtered air will be drawn into the room and hot air will be fully exhausted from the room.
 - 2.6.4.4. The environment within the room can be maintained at all times within the manufacturer-specified environmental operating parameters for all equipment to be located within the room.

13030-3. Telecommunications Rooms for Temporary/Modular Buildings

- 3.1. TRs for temporary/modular buildings do not need to satisfy the above requirements. However, they shall meet the following requirements:

3.1.1. Sizing

- 3.1.1.1. Space shall be provided within each temporary/modular facility to house an IT cabinet. The cabinet should be of adequate size to accommodate all IT connections within the temporary/modular building as well as the electronic equipment (primarily switches and a rack-mountable UPS) serving the connections.

3.1.2. Pathway

- 3.1.2.1. An underground raceway shall be provided to connect the temporary/modular facility to the main facility and/or campus raceway systems.
- 3.1.2.2. To the extent possible, conduit stubs should extend from each outlet device box to an accessible space, with a J-hook pathway available to the IT cabinet.

3.1.3. Grounding

- 3.1.3.1. The IT cabinet shall be grounded to building ground per industry standards (see Section 13060, "Communications Grounding and Bonding").

13030-4. Entrance Facility**4.1. General**

- 4.1.1. The entrance facility provides a connection point between the backbone cabling system within the building and cabling exiting the building. Communications conduits from outside the building will be terminated in the EF. The EF may also house service provider, campus, and/or other electronic equipment connected to cabling from outside the building. Generally only one EF exists per building.
- 4.1.2. If the EF is co-located within a primary TR, an additional free-standing equipment rack beyond those specified above for the school primary TR may be required. If the EF is separate from the primary TR, only one or two free-standing equipment racks will be required. Remaining space within the room should be reserved for service provider, campus, and/or other equipment connected to cabling from outside the building.

4.2. Architectural Considerations

- 4.2.1. If the EF is not co-located within a TR, the EF typically does not need to be larger than a standard TR, and can sometimes be smaller (but no smaller than 8 feet wide). If co-located within a TR, the EF may need to

be larger than a normal TR, while other architectural requirements are the same as those specified above for telecommunications rooms.

4.3. Electrical and Environmental Considerations

- 4.3.1.** Electrical and environmental requirements are the same as those specified for telecommunications rooms above, although service providers may have nonstandard requirements that the IT Designer of Record will need to coordinate with the service providers and accommodate as necessary.

13030-5. Server Room

5.1. General

- 5.1.1.** The server room provides a location for housing communications equipment such as servers, storage devices, PBX equipment, and headend equipment for other communications systems. In addition to the criteria shown in the IT Systems Selection Matrix in Section 13010, a server room will be required where the projected number of servers is eight or more, or where a facility will be serving other facilities on a campus.
- 5.1.2.** If the server room is co-located within a TR or EF, additional free-standing equipment cabinets beyond those specified above for the TR or EF may be required.

5.2. Architectural, Electrical, and Environmental Considerations

- 5.2.1.** The size of the server room, as well as the electrical and environmental requirements, will depend upon the size and quantity of the equipment to be located within the server room, plus future expansion. Server room design shall assume that all servers shall be rack-mountable. A dedicated electrical panel will be located within and serve each server room. The IT Designer of Record shall work with the owner to determine the projected and future power and heat loads for the server room, and provide that information to the electrical and mechanical engineers for heat load sizing.

5.3. Special Considerations for Communications Cabling

- 5.3.1.** For a large server room with multiple rows of equipment racks and frames, a communications cabling system *within* the room may be required. This system is similar in concept to the communications cabling serving the building at large (see Section 13040, “Communications Cabling”), albeit on a much smaller scale. The communications cabling within the server room is used for connecting equipment in that room to other equipment in the room.

13040-1. General

1.1. The communications cabling system will be the cabling system upon which most (if not all) common communications signals will be transmitted. The system shall be manufactured by an end-to-end manufacturer—i.e., the same manufacturer will produce all cabling (copper and fiber) and connectors, terminations, and terminating equipment. The contractor installing the system must be a manufacturer-backed and approved installer, able to provide the manufacturer’s extended (20-year or 25-year) application, installation, and product assurance warranties. The cabling system shall be tested by the contractor and certified by the manufacturer.

Figure 13040-1: Sample Riser Diagram

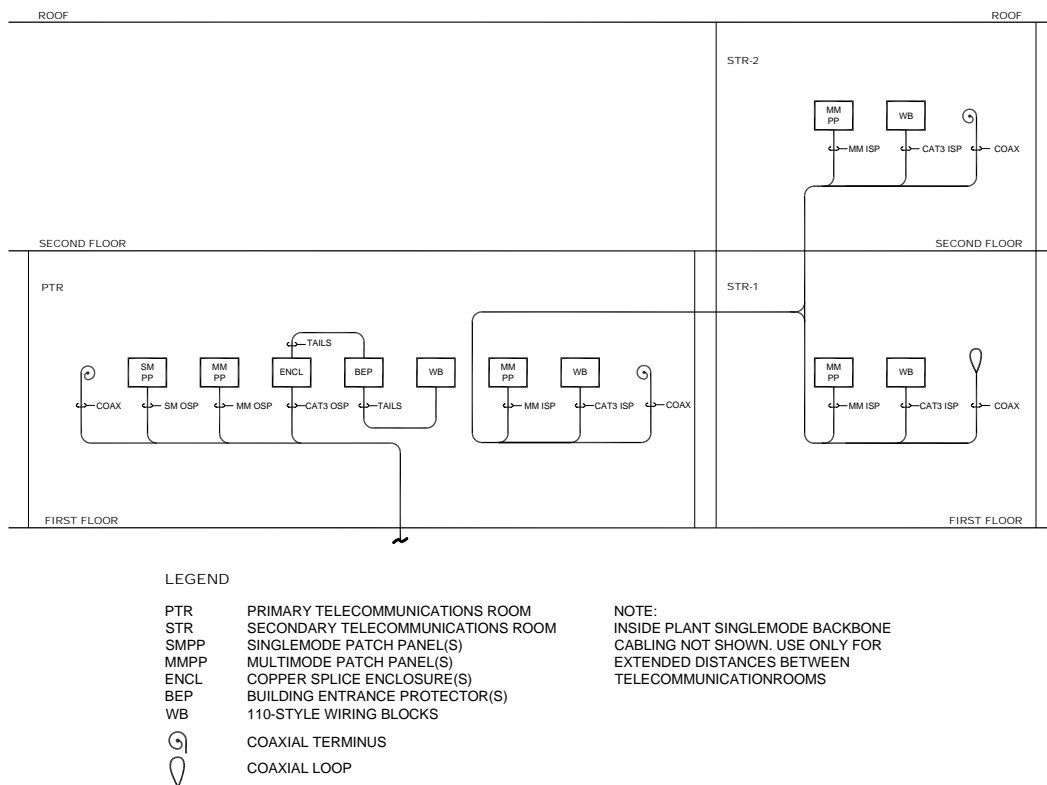

13040-2. Backbone Cabling

2.1. Inside the Building (Inside Plant)

2.1.1. *General*

2.1.1.1. Backbone cabling connects communications rooms to one another in a star topology. The backbone cabling system shall consist of multimode fiber, multipair copper, and coaxial cable (for CATV)

backbone. Large and very large schools (more than 45,000 square feet) may also have singlemode fiber backbone cable if necessary due to distance limitations of multimode fiber between telecommunications rooms (TRs); small and medium-sized schools (less than 45,000 square feet) will not typically require singlemode fiber.

Figure 13040-2: Typical Primary TR Rack Elevations

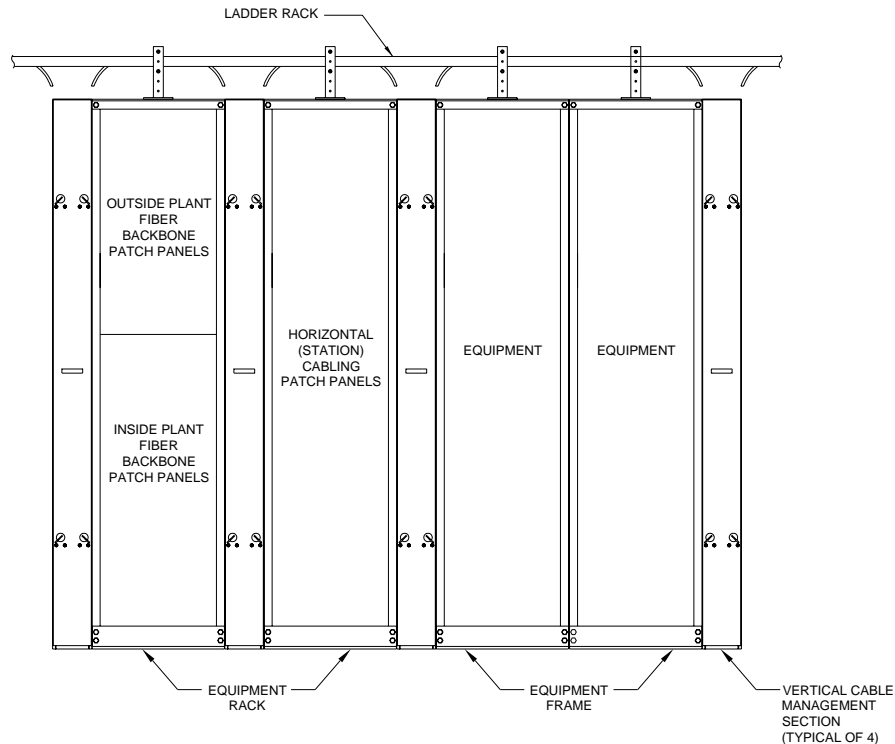

2.1.2. *Fiber Backbone Cabling*

2.1.2.1. Fiber backbone cable shall be used to distribute digital services between telecommunications rooms, the entrance facility (EF), and the server room. Fiber backbone cable shall terminate on patch panels in the equipment racks within the TRs and EF.

2.1.2.2. The minimum fiber backbone size shall be 12-strand 50/125 micron multimode (for all schools) and, if required for large and very large schools, 6-strand singlemode fiber. The IT Designer of Record shall meet with the owner to coordinate the final quantity of optical fibers required based upon site-specific requirements.

2.1.3. *Multipair Copper Backbone Cabling*

2.1.3.1. Multipair copper backbone cables shall be provided for voice/analog-grade communications. These backbone cables shall be terminated on 110-style termination (wiring) blocks in the primary

and secondary TRs and server room. The minimum copper backbone size shall be 25-pair, but shall be sized according to the number of voice-grade signals to be served.

Figure 13040-3: Typical Secondary TR Rack Elevations

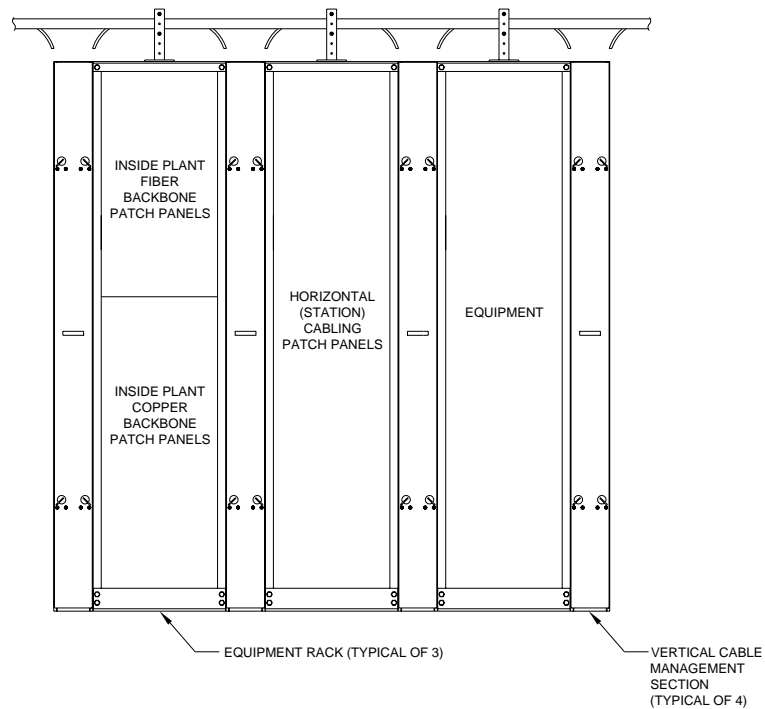

2.1.4. Coaxial Backbone Cabling

2.1.4.1. Coaxial cable shall be used to distribute CATV signals. The IT Designer of Record shall coordinate with the CATV service provider to determine coaxial termination and hardware requirements. Typical coaxial backbone cable shall be Series 11 for short distances and 0.500 hardline for greater distances (generally for larger schools).

2.2. Outside the Building (Outside Plant)

2.2.1. Outside plant (OSP) backbone cabling will connect a facility to the campus backbone, if any, or to service providers (see Section 13070, “Outside Connectivity”) if the service providers are not bringing their own cables to the facility. Campus cables will typically consist of fiber, copper, and coaxial cabling. Where campus feeds are required, each new facility should connect with a minimum of 100-pair copper feeder cable, 12-strand 50/125 micron multimode, and 6-strand singlemode fiber feeder cables. If coaxial CATV is available, coordinate with the existing cable size (typically a minimum of 0.750 hardline). The IT Designer of Record shall coordinate with the local service provider.

13040-3. Horizontal (Station/Outlet) Cabling

3.1. General

- 3.1.1. Station/outlet cabling shall consist of Category 6 cable from each outlet to the outlet's assigned TR. There shall be no differentiation between data and voice cabling and ports (i.e., a "universal" cabling system shall be designed); port utilization shall be visually defined at the patch panel by color-coded patch cords (white for voice, blue for data, yellow or green for special circuits), and if desired, at the outlet by the use of faceplate/port icons. All horizontal cabling shall be terminated sequentially on patch panels in equipment racks in the TRs.
- 3.1.2. Station cabling shall utilize the raceway/pathway system described below. Station outlets will also be provided for projectors (in the ceiling), and coordinated by the IT Designer of Record for specialized outlets requiring voice/data support (e.g., fire alarm, elevator, HVAC, wireless access points, etc.).
- 3.1.3. In general, a typical outlet will consist of two ports, and the typical wall phone will be served with one port.
- 3.1.4. A wireless network (see Section 13100, "Data Network") shall be provided for coverage throughout the facility. Station cabling shall be provided for the wireless access points required for this network.

3.2. Offices

- 3.2.1. Single-occupant offices shall be served with a minimum of two 2-port outlets (see Figure 13040-4). Cubicle areas, if present, shall each be served with one 2-port outlet).

Figure 13040-4: Typical Office Outlets

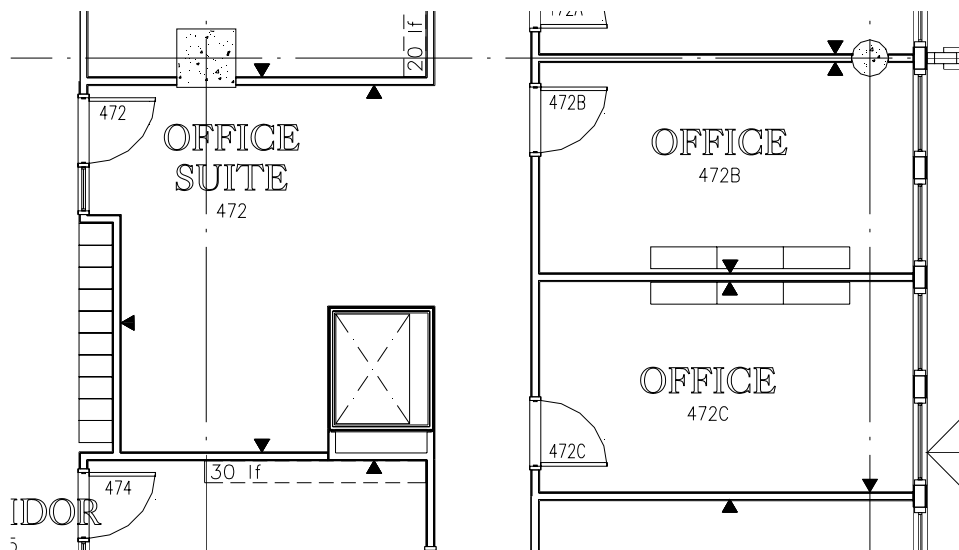

3.3. Classrooms

- 3.3.1.** Classrooms shall be served with convenience outlets on the walls and specialized outlets as required (see Figure 13040-5). In addition, each classroom shall be served with one CATV outlet consisting of one Category 6 port plus one coaxial port.

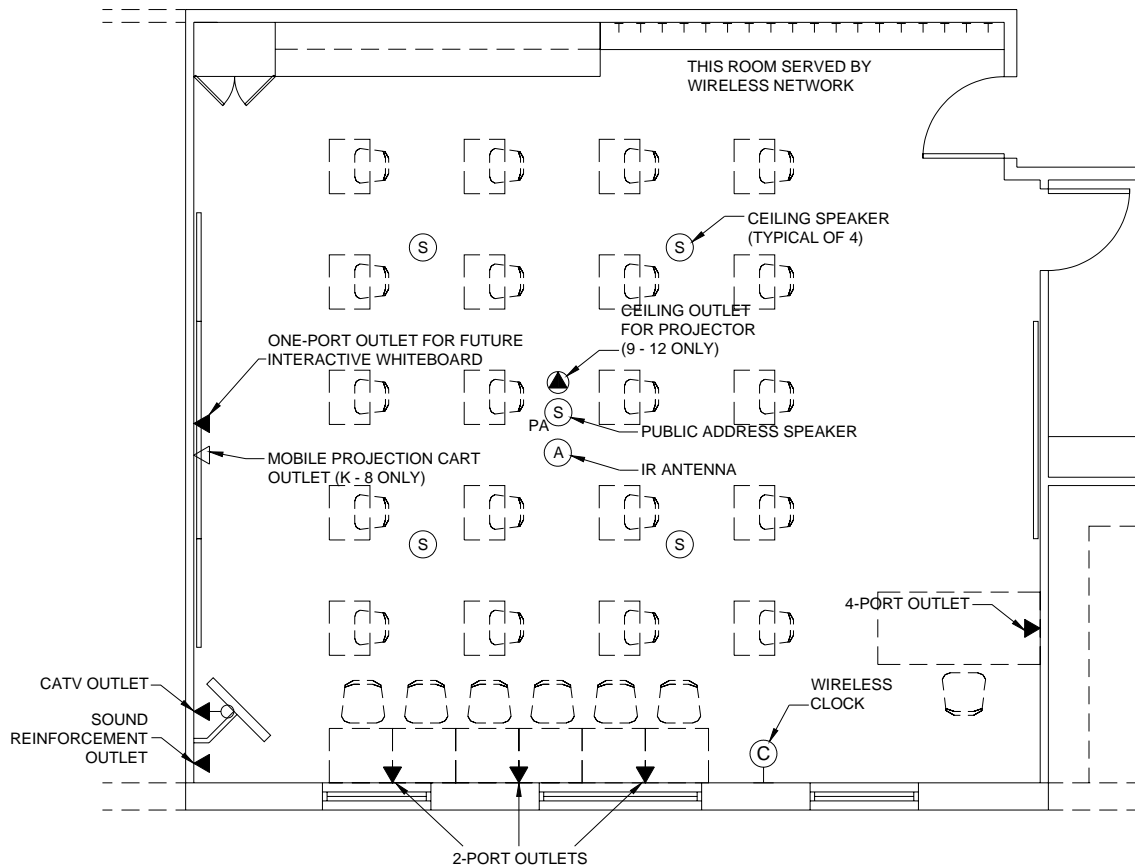
Figure 13040-5: Typical Classroom Outlets**3.4. Computer Labs**

- 3.4.1.** Computer labs and media centers (libraries) shall typically have a minimum of 20 ports for small labs and 30 to 40 ports for larger labs, as well as specialized outlets as required.
- 3.4.2.** Outlets shall be located along the perimeter walls. The use of floor boxes is discouraged, due to their propensity to fill with dirt (particularly in rural areas), pose a trip hazard, and interfere with handicapped access. However, their potential use shall be discussed and coordinated with each school project team to determine equipment layout and requirements within the computer lab.

3.5. Dormitory Rooms

3.5.1. Dormitory rooms will typically be served by one outlet containing one Category 6 port plus one coaxial (CATV) port.

3.6. Gymnasiums

3.6.1. Gymnasiums shall be served with a minimum of two 2-port outlets for wireless access points.

13040-4. Labeling Scheme

4.1. An identification and administration system shall be employed to identify and label communications infrastructure, including passive equipment (copper, fiber, and coaxial cables, termination hardware, equipment rack/frames/cabinets, etc.). Labels shall be unique, machine-generated, and permanent. The labeling/identification system shall conform to the TIA/EIA-606 standard and comply with the BIA's Office of Indian Education Program (OIEP) requirements. The IT Designer of Record shall coordinate the final labeling scheme with the owner.

13050-1. General

- 1.1. Like communications rooms, a properly designed and sized communications pathway system is critical to a facility's ability to accommodate future technological change, particularly with regard to its support of the communications cabling system.

13050-2. Conduit to Accessible Ceiling Space

- 2.1. The cable pathway serving the outlets within the facility shall consist of 1-inch (minimum) conduit raceway (with bushing) from the outlet device box to accessible ceiling space. Each device box shall have a dedicated conduit to the ceiling (i.e., "daisy chaining" of device boxes is not acceptable).
- 2.2. The pathway shall consist of J-hooks from the end of the conduit to the telecommunications room (TR) for schools of less than 45,000 square feet, or J-hooks to cable tray to the TR for schools larger than 45,000 square feet.
- 2.3. J-hooks will typically provide the cable path in dormitories from the end of the conduit to the TR.
- 2.4. Conduit segments between end points/pull boxes shall not exceed 100 feet, nor contain more than two 90-degree bends. The use of flexible conduit and condulets is not acceptable in new facilities.

13050-3. Cable Tray

- 3.1. The cable tray system shall be the primary raceway serving the communications cabling within medium to large facilities (less than 45,000 square feet). In general, each floor will be equipped with cable tray, and the cable tray will generally be routed in common areas (such as hallways) to facilitate access and maintenance. Cable trays shall be wire-basket type to minimize cost. Where cable tray is required to pass through smoke- and fire-rated barriers, the cable tray shall transition to fire-stopping pathway devices through the barrier and back to cable tray on the other side. Cable tray may penetrate nonrated barriers.
- 3.2. Fire alarm and other low-voltage systems running on proprietary cabling shall not be placed within this cable tray. Such systems shall have their own raceway/pathway, although in some cases it is permissible to hang the cabling for these systems beneath the cable tray.

Figure 13050-1: Typical Communications Pathway System for Medium to Large Buildings

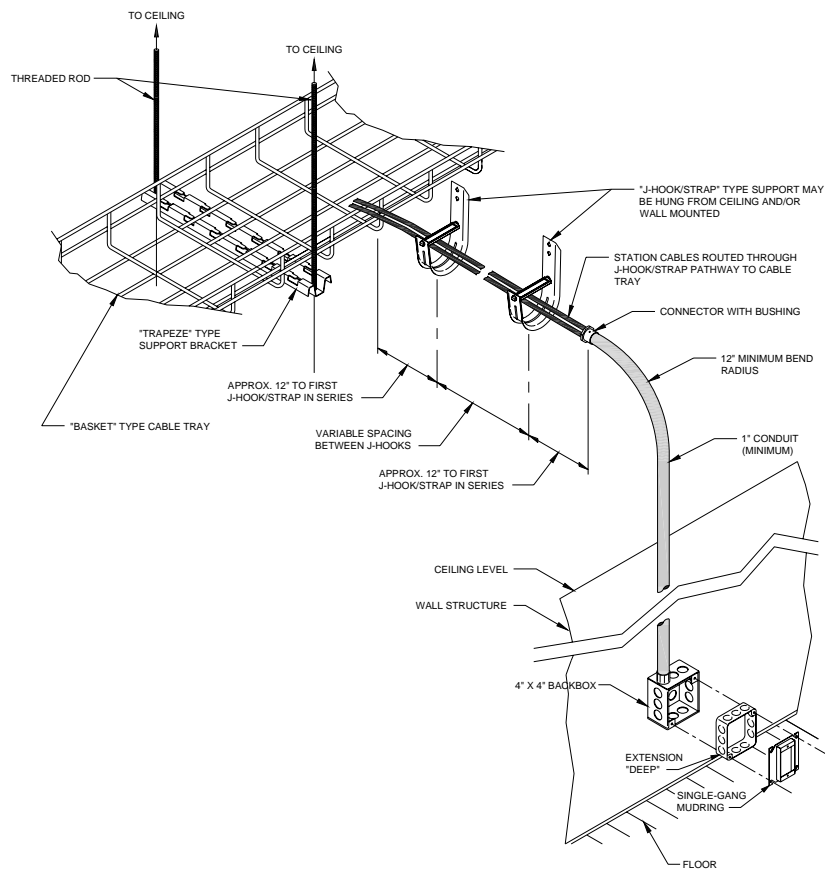

13050-4. Sleeves

- 4.1. For multi-floor facilities, a minimum of four 4-inch conduit sleeves shall connect the TR to the TR(s) above and/or below. For TRs with a higher concentration of cable, additional sleeves will be required. The entrance facility (EF) will be connected to the TRs either through sleeves or through raceway (if the EF is separate from the TR). For the EF, the quantity of sleeves and/or raceway is dependent upon the amount of backbone cabling leaving the EF.
- 4.2. One 2-inch conduit shall provide a cable path from a TR to the roof for future services/equipment (e.g., antenna, etc.).

13050-5. Fire-Stopping Pathway Devices

- 5.1. Fire-stopping pathway devices (e.g., EZ-Path, FlameStopper, etc.) are the preferred pathway through smoke- or fire-rated structures and shall provide a code-compliant pathway for communications cabling through smoke- or fire-rated barriers. Fire-stopping pathway devices shall be provided in quantities equal to the volume of the usable volume of the pathway (such as cable tray) it serves.

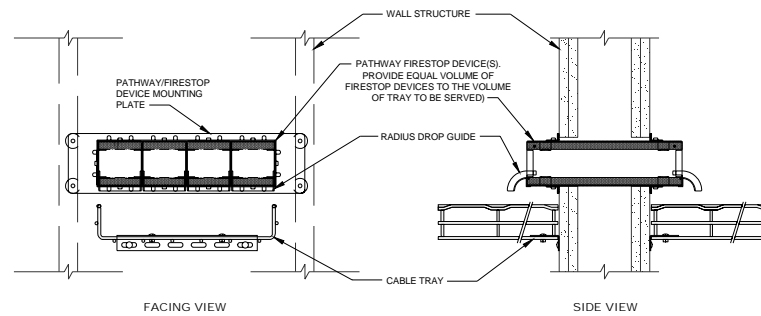
Figure 13050-2: Fire-Stopping Pathway Device**13050-6. Device Boxes**

- 6.1.** Outlet devices boxes shall be 4-inch by 4-inch, deep style, with single-gang (2-inch-by-4-inch) extension rings. Surface raceway (such as Wiremold) shall be avoided to the extent possible in new facilities, but may be provided where no other option is available.

13050-7. Floor Boxes and Poke-Through Devices

- 7.1.** The use of floor box and/or poke-through devices shall be avoided to the extent possible, but may be provided where no other option is available. These devices will typically share space with power and shall be flush-mounted. Conduits feeding these devices shall be fed underslab (for slab-on-grade installations) or fed from the ceiling space of the floor below.

13050-8. Outside Plant Pathways

- 8.1.** Communications conduits from outside the building will enter the EF. These conduits shall consist of a minimum of four 4-inch conduits (minimum one spare) from a communications vault (placed in a strategic location) outside the facility. The vault is necessary to provide for future access to the duct bank coming into the facility, and to more easily accommodate future facilities on the site, such as modular buildings. From this vault, a minimum of two 4-inch conduits shall be installed to the location of the utility (telephone, data, etc.) on the site.
- 8.2.** Underground conduits that may be damaged (due to dig-ups, shallow depth, placement below roads, etc.) shall be encased in concrete.

THIS PAGE INTENTIONALLY LEFT BLANK

13060-1. Industry-Standard Telecommunications Grounding and Bonding System

- 1.1. An industry-standard telecommunications grounding system shall connect all telecommunications spaces and the racks and raceway equipment within them to the building ground. The primary telecommunications room (TR) will be equipped with a telecommunications main grounding busbar (TMGB), and the other TRs will be equipped with telecommunications grounding busbars (TGBs). The busbars will be interconnected with grounding wire, sized per BICSI's *Telecommunications Distribution Methods Manual*, and connected to the building ground.

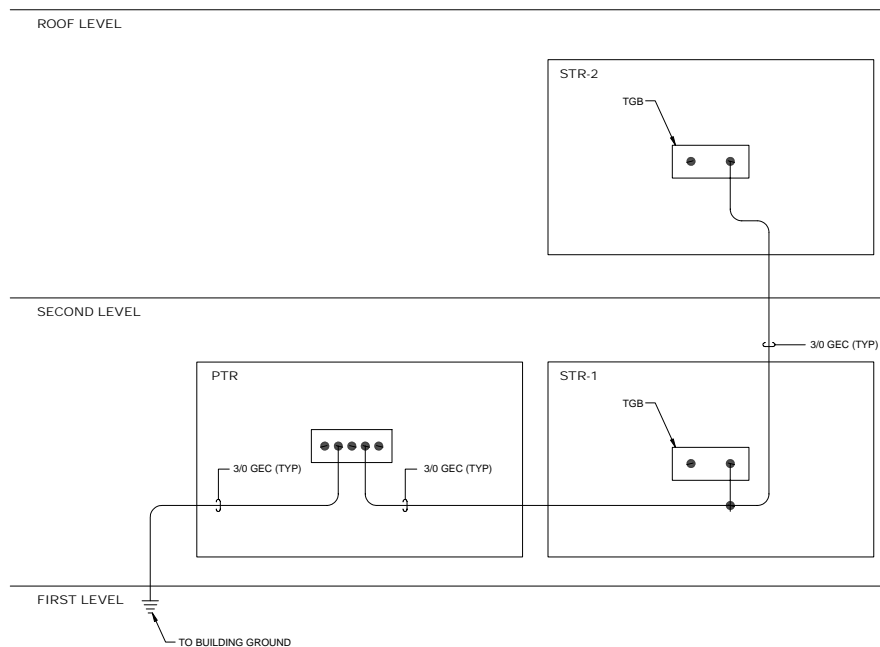
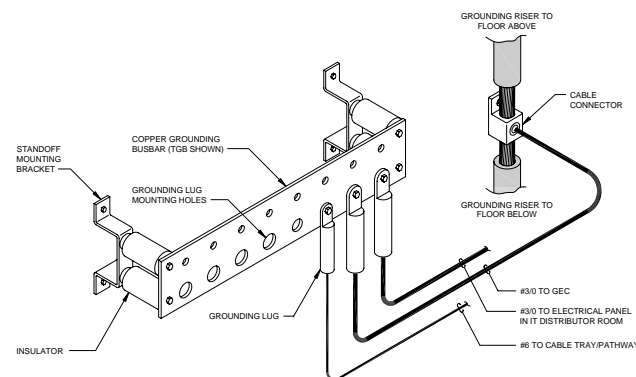
Figure 13060-1: Typical Grounding/Bonding Riser Diagram**Figure 13060-2: Typical Grounding Busbar**

THIS PAGE INTENTIONALLY LEFT BLANK

13070-1. General

- 1.1. The IT Designer of Record shall work with the owner to determine the best option(s) for voice, data, and CATV connectivity for a given facility. Initial cost, ongoing cost, reliability, and speed shall all be considered. It is possible that multiple services may be provided by a single service provider.
- 1.2. The IT Designer of Record shall coordinate with the local service provider to ensure that any service provider requirements for power, ducts, spaces, etc., are addressed in the IT design.
- 1.3. The IT Designer of Record shall prepare and provide a report on the availability of communications at the project site, and an analysis of what will be required to provide communications to the site.
- 1.4. Refer to Chapter 5, "Civil," and Chapter 11, "Electrical," for additional information and requirements.

13070-2. Voice Connectivity

- 2.1. Voice connectivity (dial tone) shall be provided by a local service provider.

13070-3. Data (Internet) Connectivity

- 3.1. The primary data requirement for outside connectivity is Internet access, which is a mandatory requirement for all new facilities. Internet access can be provided by various means:
 - 3.1.1. *T1*. If T1 service is available, it shall be the preferred means for Internet access.
 - 3.1.2. *Satellite*. This is the least desirable option, but in some cases may be the only one available.

13070-4. Cable Television (CATV) Connectivity

- 4.1. CATV, where available, shall be provided by a local service provider. The local service provider should also be tasked with providing headend equipment for modulating/demodulating and/or amplifying their signals as necessary within the facility.

13070-5. Design

- 5.1. The IT Designer of Record shall work with the owner to determine the requirements for these systems and then forward the information to the owner and the BIA for action, as required.

THIS PAGE INTENTIONALLY LEFT BLANK

13080-1. Access Control System

1.1. There are two types of access control: keyed access and card access. Keyed access is the simplest, the most familiar, and the least costly; card access offers many benefits over keyed access, but is more costly and requires more training.

1.2. Keyed Access

1.2.1. The keyed access system is the simplest form of access control. Initial costs are low, but maintenance can be costly and inconvenient if locks must be refitted due to lost or stolen keys. Regardless, all doors in BIA school facilities that require control shall be keyed, even if a door will also use card access.

1.3. Card Access

1.3.1. The card access control system has a higher initial cost. However, benefits of a card access control system include the storage of historical entryway activity (i.e., who entered what door when); real-time monitoring of entryways; and where keys are not also required, the virtual elimination of mechanical key distribution and lock changing. In addition, motion and glass-break sensing devices can be incorporated into this system to provide for intrusion detection.

1.3.2. Because card access control systems can be costly and will require more staff training than would a keyed system, card access systems should be deployed only in schools in which there is a demonstrated need for them. The IT Designer of Record shall meet with the owner to make this determination.

1.3.3. **General Requirements.** A card access control system will require 4 feet by 8 feet of wall space within a telecommunications room (TR), a 120-volt AC circuit, and cable pathway from the TR to device locations. Entryways can be controlled and monitored as follows:

1.3.3.1. *Controlled:* Controlled entryways shall have an electronic locking system, card readers/keypads, door position switches, and shall provide free egress from the facility or room at all times. The access control system shall maintain a secure door at all times outside of scheduled building operation or authorized entry of personnel (valid card/code entry).

1.3.3.2. *Monitored:* Monitored entryways shall have door position switches that indicate when a door has been opened or has been held open for too long.

1.3.3.3. Raceway for controlled doors will be necessary. See Figure 13080-1 for raceway requirements.

Figure 13080-1: Typical Raceway for a Controlled Door

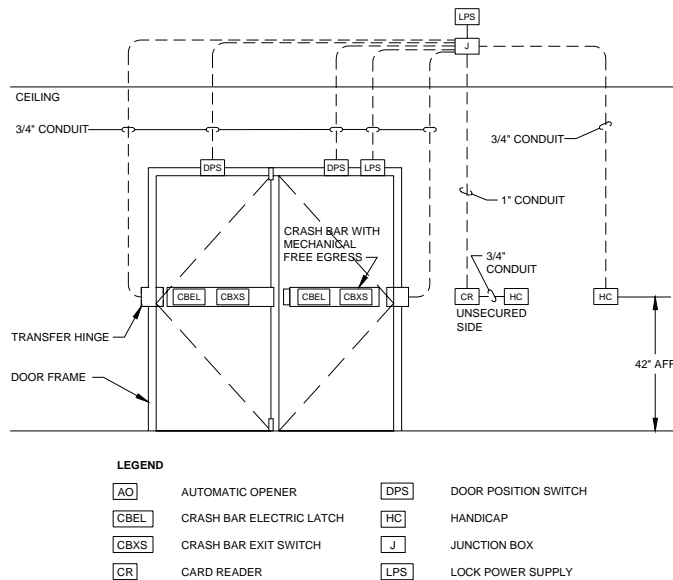

1.3.4. Specific School Requirements

1.3.4.1. K–6, K–8, and Associated Dormitories

- *Interior doors*
 - Access control not required
- *Exterior doors*
 - Public entryways: Controlled
 - Nonpublic entryways: Monitored

1.3.4.2. K–12, 9–12, and Associated Dormitories

- *Interior doors*
 - Equipment room, media center, server room, and computer labs: Controlled
- *Exterior doors*
 - Public entryways: Controlled
 - Nonpublic entryways: Monitored

13080-2. Video Surveillance System (Camera System)

2.1. The primary function of a video surveillance system is to monitor and/or record events at specified locations throughout the facility. A video surveillance system monitors sensitive areas for better facility security and is capable of recording camera images to a storage device. Cameras should be vandal proof,

and either fixed or with pan-tilt-zoom (PTZ) capability, depending upon the application.

- 2.2. The system should be Internet Protocol (IP) based, enabling it to transmit video on the communications cabling system specified in Section 13040; use the data network for communications; and provide for Power over Ethernet functionality so that cameras will not require a separate electrical outlet (except for PTZ cameras). Such a system can be less costly and easier to maintain than older analog-based systems. Additionally, while sophisticated monitoring software may be used, an IP-based system typically provides functionality for “quick viewing”—with proper security restrictions in place, each camera image can be viewed by using a standard web browser, and the digital viewing software and stored images can be made remotely accessible via the data network and the Internet.
- 2.3. Video surveillance systems will be required in varying degrees at all schools. In very general terms, small schools may require approximately 10 to 12 cameras; medium-sized schools may require approximately 10 to 20 cameras, and large schools may require 30 or more cameras. Recording of the video images, however, is not necessary at all schools; it will only be necessary where there is a demonstrated need (i.e., special case justification). The IT Designer of Record should work with the owner to determine if there is a need for recording of video images.
- 2.4. Even if there is no immediate need for remote monitoring or recording of video images, the system should be capable of providing these functions.
 - 2.4.1. **General Requirements.** The video surveillance system will require four rack spaces within a TR, a 120-volt AC circuit, and cable pathway from the TR to device locations.

Figure 13080-2: Video Surveillance System Diagram

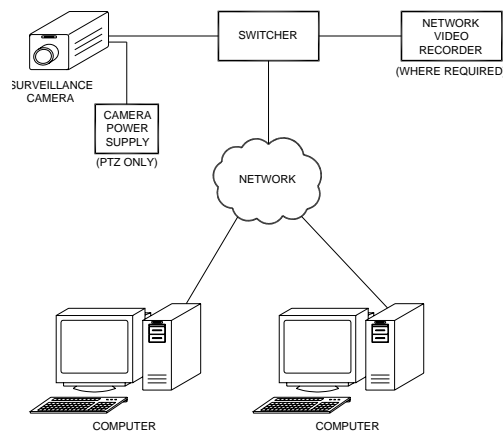

2.4.2. *Specific School Requirements*

2.4.2.1. K–6, K–8, 7–8, and Associated Dormitories

- Public entryways: Fixed
- Playground areas: PTZ
- Parking areas: PTZ
- Bus pickup/drop-off areas: Fixed
- Public areas: Not monitored
- Corridors: Not monitored

2.4.2.2. K–12, 9–12, and Associated Dormitories

- Public entryways: Fixed
- Playground areas: n/a
- Parking areas: PTZ
- Bus pickup/drop-off areas: Fixed
- Public areas: Fixed
- Corridors: Fixed

13080-3. **Intrusion Detection System**

- 3.1. The intrusion detection system monitors critical areas within the facility for motion or for unexpected sounds (such as glass breaking). Upon detection, the system will sound an audible alarm and notify authorities.
- 3.2. The intrusion detection system can be an integral part of an existing card access control system or be a stand-alone system in facilities without a card access control system. Intrusion detection devices used with a card access control system will record events to the system database, whereas a stand-alone intrusion detection system is simpler and does not typically record events.

3.3. **General Requirements**

- 3.3.1. The intrusion detection system will require 4 feet by 4 feet of wall space within a TR, a 120-volt AC circuit, and cable pathway from the TR to device locations.

3.4. **Specific Requirements**

- 3.4.1. Areas to be monitored include entryways, corridors, and rooms with significant and/or costly equipment, such as computer labs, server rooms, media centers, and equipment storage areas.
- 3.5. While stand-alone intrusion detection systems are relatively low cost, it should be noted that they are not particularly effective at catching suspicious activity in progress unless they are combined with other security systems. They can serve as a deterrent, however. With this in mind, a stand-alone system should be

placed in facilities where there is a demonstrated need (i.e., special case justification), and in particular, for those facilities that will have limited access control. The IT Designer of Record should work with the owner to determine if such a system is necessary, and if so, determine the specific requirements.

13080-4. Metal Detection System

- 4.1. Metal detection systems are typically not required, unless there is a demonstrated need for them. The IT Designer of Record should work with the owner to determine if such a system is necessary.

THIS PAGE INTENTIONALLY LEFT BLANK

13090-1. General

- 1.1. Room (classroom) technologies can include such systems as sound reinforcement, video projection, screens/display devices, and other equipment. The use of these technologies within the classroom is very dependent upon the nature of the instruction or presentation, the instructional style of the teacher, training, and ease of use. Different rooms and spaces will require different equipment.

13090-2. Sound Reinforcement System

- 2.1. A sound reinforcement system is used to distribute a presenter's spoken words to an audience area and/or to provide sound distribution for a presentation or video. Assistive listening systems compliant to ADAABAAG shall be installed at spaces where audio amplification is provided.
- 2.2. It is becoming increasingly common to find sound reinforcement installed in classrooms of all grades; consequently, it is required for classrooms in all BIA schools. Additionally, any room with a permanently installed video projection system should also be equipped with sound reinforcement.
- 2.3. **General Requirements.** The sound reinforcement system requires an equipment mounting location, a 120-volt AC circuit, and cable pathway to device locations, all local to the room that it serves. A volume control for the sound reinforcement system will be wall mounted in a location convenient to the instructor.
- 2.4. **Specific Requirements**
 - 2.4.1. *Classrooms.* The sound reinforcement system should include a wireless microphone system, one line-level connection port located near the presentation area, an amplifier, and an appropriate number of ceiling-mounted loudspeakers.
 - 2.4.2. *Gymnasium/Theater.* The sound reinforcement system should include a microphone (wired and wireless) system, one microphone-level and two line-level connection ports located at the presentation area, multiple microphone and line-level ports throughout, a mixer system, a playback system for program material, an amplification system, and an appropriate number of directional loudspeakers suspended from the ceiling. The public address system in the gymnasium shall be distributed, utilizing the gymnasium sound reinforcement system via a line-level output from the public address system headend equipment.

13090-3. Video Projection System

- 3.1. Video projection provides presentation capabilities and reinforcement of video material to the students or to an audience. A video projection system consists of mobile or permanently installed video projectors and projection surfaces.

3.2. Specific Requirements

- 3.2.1. *K–6 Classrooms.*** Classrooms will share mobile projection systems (see below). Nonglare whiteboards (see below) will be used in each classroom for projection surfaces. A permanent video projection system will not be required, although one LCD TV on a swing-arm assembly should be provided for each K–6 classroom.
- 3.2.2. *7–12 Classrooms.*** Classrooms will be equipped with permanently installed projection systems (see below) and nonglare whiteboards (see below) for projection surfaces.
- 3.2.3. *Gymnasiums and Theaters.*** Gymnasiums and theaters will be equipped with shared mobile projection systems (see below) and portable screen (see below) projection surfaces.

3.3. Mobile Video Projection System

- 3.3.1.** A mobile projection system consists of a moveable cart with an LCD projector, a DVD/VCR player, appropriate connection cables, and an amplifier with speakers if there is no sound reinforcement in the room in which the cart is to be used. One or more mobile systems shall be provided for shared use among classrooms and spaces without permanently installed video projection systems. Handheld remote control shall be provided with each mobile system.

3.4. Permanent Video Projection System

- 3.4.1.** A permanently installed projection system consists of a ceiling-mounted video projector with support hangers, a video switcher, a DVD/VCR player, connection cables for source devices (such as computers, DVD/VCR players, and/or TV signals), and connectivity to sound reinforcement. Handheld remote control shall be provided with each permanently installed system.

Figure 13090-1: Ceiling-Mounted Video Projector

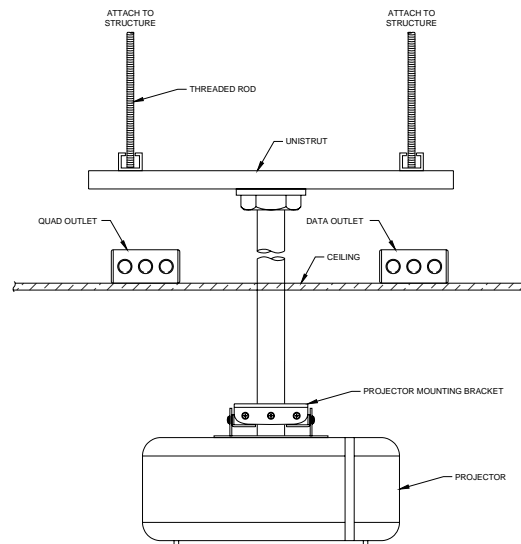

3.5. Projection Surfaces

- 3.5.1. *Nonglare Whiteboards.*** Nonglare whiteboards are increasingly being designed to serve as projection surfaces, in addition to serving as traditional markup surfaces. With this in mind, these whiteboards shall be provided in lieu of standard manual or automatic (drop-down) projection screens. Whiteboards are easy to use, decrease the technology maintenance burden within the classroom, and provide for a clean and simple aesthetic. A standard 4-foot-by-6-foot whiteboard provides a projected image size optimal for data presentation to students seated up to 25 feet away from the whiteboard.
- 3.5.2. *Portable Screens.*** Portable projection screens shall be provided for public spaces such as gymnasiums and theaters.
- 3.5.3. *Motorized Screens.*** Motorized screens shall be provided for large, formal presentations. Such spaces will be defined on a case-by-case basis. The IT Designer of Record shall work with the owner to determine the requirements, if any.
- 3.5.4. *Interactive Whiteboard (Smart Board).*** Interactive whiteboards are equipped with a touch-sensitive display that connects to a computer and a digital projector to show a computer image. Using an interactive whiteboard, the instructor can control computer applications directly from the display, write notes in digital ink, and save the work for later use.
- 3.5.4.1.** Interactive whiteboards are not required. However, infrastructure (pathway and cabling) should be provided to support interactive whiteboards in the future.

13090-4. Distance Learning System

- 4.1. The primary function of the distance learning (DL) system is to provide real-time audiovisual communications between two sites for the purpose of collaboration.
- 4.2. The standard DL system for BIA schools is essentially a mobile cart-based videoconferencing system. Each DL cart is equipped with microphones, one video codec, one digital signal processor, one camera, one 42-inch flat-panel display, loudspeakers, and a control system. The DL system cart will require power and data connections within each room of use.
- 4.3. **Specific Requirements**
 - 4.3.1. *9–12 Schools.* Provide one DL cart per school.

13100-1. General

- 1.1. The data network shall be a complete, operable and scalable Internet Protocol (IP)-based wired network delivering seamless Ethernet connectivity throughout the building. Data network switches shall be Power over Ethernet (PoE) capable, in order to support wireless access points and Voice over Internet Protocol (VoIP) telephones.
- 1.2. Hardware components shall be of the same manufacturer throughout the entire building. The data network shall fully integrate with the VoIP telephone system.
- 1.3. In addition to the data network discussed above, a wireless data network shall be installed throughout the building. Users shall be able to connect wirelessly to the network, authenticate and establish an encrypted session seamlessly, and be able to use the network without service interruption throughout the facility. Wherever possible, wireless access points should be placed in locations easy to access at all times (i.e., hallways are preferable to classrooms).

13100-2. Design

- 2.1. The IT Designer of Record shall work with the owner to determine the requirements for this system and then forward the information to the BIA, who will in turn provide the information to the BIA-approved (i.e., E-rate) data network system designer for final design. The system shall be installed by a BIA-approved integrator.

THIS PAGE INTENTIONALLY LEFT BLANK

13110-1. General

- 1.1. The telephone system shall be a Voice over Internet Protocol (VoIP) digital system (it will make use of the communications cable system and the data network for communications). The IT Designer of Record shall work with the owner to determine the quantity of incoming lines for a specific site, based upon projected staff requirements. The capacity of stations/phones supported shall be sized to support the initial requirement plus future expansion. This system shall provide one main number for general incoming calls, with individual direct-dial numbers for each designated user.
- 1.2. Hardware components shall be of the same manufacturer throughout the entire building(s). The telephone/intercom system shall fully integrate with the data network system.
- 1.3. The phone system shall support conference calls with at least four other participants (internal or external), and will provide direct intercom connectivity between phones (except for student phones in dormitories).
- 1.4. All desk and classroom phones shall have a built-in speakerphone and support at least two call appearances. Phones will make use of the standard communications cabling system.
- 1.5. The telephone system shall include a voice mail system with auto attendant capabilities. Each designated user will have an individual voice mailbox, and incoming messages will activate a “message waiting” light at the user’s telephone.
- 1.6. Telephone service shall be available in all classrooms, offices, media centers, teacher preparation areas, conference rooms, and secretarial areas. At least one pay phone shall be available per facility.
- 1.7. The telephone system installation and its elements shall comply with the Americans with Disabilities Act and Architectural Barriers Act Accessibility Guidelines (ADAABAAG), as well as with applicable federal, local, and FCC requirements.

13110-2. Design

- 2.1. The IT Designer of Record shall work with the owner to determine the requirements for this system and then forward the information to the BIA, who will in turn provide the information to the BIA-approved (i.e., E-rate) telephone system designer for final design. The system shall be installed by a BIA-approved integrator.

THIS PAGE INTENTIONALLY LEFT BLANK

13120-1. Public Address/Bell Parameters

- 1.1. The primary function of the public address (PA) and bell system is to broadcast spoken word messages originating from any standard phone handset. Messages shall be broadcast to any specific loudspeaker zone or to all loudspeaker zones. The secondary function is to broadcast audible tones (i.e., the bell) throughout the building.
- 1.2. The PA system shall include a telephone interface, a system processor, a zone selection module, a tone generator, an amplifier, and loudspeakers as required in areas without a telephone handset.
- 1.3. The PA system shall broadcast scheduled tones (e.g., “bell” tones, etc.) to signify specific events. The IT Designer of Record shall coordinate with the owner to determine specific tone schedules.
- 1.4. The PA system announcement in gymnasiums will be distributed utilizing the gymnasium sound reinforcement system. A line-level output from the PA headend equipment to the gymnasium sound reinforcement system shall be required.
- 1.5. The PA system will reside within the telecommunications room (TR) and will require a 3-foot-by-3-foot section of wall space, a 120-volt AC circuit, and cable pathway from the TR to each device within the facility.
- 1.6. The PA system, where applicable, shall include zones to serve the campus and/or outside areas as necessary.

13120-2. Integration

- 2.1. The PA system shall fully integrate with the “bell” system and the telephone system.

THIS PAGE INTENTIONALLY LEFT BLANK

13130-1. Clock System Parameters

- 1.1. The clock system shall be capable of receiving atomic time signals broadcast from the U.S. or English atomic clocks. The clock system shall be wireless, shall continually synchronize clocks throughout the facility, and shall be capable of clock readouts in multiple time zones where desired. Clocks shall automatically adjust for Daylight Saving Time (even after power outages), eliminating maintenance.

THIS PAGE INTENTIONALLY LEFT BLANK

13140-1. Radio System Parameters

- 1.1. A radio system may be required to provide communication with mobile users (bus, etc.). The IT Designer of Record shall work with the owner to determine if such a system is required, and provide a radio system design as necessary.

THIS PAGE INTENTIONALLY LEFT BLANK

13150-1. Training Parameters

- 1.1. The IT Designer of Record shall specify that the installation contractor(s) will provide training on the proper operation and routine maintenance of the various IT systems. Training shall be on-site and include hands-on demonstrations. The instructor shall be a qualified and experienced trainer. Training shall not commence until the system(s) are complete, tested, and fully operational.

13150-2. Operations and Maintenance Manual

- 2.1. The IT Designer of Record shall require that the operations and maintenance manual (to be provided by the contractor(s)) be used as the primary training aid. The contractor shall schedule, arrange for, and provide equipment and personnel to professionally videotape the training session(s), and shall provide the subsequent recording to the owner in both VHS and DVD formats.

THIS PAGE INTENTIONALLY LEFT BLANK

14000-1. Introduction

- 1.1. This chapter shall be used as a guideline in the development of the food service kitchens within all new BIA school facilities. The specific layout of food service kitchens is the responsibility of the Designer of Record. This chapter provides general planning relationship information as well as functional requirements for kitchens. Kitchen design shall be in conformance with these guidelines unless exceptions to them are granted by the BIA.
- 1.2. Refer to Chapter 1, “General Information,” and Chapter 2, “Presentation of Data,” for required documents, drawing and specifications formats, and other design and submittal requirements not discussed in this chapter.
- 1.3. Additional design and submittal requirements may apply for projects with unusual or highly technical criteria.
- 1.4. As applicable, the Designer of Record shall incorporate the sustainability strategies identified in Chapter 3, “LEED Goals and Guidelines.”
- 1.5. The guidelines in this chapter should be used in conjunction with those in the other chapters in this handbook, and the Designer of Record should coordinate with the other project consultants to be sure all aspects of the school facility are effective and compatible.
- 1.6. All design features must be weighed carefully for their initial cost, long-term maintenance cost and needs, durability, and their impact on the environment.

THIS PAGE INTENTIONALLY LEFT BLANK

14010-1. General

1.1. Specific program requirements of the food service kitchen shall be determined on a project-by-project basis but shall include the following considerations:

- Number of meals served per day
- Age of students served
- Types of meal choices to be provided
- Type(s) of serving counters to be used
- Storage capacity of kitchen in relationship to delivery schedule

THIS PAGE INTENTIONALLY LEFT BLANK

14020-1. General

- 1.1. For kitchen design, follow all applicable current codes, standards, and laws. For a more general list of codes and standards that apply to BIA educational facilities, refer to Chapter 1, “General Information.” During design, report any required deviations from codes and standards to the Contracting Officer.
- 1.2. Where two codes, standards, or laws are applicable to the topic under review, use the more conservative or more stringent. Consult with the BIA Office of Facilities Management and Construction (OFMC) to resolve any questions or conflicts regarding application of codes and standards.
- 1.3. Ensure that all commercial kitchens conform to the guidelines set forth in the latest edition of the U.S. Public Health Service’s (PHS) *Food Service Sanitation Manual*. The BIA is to provide additional input from the Indian Health Service on kitchen design requirements and water systems.

14020-2. Applicable Codes and Standards

- 2.1. The design criteria shall comply with the guidelines published by or contained in the following:
 - **Air-Conditioning and Refrigeration Institute (ARI):** Applicable regulations and standards for remote refrigeration systems, components, and installation.
 - **American Gas Association (AGA):** Standards for gas-heated equipment. Automatic safety pilots to be provided on all equipment, where available. (Canadian Gas Association or alternate testing lab’s seals will be accepted if allowed by local code jurisdictions.)
 - **American National Standards Institute (ANSI):**
 - Standards A40.4 Air Gaps in Plumbing Systems and A40.6 Backflow Preventers in Plumbing Systems for water connection air gaps and vacuum breakers.
 - Standard B57.1 Compressed Gas Cylinder Valve Outlet and Inlet Connections for compressed-gas cylinder connections, and with applicable standards of the Compressed Gas Association (CGA) for compressed-gas piping.
 - Z21 series standards for gas-burning equipment. Provide labels indicating the name of the testing agency.
 - **American Society of Heating, Refrigerating and Air-Conditioning Engineers (ASHRAE):** Applicable regulations and standards for remote refrigeration systems, components, and installation.
 - **American Society of Mechanical Engineers (ASME):** Boiler code requirements for steam-generating and steam-heated equipment.

- **American Society for Testing and Materials (ASTM):** C1036 Standard Specification for Flat Glass and C1048 Standard Specification for Heat-Treated Flat Glass—Kind HS, Kind FT Coated and Uncoated Glass.
- **American Welding Society (AWS):** D1.1 Design of Welded Connections.
- **Americans with Disabilities Act and Architectural Barriers Act Accessibility Guidelines (ADAABAAG):** Requirements as applicable to the project.
- **The Montreal Protocol:** All refrigerants used for any purpose are to comply with the 1995 requirements of the Montreal Protocol, including subsequent revisions and amendments. No CFC refrigerants will be permitted on any BIA project.
- **National Electrical Code (NEC):** NFPA requirements for electrical wiring and devices included with food service equipment, ANSI C2 and C73, and applicable National Electrical Manufacturers Association (NEMA) and National Electrical Contractors Association (NECA) standards. All the commercial kitchen equipment should have UL (for electrical/ventilators), AGA (for gas), and NSF (for sanitation) labels. There are a number of items on the market missing one or more of these labels that can cause serious problems for the owner or architect if they are specified or approved as alternates.
- **National Electrical Manufacturers Association (NEMA):** Standard LD3 High-Pressure Decorative Laminates, Annex A: Application, Fabrication, and Installation.
- **National Fire Protection Association (NFPA):** Applicable sections for exhaust hoods, ventilators, duct and fan materials, hood fire suppression systems, and construction and installation.
- **National Sanitation Foundation (NSF):** Latest standards and revisions. Provide NSF seal of approval on each applicable item. (UL sanitation approval and seal accepted if allowed by local code jurisdictions.)
- **Refrigeration Service Engineers Society (RSES):** Applicable regulations and standards for remote refrigeration systems, components, and installation.
- **Sheet Metal and Air Conditioning Contractors' National Association (SMACNA):** Latest edition of guidelines for seismic restraint of kitchen equipment, as applicable to project location.
- **Underwriters Laboratories (UL):** Standards as applicable for electrical components and assemblies. Also, UL 300 Fire Testing of Fire Extinguishing Systems for Protection of Commercial Cooking

Equipment, for wet chemical fire suppression systems for exhaust hoods/ventilators.

14020-3. Personnel Qualifications

- 3.1.** All refrigeration components installation, repairs, and/or associated work on any refrigeration system are to be performed by a certified refrigeration mechanic.

THIS PAGE INTENTIONALLY LEFT BLANK

14030-1. Kitchen Work Flow

- 1.1. The following diagram displays the work flow in a typical school commercial kitchen.

Figure 14030-1: Work Flow Diagram

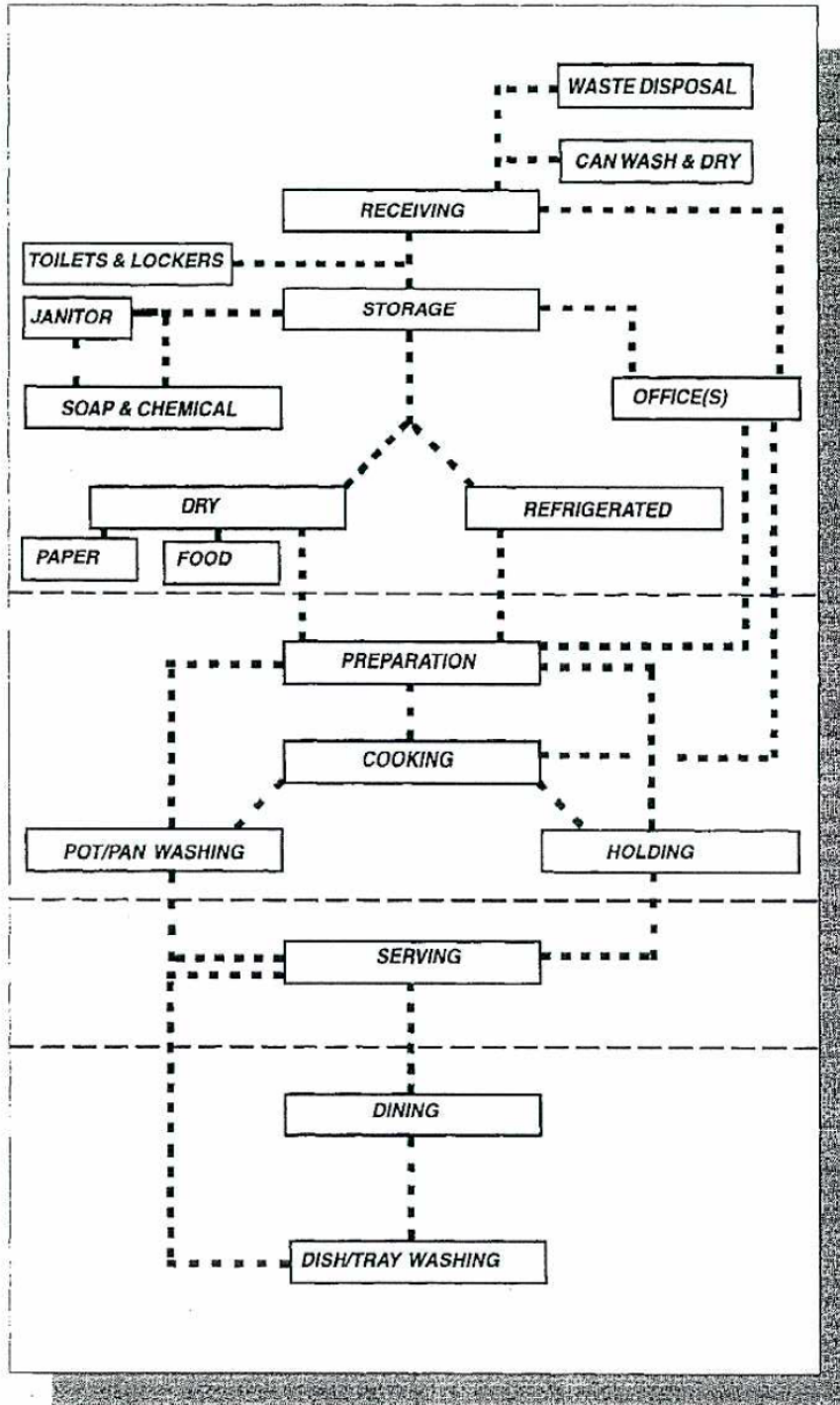

THIS PAGE INTENTIONALLY LEFT BLANK

14040-1. Square Footage Requirements

- 1.1. The maximum space allowance for a kitchen area includes space for food preparation, serving line(s), walk-in and reach-in refrigerator, walk-in and reach-in freezer, dry storage, dish washing, can washing, office, employee restrooms, receiving dock, and waste holding area. These areas are in conformance with the *Bureau of Indian Education Educational Space Criteria Handbook*.

Figure 14040-1: Maximum Space Allowance for Kitchen Area

Meals Served Per Day	Square Footage
100 or less	856
101–250	1261
251–500	1518
501–750	1938
751–1000	2208
1001–1250	2566
1251–1500	2880
1501–1750	3360
1751–2000	3840
2001 or more	4388

Source: *Equipment Guide for On-Site School Kitchens*, United States Department of Agriculture

THIS PAGE INTENTIONALLY LEFT BLANK

14050-1. Example Kitchen Layout Plans

- 1.1. The following floor plans and equipment schedules are for two different size schools. Floor Plan A accommodates serving approximately 450 meals a day. Floor Plan B accommodates serving approximately 1,200 meals a day. The type of equipment specified in the two plans is essentially the same; however, equipment quantities, and occasionally size, increase for the larger plan. These sample floor plans are for reference only and are not intended to limit the design options of the food service consultant.

Figure 14050-1: Kitchen Floor Plan A

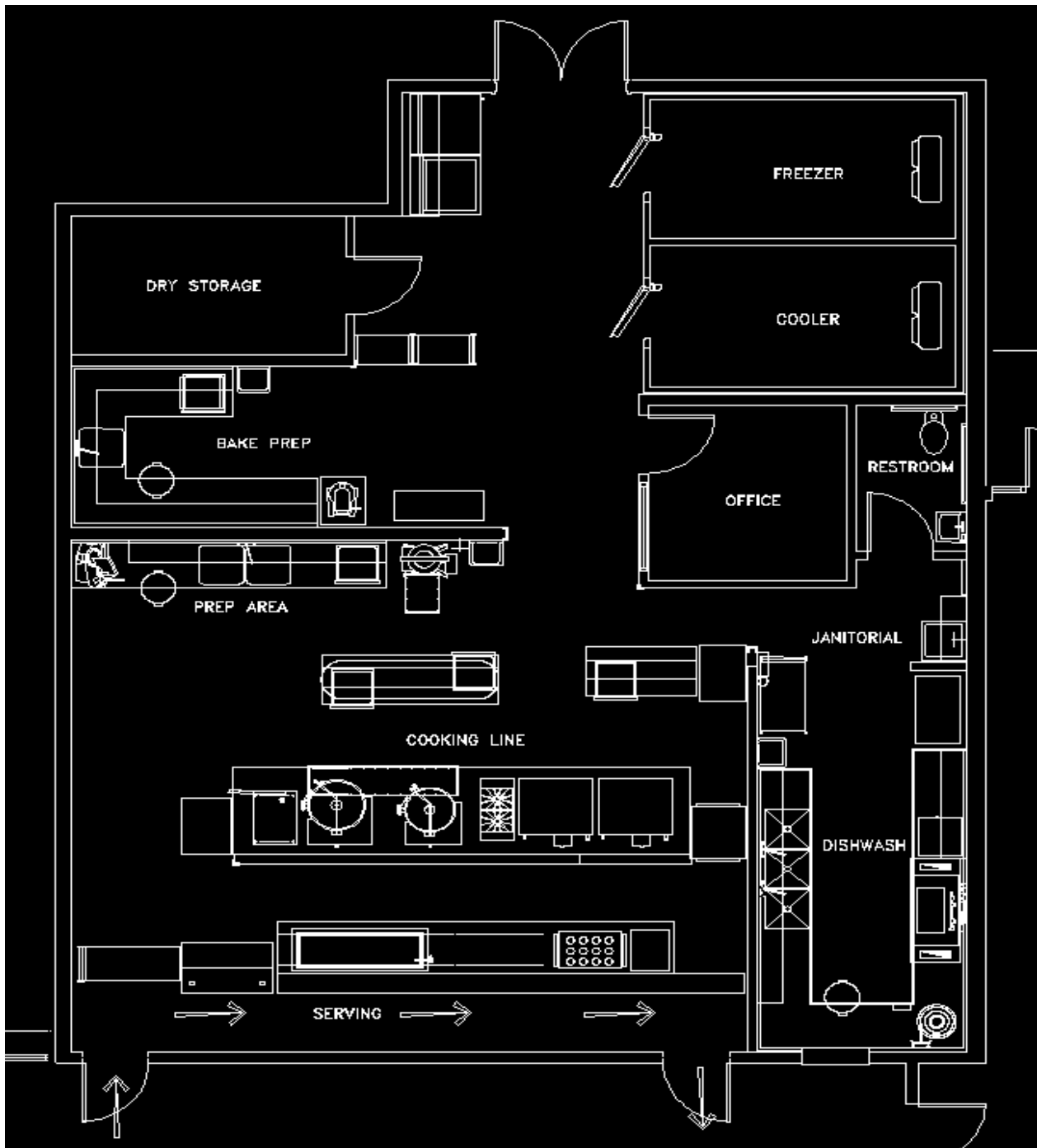

Figure 14050-2: Kitchen Floor Plan A Equipment Schedule

1	WALK-IN COOLER/FREEZER	1			
2	FREEZER CONDENSING UNIT	1			
3	FREEZER SHELVING	9			
4	COOLER CONDENSING UNIT	1			
5	COOLER SHELVING	9			
6	TRASH RECEPTACLE	LOT			
7	MOBILE MIXER STAND	1			
8	20 QUART MIXER	1			
9	SPARE NUMBER				
10	SPARE NUMBER				
11	PREP/BAKE TABLE WITH SINKS	1			
12	WALL SHELF WITH INGREDIENT RACKS	1			
13	MOBILE INGREDIENT BIN	3			
14	MICROWAVE OVEN	1			
15	DRY STORAGE SHELVING	7	49	WALL FLASHING	LOT
16	MOBILE CARTS	2	50	CORNER GUARDS	LOT
17	HAND SINK	3	51	FLOOR TROUGH W/ GRATE	1
18	PREP TABLE WITH SINKS AND DRAWERS	1	52	60 GALLON KETTLE	1
19	SPARE NUMBER		53	SPARE NUMBER	
20	SPARE NUMBER		54	SPARE NUMBER	
21	SPARE NUMBER		55	DOUBLE CONVECTION OVEN	2
22	WALL SHELF	1	56	FIRE SUPPRESSION SYSTEM	1
23	OVERHEAD UTENSIL RACK	1	57	PASS-THROUGH REFRIGERATOR	1
24	SLICER	1	58	SPARE NUMBER	
25	FLOOR TROUGH WITH GRATE	1	59	SPARE NUMBER	
26	VCM	1	60	SPARE NUMBER	
27	HOSE BIB	1	61	FRONT SERVING COUNTER	1
28	SPARE NUMBER		62	AIR CURTAIN DISPLAY CASE	2
29	SPARE NUMBER		63	FIVE HOT WELL SERVING COUNTER	2
30	SHELVING UNIT	1	64	SERVING COUNTER	2
31	WALL SHELF	1	65	SPARE NUMBER	
32	WASHER	1	66	MILK LOWERATOR	2
33	DRYER	1	67	P. O. S. STATION	1
34	WALL SHELF	1	68	P. O. S. EQUIPMENT	1
35	SPARE NUMBER		69	TRAY COUNTER	2
36	HOSE BIB	1	70	TRAY TRANSPORT CART	1
37	MOP RACK	1	71	SOILED DISH TABLE/ THREE COMP. SINK	1
38	MOBILE PROOF/ WARMER CABINET	1	72	WALL SHELF	1
39	SPARE NUMBER		73	MOBILE TRASH RECEPTACLE	1
40	SPARE NUMBER		74	PRE-RINSE	1
41	LANDING TABLE W/ DRAWERS	1	75	DISPOSER	1
42	BUN TOASTER	1	76	PULPER	1
43	SPARE NUMBER		77	HYDRO-SURGE UNIT	1
44	SPARE NUMBER		78	SPARE NUMBER	
45	MOBILE PAN RACKS	2	79	SPARE NUMBER	
46	PASS-THROUGH HOT BOX	1	80	SPARE NUMBER	
47	EXHAUST HOOD	1	81	SPARE NUMBER	
48	STEAMER	1	82	WALL SHELF	1
			83	POT SHELVING	1
			84	SPARE NUMBER	
			85	85 THROUGH 90 - SPARE NUMBER	

Figure 14050-3: Kitchen Floor Plan B

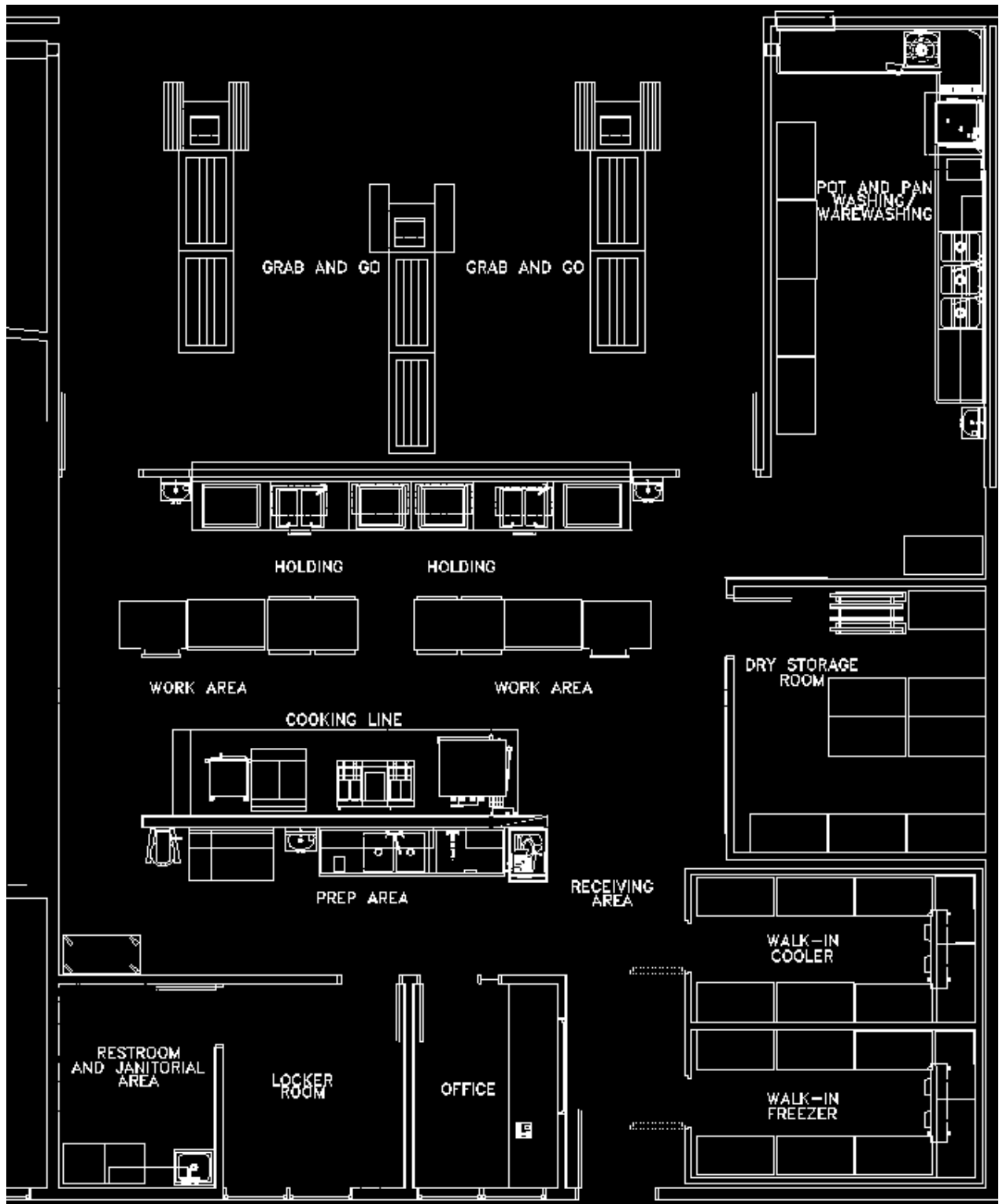

Figure 14050-4: Kitchen Floor Plan B Equipment Schedule

1	WALK-IN COOLER/FREEZER	1
2	COOLER COMPRESSOR	1
3	FREEZER COMPRESSOR	1
4	COOLER SHELVING	14
5	DUNNAGE RACK	2
6	COOLER COIL	1
7	FREEZER COIL	1
8	CAN RACK	1
9	SPARE NUMBER	-
10	SPARE NUMBER	-
11	SPARE NUMBER	-
12	DUNNAGE RACK	1
13	DRY STORAGE SHELVING	7
14	CORNER GUARD	LOT
15	WASHING MACHINE	1
16	CLOTHES DRYER	1
17	CHEMICAL SHELVING	1
18	MOP SINK	1
19	MOBILE PAN RACK	1
20	SPARE NUMBER	-
21	SPARE NUMBER	-
22	LOCKERS	8
23	OFFICE FURNITURE	LOT
24	MIXER	1
25	SPARE NUMBER	-
26	UNDER COUNTER REFRIGERATOR	1
27	SPARE NUMBER	-
28	WALL SHELF	1
29	SPARE NUMBER	-
30	SPARE NUMBER	-
31	SPARE NUMBER	-
32	HAND SINK	4
33	SOAP /TOWEL DISPENSER	4
34	CAN OPENER	1
35	WORK TABLE W/ SINK	1
36	WALL SHELF	1
37	DISPOSER WITH PRERINSE	1
38	SLICER STAND	1
39	SLICER	1
40	SPARE NUMBER	-
41	SPARE NUMBER	-
42	WALL SHELF	1
43	EXHAUST HOOD	1
44	FIRE SUPPRESSION	1
45	CONVECTION STEAMER	1
46	RANGE	1
47	FRYER ASSEMBLY	1
48	COMBI/CONVECTION OVEN	1
49	WALL FLASHING	LOT
46	RANGE	1
47	FRYER ASSEMBLY	1
48	COMBI/CONVECTION OVEN	1
49	WALL FLASHING	LOT
50	SPARE NUMBER	-
51	SPARE NUMBER	-
52	SPARE NUMBER	-
53	SPARE NUMBER	-
54	UNDER COUNTER REFRIGERATOR	2
55	U/C HEATED CABINET	2
56	SPARE NUMBER	-
57	SPARE NUMBER	-
58	WORK COUNTER	2
59	SPARE NUMBER	-
60	SPARE NUMBER	-
61	SERVING COUNTER	2
62	SERVING COUNTER	4
63	WARMER SHELF	2
64	SPARE NUMBER	-
65	SLANT SHELF WARMER	2
66	FOOD GUARD	2
67	FOOD GUARD	2
68	SHELVING	5
69	TRAY SLIDE	1
70	SPARE NUMBER	-
71	SPARE NUMBER	-
72	SOILED DISH TABLE	1
73	TRAY DOOR WINDOW	1
74	DISPOSER WITH PRERINSE	1
75	DISH MACHINE	1
76	CONDENSATE HOOD	1
77	BOOSTER HEATER	1
78	SPARE NUMBER	-
79	SPARE NUMBER	-
80	SPARE NUMBER	-
81	CLEAN DISH TABLE	1
82	WALL SHELF	1
83	SPARE NUMBER	-
84	AIR FLOW REFRIGERATED UNIT	4
85	P.O.S. SYSTEM	LOT
86	CASH COUNTER	3
87	SPARE NUMBER	-
88	SPARE NUMBER	-
89	SPARE NUMBER	-
90	CASHIER STOOL	3
91	SPARE NUMBER	-
92	SPARE NUMBER	-
93	93 - 100 SPARE NUMBER	-

THIS PAGE INTENTIONALLY LEFT BLANK

14060-1. Food Service Work Areas

- 1.1. **Receiving.** All deliveries will need to come in through the rear of the kitchen. The rear entrance should be a minimum of 42 inches wide and 8 feet high to allow for equipment and large deliveries. The receiving area should be close to the manager's office, the dry storage area, and the walk-in refrigerator and freezer. The receiving area should be wide enough to allow for packages and produce to be delivered and checked, and to allow for movement of people into and out of the area. If the rear entrance opens to the outdoors, a fan will be required to prevent flies and debris from entering the kitchen when the door(s) are open.
- 1.2. **Office.** The manager's office should be big enough for a desk, a chair, and filing cabinets. It should also include a data port and power outlet for a computer system. The office should contain a window that allows the manager to see into the kitchen work area and to monitor the rear entrance.
- 1.3. **Walk-In Refrigeration.** Every school should have an adequate amount of walk-in cooler and walk-in freezer storage. The amount of such cold-storage space should be planned based on usable shelving square footage—approximately 1 square foot of shelf space for each student meal divided equally between the cooler and the freezer. Walk-in boxes are very expensive to expand, so be generous with the initial amount of cold-storage space. If the school is in a rural area, double the size of refrigerated storage (i.e., 2 square feet of shelf space per student meal) to accommodate less frequent but larger deliveries made to such areas. The storage shelving used within cold storage areas should be rust resistant and antimicrobial. The longest recommended shelving span is 48 inches; shelves longer than that may bend or buckle. There should be dunnage racks incorporated into the shelving layout.
 - 1.3.1. Walk-in cooler panels will typically be 4 inches thick. The only exception is in the state of California, where 5-inch panels are required. In most cases, the walk-in boxes should sit in a 4-inch or 6-inch recessed pit. For a 6-inch recess, the architect should specify approximately 2-inch-thick finished floor materials, to be provided and installed by the general contractor.
 - 1.3.2. All compressors should be remote and semihermetic. If the compressor is to be located outdoors, provide outdoor housing for it and ensure that the unit can withstand extreme weather conditions. If the unit is to be housed within the building, ensure that it's specified as a water-cooled unit. Ensure that the refrigeration line is never more than 250 feet long.
- 1.4. **Restrooms and Lockers.** Provide an adequate amount of restroom and locker space for the kitchen staff. Verify requirements for restrooms and locker space with the local building and health departments.
- 1.5. **Dry-Storage Room.** Dry-storage space is calculated similarly to cold-storage space. Allow approximately 1 square foot of dry storage shelf space for each

student meal. For schools located in rural areas, allow extra dry-storage space to accommodate larger but less frequent deliveries to these schools. The room should be lockable to prevent food loss. To prevent rodents from damaging stored goods, the walls should be sealed and have no cracks. Stainless steel wire shelving is adequate for this area; to prevent bending and buckling, shelving spans should be no longer than 48 inches.

- 1.6. **Janitorial Room/Area.** If there is room, a separate janitorial room should be provided to house the mop sink, chemical storage, and such items. If space is limited, ensure that there is a low wall enclosing both sides of the mop sink to prevent soiled water from splashing into other areas. Provide the mop sink with a mop and broom rack, and with a service faucet mounted at approximately 54 inches above the finished floor. The mop sink should be constructed of stainless steel and be a minimum of 24 inches wide by 24 inches long.
- 1.7. **Food Preparation.** To streamline the work process, both the wet and dry food prep areas should be located close to the walk-in cooler and freezer. Provide a minimum of one 24-inch-long by 24-inch-wide by 19-inch-deep sink for each prep area. There should be drawers and undershelf storage provided wherever possible. Undercounter space should also be allotted for trash receptacles. Provide wall shelving wherever possible, mounted 24 inches above the counter height.
 - 1.7.1. Provide the following basic food prep appliances:
 - Food slicer
 - Large floor-mounted mixer
 - Small countertop mixer
 - Food processor
 - Blender
 - Ingredient bins
- 1.8. **Cooking Line.** The cooking line should be located out of sight of the serving line unless an exhibition cooking space is desired. All cooking equipment should be on front-lockable casters to allow for the equipment to be moved around. While the cooking equipment selected should accommodate the style of menu proposed by the food and beverage director, a typical cooking line consists of the following:
 - Six-burner range with oven
 - Tilt skillet
 - Jacketed steam kettle
 - Double-stacked convection oven
 - 1.8.1. ***Exhaust Hood.*** The cooking line should have an exhaust hood that overhangs the equipment per local fire codes. The bottom of the exhaust

hood should be a minimum of 6 feet 6 inches above the finished floor and a maximum of 7 feet 6 inches. Makeup air can be introduced through the front of the exhaust hood. Makeup air should be tempered to maintain appropriate indoor air temperature. The exhaust hood should be fabricated as follows:

- 1.8.1.1. The hood should be 18 gauge (1.3 mm) type 304 stainless steel external welded construction, in accordance with NFPA 96 Standard for Ventilation Control and Fire Protection of Commercial Cooking Operations, and the International Mechanical Code, including all applicable appendices. Exposed welds are to be ground and polished. Exhaust hoods are to be Underwriters Laboratories (UL) listed as available for length specified.
 - 1.8.1.2. Furnish the type of fixture specified. Fixtures are to be UL listed for cooking equipment exhaust hoods, National Sanitation Foundation approved, with sealed safety lenses, and with stainless steel exposed conduit for wiring.
 - 1.8.1.3. Furnish welded stainless steel formed duct collars at ceiling- or wall-duct connections. Before fabrication, verify the size and location of required duct connections.
 - 1.8.1.4. Provide a pre-piped liquid chemical or water fire suppressant system, complying with applicable local regulations and NFPA standards. Wet chemical fire suppression systems are to comply with UL 300 standards. Water fire suppression systems are to comply with UL 199E Standard for Safety for Fire Testing of Sprinklers and Water Spray Nozzles for Protection of Deep Fat Fryers.
 - 1.8.1.5. The water wash or ultraviolet control panel is to be made by the same manufacturer as the ventilator, with time clock control for automatic operation. Provide stainless steel trim strips for recessed control cabinet applications. Provide a stainless steel chase for a surface-mounted control panel, from the top of the panel to the ceiling, the full width and depth of the panel.
- 1.8.2. The cooking line should have work space or a chef's counter directly across from it, where cooks can temporarily place cooked food or perform tasks that don't require cooking equipment.
- 1.9. **Holding Area.** This is the area from which the serving line will be replenished. Any food that is prepped and cooked on the cooking line will go directly into a series of refrigerated, nonrefrigerated, or heated cabinets. It will remain there until it is moved to the serving line. This cabinet area should be close to the serving line and within sight of the cooking line. The chefs should be able to see into the cases and tell which items need to be restocked. Ideally, all holding area cabinets should be on lockable casters.

1.10. Serving Line. The serving line is where students will select and pay for their food. The serving line countertop should be at 34 inches above the finished floor and approximately 36 inches deep. It should also allow for a tray slide. The tray slide can be a 12-inch-deep rail running along the student's side of the counter, or it can be the countertop itself with a 12-inch extension to accommodate a tray. Equipment dropped into the counter or locations from where food will be served should be relatively close to the students.

1.10.1. Any serving area containing food that isn't covered by another means should have a sneeze guard over it. The sneeze guard should be either self-service or full-service style, depending on the type of service required. Clearances for sneeze guards should also comply with local health code requirements.

1.10.2. Typical serving line equipment is as follows:

- Drop-in cold pan
- Drop-in hot well
- Drop-in soup well

1.10.3. The above-listed basic equipment should be located at the serving line. The food and beverage team may also want to have displays for pre-packaged items and specialty foods. Depending on the size of the school, these "grab and go" areas can be anything from a countertop unit to a full "convenience store" area with display cases.

1.11. Pot and Pan Washing/Dishwashing Area. The ware washing or dishwashing area should generally be enclosed in its own area. This will be a very wet area and employee traffic into it should normally be limited to those dropping off soiled pots, pans, and trays. There should be access to it from the kitchen side and in most cases a drop-off window from the dining room side so students can drop off soiled dishes and trays.

1.11.1. The ware washing area should contain the following equipment:

- Three-compartment sink
- Storage shelving
- Soiled-dish table
- Ware washer
- Booster heater
- Garbage disposal
- Condensate hood
- Slant-rack shelving
- Clean-dish table

1.12. Miscellaneous Accessibility

- 1.12.1.** At least 50 percent, but no fewer than one, of each type of self-service shelf and dispensing device for tableware, dishware, condiments, food, and beverages at food service lines shall comply with ADAABAAG reach range criteria.
- 1.12.2.** When children ages 3 to 12 years of age are primary users of a dining area, each type of self-service shelf and dispensing device shall comply with ADAABAAG children reach ranges in accordance with applicable age groupings.
- 1.12.2.1. Note:** “Dual accessibility,” arranging single elements to serve the anthropometrics of more than one age group, could reduce the number shelves and devices required.

14060-2. Miscellaneous Items

- 2.1.** The following items are commonly overlooked when designing a commercial kitchen.

2.1.1. *Hand Sinks*

- 2.1.1.1.** These should be located within sight of every work station. Ensure that a soap and towel dispenser is provided at each station. If any hand sink is located within 30 inches of a food prep area or work station, provide a 12-inch-high stainless steel splash guard.

2.1.2. *Aisle Widths*

- 2.1.2.1.** If a cart or truck will be passing two workers back to back, the aisle should be 60 inches wide plus the cart width.
- 2.1.2.2.** If there will be only one person working in an area, the aisle width should be 36 inches.
- 2.1.2.3.** If there will be one person passing another person working at a station, the aisle width should be 42 inches.
- 2.1.2.4.** If two people will be working back to back, the aisle should be 42 to 44 inches wide.
- 2.1.2.5.** If there will be one person passing two workers back to back, the aisle width should be 48 inches.

2.1.3. *Corner Guards*

- 2.1.3.1.** Stainless steel corner guards should be located on all exposed corners within the kitchen.

THIS PAGE INTENTIONALLY LEFT BLANK

14070-1. General Metal Fabrication Requirements

- 1.1. Remove burrs from sheared edges of metalwork, ease the corners, and smooth to eliminate cutting hazard. Bend sheets of metal at not less than the minimum radius required to avoid grain separation in the metal. Maintain flat, smooth surfaces, without damage to the finish.
- 1.2. Reinforce metal at locations of hardware, anchorages, and accessory attachments wherever metal is less than 14 gauge or requires mortised application. Conceal reinforcements to the greatest extent possible. Weld in place, on concealed faces.
- 1.3. Exposed screw or bolt heads, rivets, and butt joints made by riveting straps under seams and then filling them with solder will not be accepted. Where fasteners are permitted, provide Phillips-head, flat, or oval-head machine screws. Cap threads with acorn nuts unless they are fully concealed in inaccessible construction, and provide nuts and lock washers unless metal for tapping is at least 12 gauge. Match fastener head finish with the finish of the metal fastened.
- 1.4. Where components of fabricated metalwork are to be galvanized and involve welding or machining of metal heavier than 16 gauge, complete the fabrication and provide hot-dip galvanizing of each component, after fabrication, to the greatest extent possible (depending upon available dip-tank sizes). Comply with ASTM A123 Standard Specification for Zinc (Hot-Dip Galvanized) Coatings on Iron and Steel Products.
- 1.5. **Welding and Soldering**
 - 1.5.1. Materials 18 gauge or heavier are to be welded.
 - 1.5.2. Seams and joints are to be shop welded or soldered as the nature of the material may require.
 - 1.5.3. Welds are to be ground smooth and polished to match the original finish.
 - 1.5.4. Where galvanizing has been burned off, the weld is to be cleaned and touched up with high-grade aluminum paint.
 - 1.5.5. Provide removable panels for access to mechanical and electrical service connections that are concealed behind or within food service equipment, but only where access is not possible and not indicated through other work.
 - 1.5.6. Where the ends of fixtures, splashbacks, shelves, etc., are open, fill them by forming the metal or by welding sections, if necessary, to close the entire opening flush to walls or adjoining fixtures.
 - 1.5.7. Rolled edges are to be as detailed, with corners bull-nosed, ground, and polished.

- 1.5.8. Equipment is to have 1/2-inch or larger radius coves in horizontal and vertical corners and intersections, per National Sanitation Foundation standards.

1.6. **Metal and Gauges**

- 1.6.1. Except as otherwise indicated, all exposed metalwork shall be fabricated of stainless steel, of the gauge indicated for the following components. Fabricate other components from not less than 20-gauge metal.

Tables and countertops	14 gauge
Sinks and drainboards	14 gauge
Shelves	16 gauge
Fronts of drawers and door panels	18 gauge
Single-pan doors and drawer fronts	16 gauge
Enclosed base cabinets	18 gauge
Enclosed wall cabinets	18 gauge
Exhaust hoods and ventilators	18 gauge
Pan-type insets and trays	16 gauge
Removable covers and panels	18 gauge
Skirts and enclosure panels	18 gauge
Closure and trim strips over 4" wide	18 gauge
Hardware reinforcement	12 gauge
Gusset plates	10 gauge